



THE DATASHEET OF SMA6J48CA



**SURFACE MOUNT GPP
TRANSIENT VOLTAGE SUPPRESSOR
600 WATT PEAK POWER 5.0 WATTS STEADY STATE**

FEATURES

- * Plastic package has underwriters laboratory
- * Glass passivated chip construction
- * 600 watt surge capability at 1ms
- * Excellent clamping capability
- * Low zener impedance
- * Fast response time
- * P/N suffix V means AEC-Q101 qualified
- * P/N suffix V means Halogen-free

Ratings at 25°C ambient temperature unless otherwise specified.

MAXIMUM RATINGS AND ELECTRICAL CHARACTERISTICS

Ratings at 25°C ambient temperature unless otherwise specified.



DO-214AC

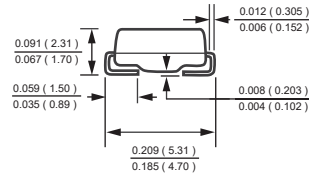
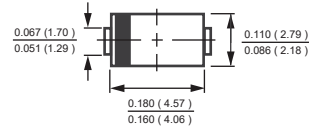

Dimensions in inches and (millimeters)

DEVICES FOR BIPOLAR APPLICATIONS

For Bidirectional use C or CA suffix for types SMA6J5.0 thru SMA6J550

Electrical characteristics apply in both direction

MAXIMUM RATINGS (At TA = 25°C unless otherwise noted)

RATINGS	SYMBOL	VALUE	UNITS
Peak Power Dissipation with a 10/1000uS (Note 1,2, Fig.1)	PPPM	Minimum 600	Watts
Peak Pulse Current with a 10/1000uS waveform (Note 1, Fig.3)	I _{PPM}	SEE TABLE 1	Amps
Steady State Power Dissipation at TL = 75°C (Note 2)	P _{M(AV)}	5.0	Watts
Peak Forward Surge Current 8.3mS single half sine-wave superimposed on rated load (JEDEC method) (Note 2,3) unidirectional only	I _{FSM}	100	Amps
Typical Current Squared Time	i ² t	41.5	A ² S
Maximum Instantaneous Forward Voltage at 50A for unidirectional only (Note 4,5)	V _F	SEE NOTE 5	Volts
Operating and Storage Temperature Range	T _J , T _{STG}	-55 to + 150	°C

- NOTES : 1. Non-repetitive current pulse, per Fig.3 and derated above TA = 25°C per Fig.2.
 2. Mounted on 0.2 X 0.2 (5.0 X 5.0mm) copper pad to each terminal.
 3. Lead temperature at TL = 25°C
 4. Measured on 8.3mS single half sine-wave duty cycle = 4 pulses per minute maximum.
 5. V_F = 3.5V on SMA6J-5.0 thru SMA6J-90 devices and V_F = 5.0V on SMA6J-100 thru SMA6J-550 devices.

RATING AND CHARACTERISTIC CURVES (SMA6J5.0 THRU SMA6J550CA)

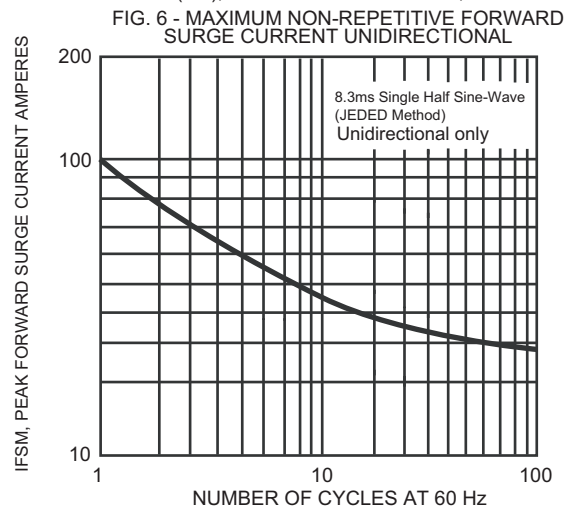
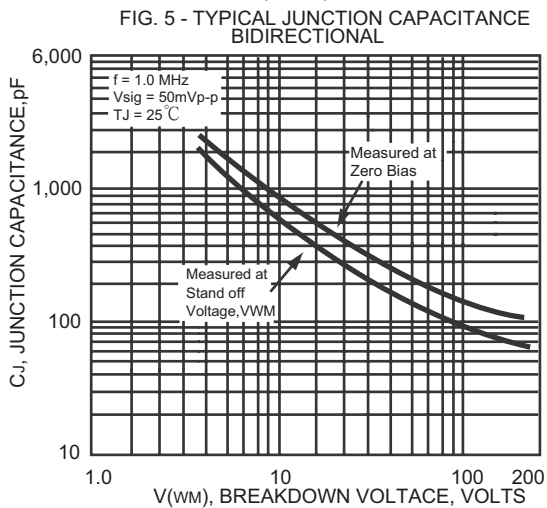
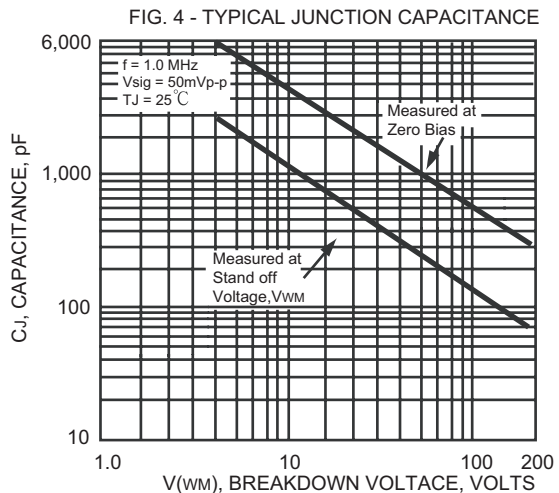
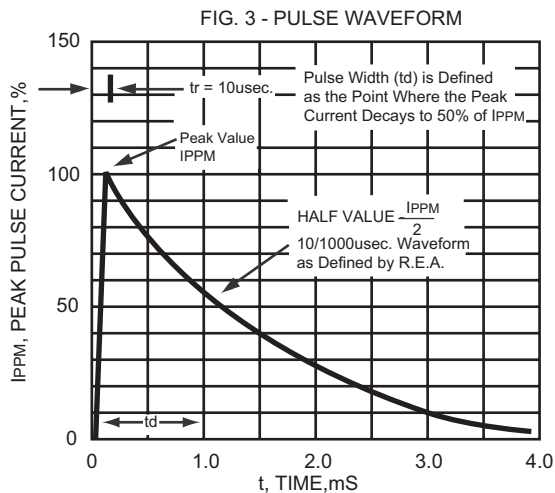
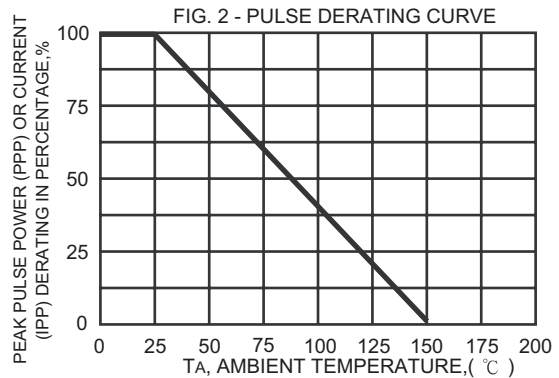
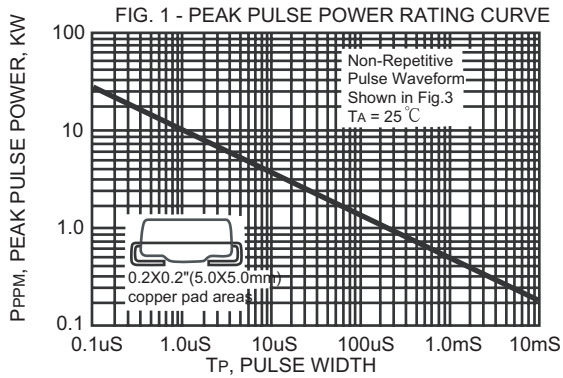

TRANSIENT VOLTAGE SUPPRESSORS

600W SERIES TVS DIODES / DO-214AC (CASE 3) 600W

Rectron Industry No.	Rectron House No.	Breakdown Voltage			Reverse Stand off Voltage VWM (Volts)	Maximum Reverse Leakage at VWM ID(uA)	Maximum Peak Pulse Current IPPM (Amps)	Maximum Clamping Voltage at IPPM VC (Volts)
		VBR (Volts)		@IT (mA)				
		MIN.	MAX.					
SMA6J5.0	TFMA6J5.0	6.40	7.82	10	5.0	20.0	62.5	9.6
SMA6J5.0A	TFMA6J5.0A	6.40	7.07	10	5.0	20.0	65.2	9.2
SMA6J6.0	TFMA6J6.0	6.67	8.15	10	6.0	20.0	52.6	11.4
SMA6J6.0A	TFMA6J6.0A	6.67	7.37	10	6.0	20.0	58.3	10.3
SMA6J6.5	TFMA6J6.5	7.22	8.82	10	6.5	20.0	48.8	12.3
SMA6J6.5A	TFMA6J6.5A	7.22	7.98	10	6.5	20.0	53.6	11.2
SMA6J7.0	TFMA6J7.0	7.78	9.51	10	7.0	20.0	45.1	13.3
SMA6J7.0A	TFMA6J7.0A	7.78	8.60	10	7.0	20.0	50.0	12.0
SMA6J7.5	TFMA6J7.5	8.33	10.2	1.0	7.5	20.0	42.0	14.3
SMA6J7.5A	TFMA6J7.5A	8.33	9.21	1.0	7.5	20.0	46.5	12.9
SMA6J8.0	TFMA6J8.0	8.89	10.9	1.0	8.0	20.0	40.0	15.0
SMA6J8.0A	TFMA6J8.0A	8.89	9.83	1.0	8.0	20.0	44.1	13.6
SMA6J8.5	TFMA6J8.5	9.44	11.5	1.0	8.5	20.0	37.7	15.9
SMA6J8.5A	TFMA6J8.5A	9.44	10.4	1.0	8.5	20.0	41.7	14.4
SMA6J9.0	TFMA6J9.0	10.0	12.2	1.0	9.0	10.0	35.5	16.9
SMA6J9.0A	TFMA6J9.0A	10.0	11.1	1.0	9.0	10.0	39.0	15.4
SMA6J10	TFMA6J10	11.1	13.6	1.0	10.0	5.0	31.9	18.8
SMA6J10A	TFMA6J10A	11.1	12.3	1.0	10.0	5.0	35.3	17.0
SMA6J11	TFMA6J11	12.2	14.9	1.0	11.0	1.0	29.9	20.1
SMA6J11A	TFMA6J11A	12.2	13.5	1.0	11.0	1.0	33.0	18.2
SMA6J12	TFMA6J12	13.3	16.3	1.0	12.0	1.0	27.3	22.0
SMA6J12A	TFMA6J12A	13.3	14.7	1.0	12.0	1.0	30.2	19.9
SMA6J13	TFMA6J13	14.4	17.6	1.0	13.0	1.0	25.2	23.8
SMA6J13A	TFMA6J13A	14.4	15.9	1.0	13.0	1.0	27.9	21.5
SMA6J14	TFMA6J14	15.6	19.1	1.0	14.0	1.0	23.3	25.8
SMA6J14A	TFMA6J14A	15.6	17.2	1.0	14.0	1.0	25.9	23.2
SMA6J15	TFMA6J15	16.7	20.4	1.0	15.0	1.0	22.3	26.9
SMA6J15A	TFMA6J15A	16.7	18.5	1.0	15.0	1.0	24.6	24.4
SMA6J16	TFMA6J16	17.8	21.8	1.0	16.0	1.0	20.8	28.8
SMA6J16A	TFMA6J16A	17.8	19.7	1.0	16.0	1.0	23.1	26.0
SMA6J17	TFMA6J17	18.9	23.1	1.0	17.0	1.0	19.7	30.5
SMA6J17A	TFMA6J17A	18.9	20.9	1.0	17.0	1.0	21.7	27.6
SMA6J18	TFMA6J18	20.0	24.4	1.0	18.0	1.0	18.6	32.2
SMA6J18A	TFMA6J18A	20.0	22.1	1.0	18.0	1.0	20.5	29.2
SMA6J20	TFMA6J20	22.2	27.1	1.0	20.0	1.0	16.8	35.8
SMA6J20A	TFMA6J20A	22.2	24.5	1.0	20.0	1.0	18.5	32.4
SMA6J22	TFMA6J22	24.4	29.8	1.0	22.0	1.0	15.2	39.4
SMA6J22A	TFMA6J22A	24.4	26.9	1.0	22.0	1.0	16.9	35.5
SMA6J24	TFMA6J24	26.7	32.6	1.0	24.0	1.0	14.0	43.0
SMA6J24A	TFMA6J24A	26.7	29.5	1.0	24.0	1.0	15.4	38.9
SMA6J26	TFMA6J26	28.9	35.3	1.0	26.0	1.0	12.9	46.6
SMA6J26A	TFMA6J26A	28.9	31.9	1.0	26.0	1.0	14.3	42.1
SMA6J28	TFMA6J28	31.1	38.0	1.0	28.0	1.0	12.0	50.0
SMA6J28A	TFMA6J28A	31.1	34.4	1.0	28.0	1.0	13.2	45.4
SMA6J30	TFMA6J30	33.3	40.7	1.0	30.0	1.0	11.2	53.5
SMA6J30A	TFMA6J30A	33.3	36.8	1.0	30.0	1.0	12.4	48.4
SMA6J33	TFMA6J33	36.7	44.9	1.0	33.0	1.0	10.2	59.0
SMA6J33A	TFMA6J33A	36.7	40.6	1.0	33.0	1.0	11.3	53.3
SMA6J36	TFMA6J36	40.0	48.9	1.0	36.0	1.0	9.3	64.3
SMA6J36A	TFMA6J36A	40.0	44.2	1.0	36.0	1.0	10.3	58.1

TRANSIENT VOLTAGE SUPPRESSORS

600W SERIES TVS DIODES / DO-214AC (CASE 3) 600W

Rectron Industry No.	Rectron House No.	Breakdown Voltage			Reverse Stand off Voltage V_{WM} (Volts)	Maximum Reverse Leakage at V_{WM} I_D (μ A)	Maximum Peak Pulse Current IPPM (Amps)	Maximum Clamping Voltage at IPPM V_C (Volts)
		VBR (Volts)		@ I_T (mA)				
		MIN.	MAX.					
SMA6J40	TFMA6J40	44.4	54.3	1.0	40	1.0	71.4	
SMA6J40A	TFMA6J40A	44.4	49.1	1.0	40	1.0	64.5	
SMA6J43	TFMA6J43	47.8	58.4	1.0	43	1.0	76.7	
SMA6J43A	TFMA6J43A	47.8	52.8	1.0	43	1.0	69.4	
SMA6J45	TFMA6J45	50.0	61.1	1.0	45	1.0	80.3	
SMA6J45A	TFMA6J45A	50.0	55.3	1.0	45	1.0	72.7	
SMA6J48	TFMA6J48	53.3	65.1	1.0	48	1.0	85.5	
SMA6J48A	TFMA6J48A	53.3	58.9	1.0	48	1.0	77.4	
SMA6J51	TFMA6J51	56.7	69.3	1.0	51	1.0	91.1	
SMA6J51A	TFMA6J51A	56.7	62.7	1.0	51	1.0	82.4	
SMA6J54	TFMA6J54	60.0	73.3	1.0	54	1.0	96.3	
SMA6J54A	TFMA6J54A	60.0	66.3	1.0	54	1.0	87.1	
SMA6J58	TFMA6J58	64.4	78.7	1.0	58	1.0	103	
SMA6J58A	TFMA6J58A	64.4	71.2	1.0	58	1.0	93.6	
SMA6J60	TFMA6J60	66.7	81.5	1.0	60	1.0	107	
SMA6J60A	TFMA6J60A	66.7	73.7	1.0	60	1.0	96.8	
SMA6J64	TFMA6J64	71.1	86.9	1.0	64	1.0	114	
SMA6J64A	TFMA6J64A	71.1	78.6	1.0	64	1.0	103	
SMA6J70	TFMA6J70	77.8	95.1	1.0	70	1.0	125	
SMA6J70A	TFMA6J70A	77.8	86.0	1.0	70	1.0	113	
SMA6J75	TFMA6J75	83.3	102	1.0	75	1.0	134	
SMA6J75A	TFMA6J75A	83.3	92.1	1.0	75	1.0	121	
SMA6J78	TFMA6J78	86.7	106	1.0	78	1.0	139	
SMA6J78A	TFMA6J78A	86.7	95.8	1.0	78	1.0	126	
SMA6J85	TFMA6J85	94.4	115	1.0	85	1.0	151	
SMA6J85A	TFMA6J85A	94.4	104	1.0	85	1.0	137	
SMA6J90	TFMA6J90	100	122	1.0	90	1.0	160	
SMA6J90A	TFMA6J90A	100	111	1.0	90	1.0	146	
SMA6J100	TFMA6J100	111	136	1.0	100	1.0	179	
SMA6J100A	TFMA6J100A	111	123	1.0	100	1.0	162	
SMA6J110	TFMA6J110	122	149	1.0	110	1.0	196	
SMA6J110A	TFMA6J110A	122	135	1.0	110	1.0	177	
SMA6J120	TFMA6J120	133	163	1.0	120	1.0	214	
SMA6J120A	TFMA6J120A	133	147	1.0	120	1.0	193	
SMA6J130	TFMA6J130	144	176	1.0	130	1.0	231	
SMA6J130A	TFMA6J130A	144	159	1.0	130	1.0	209	
SMA6J150	TFMA6J150	167	204	1.0	150	1.0	268	
SMA6J150A	TFMA6J150A	167	185	1.0	150	1.0	243	
SMA6J160	TFMA6J160	178	218	1.0	160	1.0	287	
SMA6J160A	TFMA6J160A	178	197	1.0	160	1.0	259	
SMA6J170	TFMA6J170	189	231	1.0	170	1.0	304	
SMA6J170A	TFMA6J170A	189	209	1.0	170	1.0	275	

- Notes :
1. V_{BR} measured after I_T applied for 300ms. I_T = square pulse or equivalent.
 2. For bidirectional use C or CA suffixs for all types (ex. SMA6J5.0C,SMA6J170CA) electrical characteristics apply in both directions.
 3. For bidirectional types having V_{WM} of 10 volts and less, the I_D limit is doubled.

TRANSIENT VOLTAGE SUPPRESSORS

600W SERIES TVS DIODES / DO-214AC (CASE 3) 600W

Rectron Industry No.	Rectron House No.	Breakdown Voltage			Reverse Stand off Voltage V_{WM} (Volts)	Maximum Reverse Leakage at V_{WM} I_D (μ A)	Maximum Peak Pulse Current IPPM (Amps)	Maximum Clamping Voltage at IPPM V_C (Volts)
		V_{BR} (Volts)		$@I_T$ (mA)				
		MIN.	MAX.					
SMA6J180A	TFMA6J180A	201	222	1.0	180	1.0	292	
SMA6J190A	TFMA6J190A	209	243	1.0	190	1.0	308	
SMA6J200A	TFMA6J200A	224	247	1.0	200	1.0	324	
SMA6J210A	TFMA6J210A	231	268	1.0	210	1.0	340	
SMA6J220A	TFMA6J220A	246	272	1.0	220	1.0	358	
SMA6J250A	TFMA6J250A	279	309	1.0	250	1.0	405	
SMA6J300A	TFMA6J300A	335	371	1.0	300	1.0	486	
SMA6J350A	TFMA6J350A	391	432	1.0	350	1.0	567	
SMA6J400A	TFMA6J400A	447	494	1.0	400	1.0	648	
SMA6J440A	TFMA6J440A	492	543	1.0	440	1.0	713	
SMA6J480A	TFMA6J480A	536	593	1.0	480	1.0	750	
SMA6J520A	TFMA6J520A	578	640	1.0	520	1.0	762	
SMA6J550A	TFMA6J550A	615	680	1.0	550	1.0	860	

- Notes :
1. V_{BR} measured after I_T applied for 300ms. I_T = square pulse or equivalent.
 2. For bidirectional use C or CA suffixs for all types (ex. SMA6J5.0C,SMA6J170CA) electrical characteristics apply in both directions.
 3. For bidirectional types having V_{WM} of 10 volts and less, the I_D limit is doubled.

Mounting Pad Layout

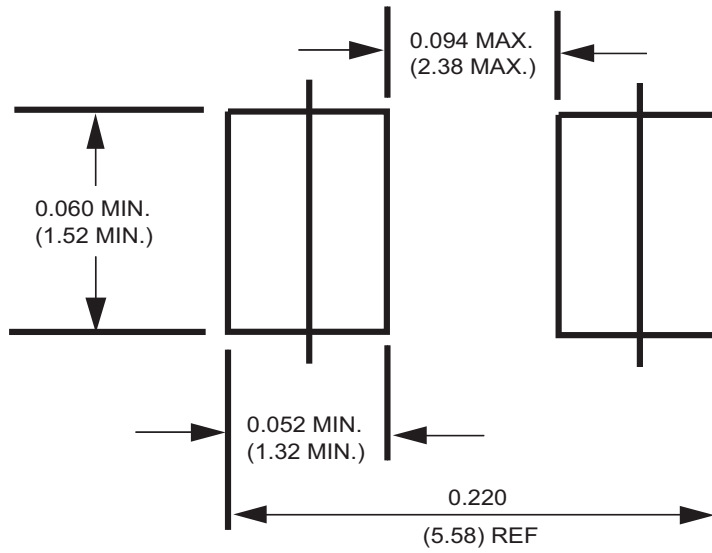

Dimensions in inches and (millimeters)

REEL TAPING SPECIFICATIONS FOR SURFACE MOUNT DEVICES-FLAT MELF (SMA/SMB/SMC)

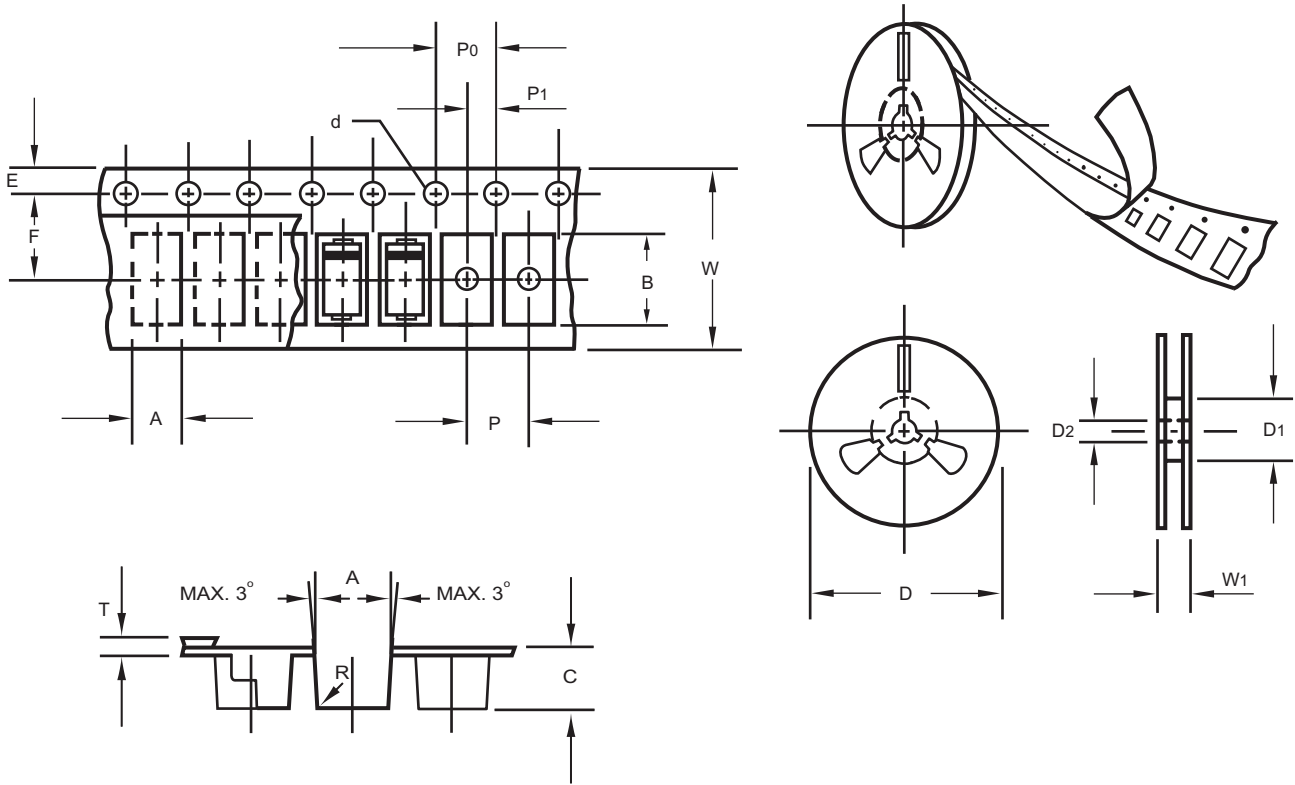

Fig.: Configuration of FLAT MELF TAPING
(SMA/SMB/SMC)

ITEM	SYMBOL	DO214AC (SMA) mm(inch)	DO214AA (SMB) mm(inch)	DO214AB (SMC) mm(inch)
Carrier width	A	2.6 ± 0.15 (.102 ± .006)	3.65 ± 0.1 (.144 ± .004)	6.0 ± 0.1 (.236 ± .004)
Carrier length	B	5.15 ± 0.15 (.203 ± .006)	5.69 ± 0.1 (.224 ± .004)	8.30 ± 0.1 (.327 ± .004)
Carrier depth	C	2.3 ± 0.15 (.091 ± .006)	2.67 ± 0.1 (.105 ± .004)	2.5 ± 0.1 (.098 ± .004)
Sprocket hole	d	1.5 ± 0.1 (.059 ± .004)	1.5 ± 0.1 (.059 ± .004)	1.5 ± 0.1 (.059 ± .004)
Reel outside diameter	D	178 ± 2.0 (7.0 ± .079)	178 ± 2.0 (7.0 ± .079)	178 ± 2.0 (7.0 ± .079)
Reel inner diameter	D1	50 Min.	50 Min.	50 Min.
Feed hole diameter	D2	13 ± 0.5 (.512 ± .020)	13 ± 0.5 (.512 ± .020)	13 ± 0.5 (.512 ± .020)
Strocket hole position	E	1.5 ± 0.1 (.059 ± .004)	1.5 ± 0.1 (.059 ± .004)	1.5 ± 0.1 (.059 ± .004)
Punch hole position	F	5.65 ± 0.05 (.222 ± .002)	5.65 ± 0.05 (.222 ± .002)	7.65 ± 0.05 (.301 ± .002)
Punch hole pitch	P	4.0 ± 0.1 (.157 ± .004)	8.0 ± 0.1 (.315 ± .004)	8.0 ± 0.1 (.315 ± .004)
Sprocket hole pitch	P0	4.0 ± 0.1 (.157 ± .004)	4.0 ± 0.1 (.157 ± .004)	4.0 ± 0.1 (.157 ± .004)
Embossment center	P1	2.0 ± 0.1 (.079 ± .004)	2.0 ± 0.1 (.079 ± .004)	4.0 ± 0.1 (.157 ± .004)
Total tape thickness	T	0.30 ± .05 (.012 ± .002)	0.6 Max.	0.6 Max.
Tape width	W	12.0 ± 0.2 (.472 ± .008)	12.0 ± 0.2 (.472 ± .008)	16.0 ± 0.2 (.630 ± .008)
Reel width	W1	16.8 ± 2.0 (.661 ± .079)	16.8 ± 2.0 (.661 ± .079)	24.0 ± 2.0 (.945 ± .079)

Notes: 1.Devices are packed in accordance with EIA standard RS-481-A and specification given above.
2.Available on 7 inch (1500 ct.) or 13 inch (5000 ct.) diameter reels.

PACKAGING OF DIODE AND BRIDGE RECTIFIERS

REEL PACK

PACKAGE	PACKING CODE	EA PER REEL	EA PER INNER BOX	COMPONENT SPACE (mm)	TAPE SPACE (mm)	REEL DIA (mm)	CARTON SIZE (mm)	EA PER CARTON	GROSS WEIGHT(Kg)
SMA	-W	7,500	15,000	---	---	330	360*355*360	120,000	15.2

PACKAGE	PACKING CODE	EA PER REEL	EA PER INNER BOX	COMPONENT SPACE (mm)	TAPE SPACE (mm)	REEL DIA (mm)	CARTON SIZE (mm)	EA PER CARTON	GROSS WEIGHT(Kg)
SMA	-T	2,000	8,000	---	---	178	390*205*310	64,000	7.8



Attachment information about SMA6JXXX

1. Internal Circuit



2. Marking on the body

2.1 UNIDIRECTIONAL

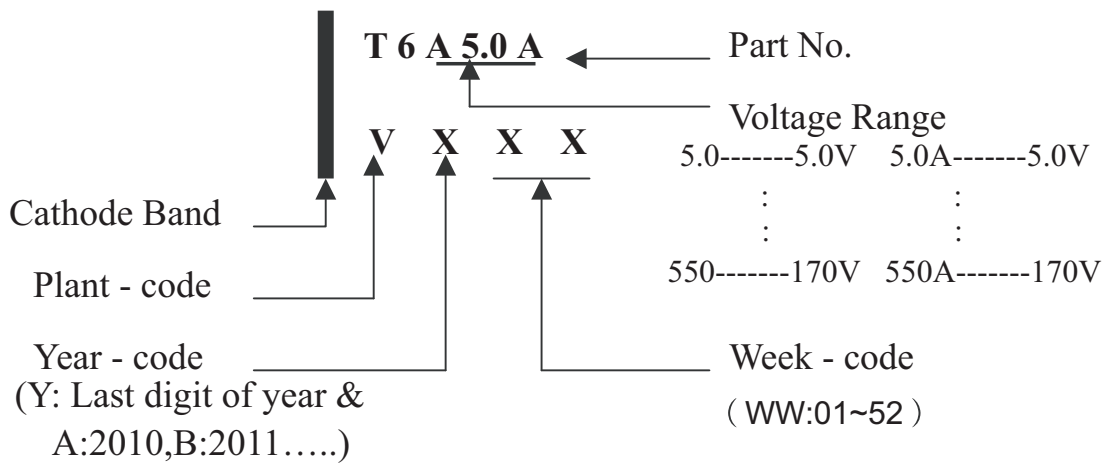

2.2 BIDIRECTIONAL

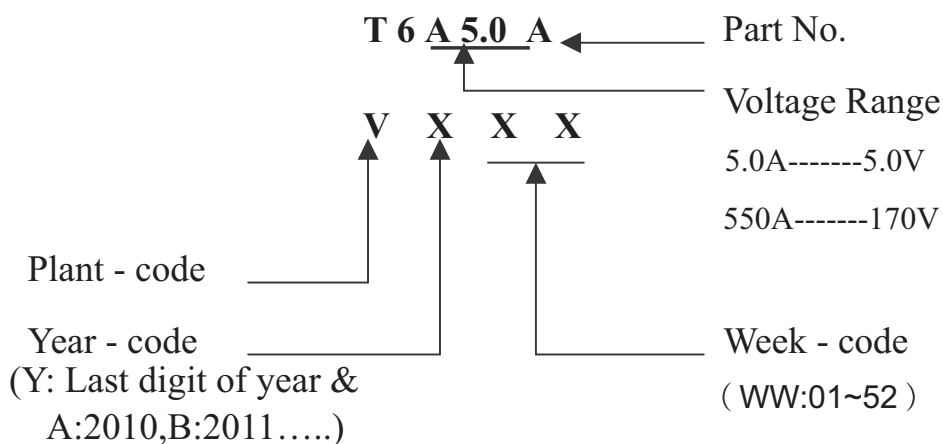



DISCLAIMER NOTICE

Rectron Inc reserves the right to make changes without notice to any product specification herein, to make corrections, modifications, enhancements or other changes. Rectron Inc or anyone on its behalf assumes no responsibility or liability for any errors or inaccuracies. Data sheet specifications and its information contained are intended to provide a product description only. "Typical" parameters which may be included on RECTRON data sheets and/ or specifications can and do vary in different applications and actual performance may vary over time. Rectron Inc does not assume any liability arising out of the application or use of any product or circuit.

Rectron products are not designed, intended or authorized for use in medical, life-saving implant or other applications intended for life-sustaining or other related applications where a failure or malfunction of component or circuitry may directly or indirectly cause injury or threaten a life without expressed written approval of Rectron Inc. Customers using or selling Rectron components for use in such applications do so at their own risk and shall agree to fully indemnify Rectron Inc and its subsidiaries harmless against all claims, damages and expenditures.

Looking for pricing, stock, or lifecycle information?

Click below to explore more details on WIN SOURCE:

-  [View SMA6J48CA on WIN SOURCE](#)
-  [Rectron USA Information](#)

Optimize Your Supply Chain with WIN SOURCE Solutions

-  Global Sourcing Solution
-  Obsolete Management
-  Cost Control Management
-  Shortage Management
-  Alternative Solution
-  Excess Inventory Management