

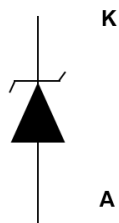

THE DATASHEET OF SMB6F85AY

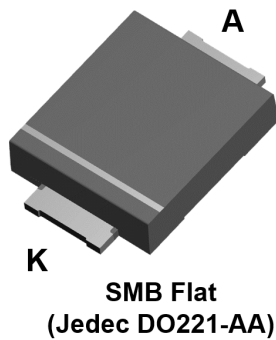

Automotive 600 W TVS in SMB Flat



Unidirectional

Product status link	
SMB6FY	SMB6F5.0AY , SMB6F6.0AY , SMB6F6.5AY , SMB6F8.5AY , SMB6F10AY , SMB6F11AY , SMB6F13AY , SMB6F12AY , SMB6F14AY , SMB6F15AY , SMB6F16AY , SMB6F18AY , SMB6F20AY , SMB6F22AY , SMB6F23AY , SMB6F24AY , SMB6F26AY , SMB6F28AY , SMB6F30AY , SMB6F31AY , SMB6F33AY , SMB6F36AY , SMB6F40AY , SMB6F48AY , SMB6F58AY , SMB6F70AY , SMB6F85AY , SMB6F100AY , SMB6F130AY , SMB6F154AY , SMB6F170AY , SMB6F188AY

Features

- AEC-Q101 qualified 
- Peak pulse power: 600 W (10/1000 μ s) and 4 kW (8/20 μ s)
- Flat and thin package: 1 mm
- Stand-off voltage range from 5 V to 188 V
- Unidirectional type
- Low leakage current: 0.2 μ A at 25 °C and 1 μ A at 85 °C
- Operating T_j max: 175 °C
- High power capability at T_j max.: up to 470 W (10/1000 μ s)
- Lead finishing: matte tin plating

Complies with the following standards

- UL94, V0
- J-STD-020 MSL level 1
- J-STD-002, JESD 22-B102 E3 and MIL-STD-750, method 2026 solderable matte tin plated leads
- JESD-201 class 2 whisker test
- IPC7531 footprint
- JEDEC registered package outline
- IEC 61000-4-4 level 4:
 - 4 kV
- ISO10605, IEC 61000-4-2, C= 150 pF - R = 330 Ω exceeds level 4:
 - 30 kV (air discharge)
 - 30 kV (contact discharge)
- ISO10605 - C = 330 pF, R = 330 Ω exceeds level 4:
 - 30 kV (air discharge)
 - 30 kV (contact discharge)
- ISO7637-2 (Not applicable to parts with stand-off voltage lower than battery voltage)
 - Pulse1: $V_S = -150$ V
 - Pulse 2a: $V_S = +112$ V
 - Pulse 3a: $V_S = -220$ V
 - Pulse 3b: $V_S = +150$ V

Description

The SMB6FxxAY series are designed to protect sensitive automotive circuits against surges defined in ISO 7637-2 and against electrostatic discharges according to ISO 10605.

The Planar technology makes it compatible with high-end circuits where low leakage current and high junction temperature are required to provide long term reliability and stability.

1 Characteristics

Table 1. Absolute maximum ratings ($T_{amb} = 25\text{ }^{\circ}\text{C}$)

Symbol	Parameter	Value	Unit	
V_{PP}	Peak pulse voltage	ISO10605 (C = 330 pF, R = 330 Ω):	kV	
		Contact discharge		30
		Air discharge		30
		ISO10605 / IEC 61000-4-2 (C = 150 pF, R = 330 Ω):		
	Contact discharge	30		
	Air discharge	30		
P_{PP}	Peak pulse power dissipation	10/1000 μs , T_j initial = T_{amb}	600	W
T_{stg}	Storage temperature range		-65 to +175	$^{\circ}\text{C}$
T_j	Operating junction temperature range		-55 to +175	$^{\circ}\text{C}$
T_L	Maximum lead temperature for soldering during 10 s		260	$^{\circ}\text{C}$

Figure 1. Electrical characteristics - parameter definitions

- V_{RM} Maximum stand-off voltage
- I_{RM} Maximum leakage current @ V_{RM}
- V_R Stand-off voltage
- I_R Leakage current @ V_R
- V_{BR} Breakdown voltage @ I_{BR}
- I_{BR} Breakdown current
- V_{CL} Clamping voltage @ I_{PP}
- I_{PP} Peak pulse current
- R_D Dynamic resistance
- V_F Forward voltage drop @ I_F
- I_F Forward current
- αT Voltage temperature coefficient



Figure 2. Pulse definition for electrical characteristics



Table 2. Electrical characteristics - parameter values (T_{amb} = 25 °C, unless otherwise specified)

Type	I _{RM} max at V _{RM}			V _{BR} at I _{BR} ⁽¹⁾				10 / 1000 μs			8 / 20 μs			αT
	25 °C	85 °C		Min.	Typ.	Max.		V _{CL} ⁽²⁾⁽³⁾	I _{PP} ⁽⁴⁾	R _D	V _{CL} ⁽²⁾⁽³⁾	I _{PP} ⁽⁴⁾	R _D	
	μA	V		V			mA	V	A	Ω	V	A	Ω	Max.
								Max.		Max.	Max.		Max.	Max.
SMB6F5.0AY	20	50	5.0	6.4	6.74	7.1	10	9.2	68	0.031	13.4	298	0.021	5.7
SMB6F6.0AY	20	50	6.0	6.7	7.05	7.4	10	10.3	61	0.048	13.7	290	0.022	5.9
SMB6F6.5AY	20	50	6.5	7.2	7.58	8	10	11.2	56	0.057	14.5	276	0.024	6.1
SMB6F8.5AY	20	50	8.5	9.4	9.9	10.4	1	14.4	41.7	0.096	19.5	205	0.044	7.3
SMB6F10AY	0.2	1	10	11.1	11.7	12.3	1	17	37	0.127	21.7	184	0.051	7.8
SMB6F11AY	0.2	1	11	12.3	13	13.7	1	18	33.8	0.127	24.2	1665	0.064	8.1
SMB6F12AY	0.2	1	12	13.3	14	14.7	1	19.9	31	0.168	25.3	157	0.068	8.3
SMB6F13AY	0.2	1	13	14.4	15.2	16	1	21.5	29	0.190	27.2	147	0.076	8.4
SMB6F14AY	0.2	1	14	15.7	16.5	17.3	1	23.1	26	0.223	29	136	0.086	8.6
SMB6F15AY	0.2	1	15	16.7	17.6	18.5	1	24.4	25.1	0.235	32.5	123	0.114	8.8
SMB6F16AY	0.2	1	16	17.9	18.8	19.8	1	26	23.1	0.268	34.7	115	0.130	9.0
SMB6F18AY	0.2	1	18	20	21.1	22.2	1	29.2	21.5	0.326	39.3	102	0.168	9.2
SMB6F20AY	0.2	1	20	22.2	23.4	24.6	1	32.4	19.4	0.402	42.8	93	0.196	9.4
SMB6F22AY	0.2	1	22	24.4	25.7	27	1	35.5	17.7	0.480	48.3	83	0.257	9.6
SMB6F23AY	0.2	1	23	25.7	27	28.4	1	37.8	16.4	0.573	49.2	81	0.257	9.6
SMB6F24AY	0.2	1	24	26.7	28.1	29.5	1	38.9	16	0.588	50	80	0.256	9.6
SMB6F26AY	0.2	1	26	28.9	30.4	31.9	1	42.1	14.9	0.685	53.5	75	0.288	9.7
SMB6F28AY	0.2	1	28	31.1	32.7	34.3	1	45.4	13.8	0.804	59	68	0.363	9.8
SMB6F30AY	0.2	1	30	33.2	35	36.8	1	48.4	13	0.885	64.3	62	0.442	9.9
SMB6F31AY	0.2	1	31	34.2	36	37.8	1	50.2	12.3	1.01	65	61	0.45	9.9
SMB6F33AY	0.2	1	33	36.7	38.6	40.5	1	53.3	11.8	1.08	69.7	57	0.512	10
SMB6F36AY	0.2	1	36	40	42.1	44.2	1	58.1	10.3	1.35	76	52	0.612	10
SMB6F40AY	0.2	1	40	44.4	46.7	49	1	64.5	9.7	1.60	84	48	0.729	10.1
SMB6F48AY	0.2	1	48	53.2	56	58.8	1	77.4	8.1	2.28	100	40	1.03	10.3
SMB6F58AY	0.2	1	58	64.6	68	71.4	1	93.6	6.7	3.34	121	33	1.51	10.4
SMB6F70AY	0.2	1	70	77.9	82	86.1	1	113	5.5	4.91	146	27	2.22	10.5
SMB6F85AY	0.2	1	85	95	100	105	1	137	4.6	7.17	178	22.5	3.29	10.6
SMB6F100AY	0.2	1	100	111	117	123	1	162	3.8	10.3	212	19	4.68	10.7
SMB6F130AY	0.2	1	130	144	152	160	1	209	3	16.3	265	15	7	10.8
SMB6F154AY	0.2	1	154	171	180	189	1	246	2.4	23.8	317	12.6	10.2	10.8
SMB6F170AY	0.2	1	170	190	200	210	1	275	2.2	30	353	11.3	12.7	10.8
SMB6F188AY	0.2	1	188	209	220	231	1	328	2	48.5	388	10.3	15.2	10.8

1. To calculate V_{BR} versus T_j: V_{BR} at T_j = V_{BR} at 25 °C x (1 + αT x (T_j - 25))
2. To calculate V_{CL} versus T_j: V_{CL} at T_j = V_{CL} at 25 °C x (1 + αT x (T_j - 25))
3. To calculate V_{CL} max versus I_{PPappli}: V_{CLmax} = V_{BR} max + RD x I_{PPappli}
4. Surge capability given for both directions

1.1 Characteristics (curves)

Figure 3. Maximum peak power dissipation versus initial junction temperature

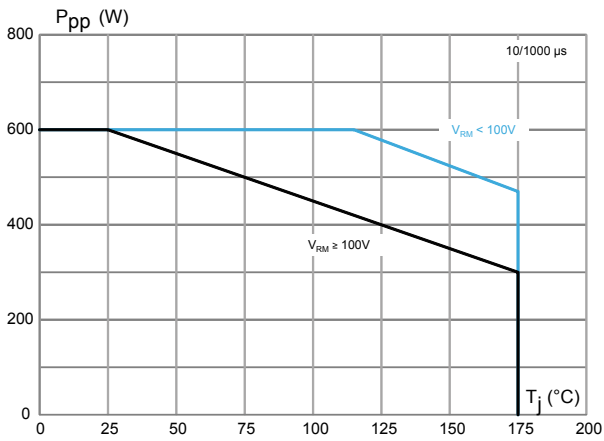

Figure 4. Maximum peak pulse power versus exponential pulse duration

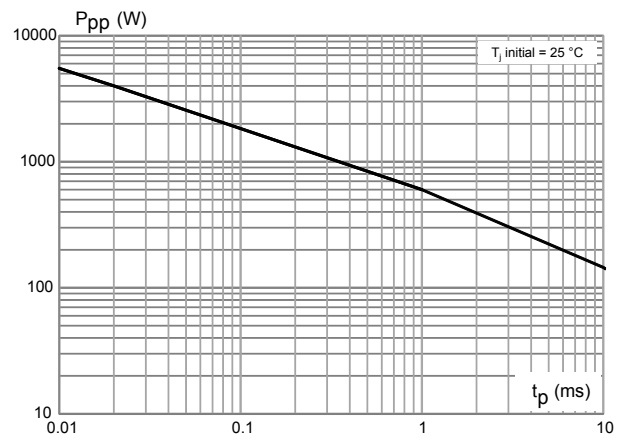

Figure 5. Maximum peak pulse current versus clamping voltage

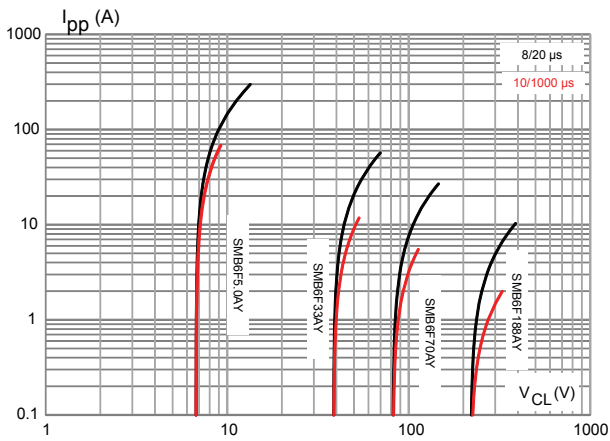

Figure 6. Dynamic resistance versus pulse duration

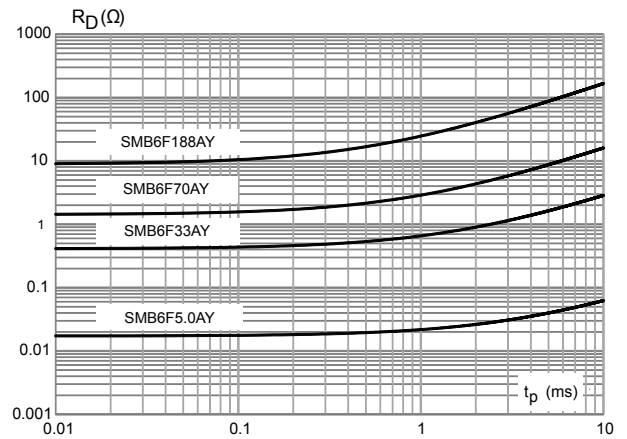

Figure 7. Junction capacitance versus reverse applied voltage (unidirectional types)

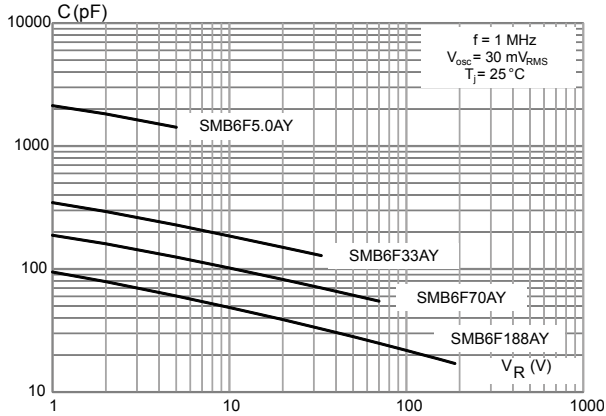

Figure 8. Leakage current versus junction temperature

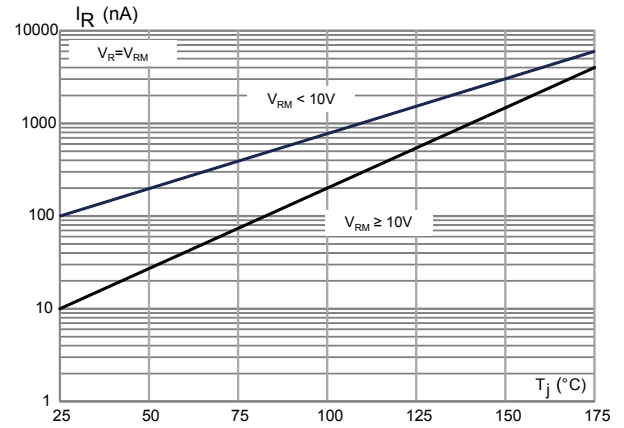

Figure 9. Peak forward voltage drop versus peak forward current

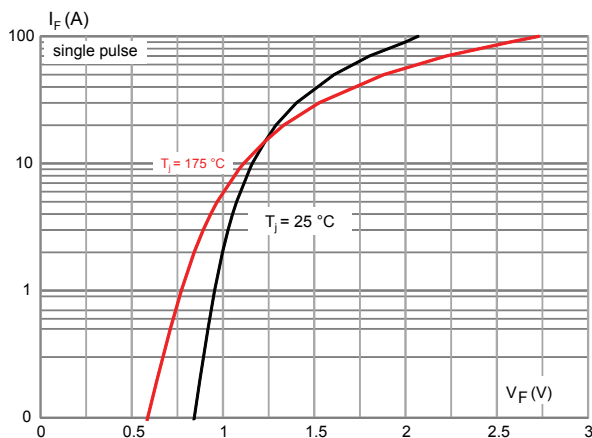

Figure 10. Thermal impedance junction to ambient versus pulse duration

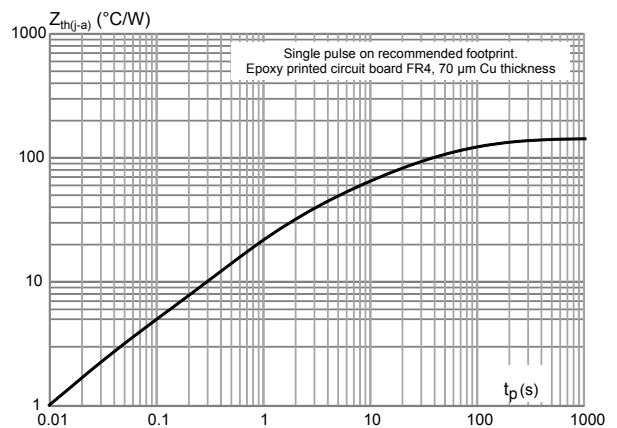

Figure 11. Thermal resistance junction to ambient versus copper area under each lead (SMB Flat)

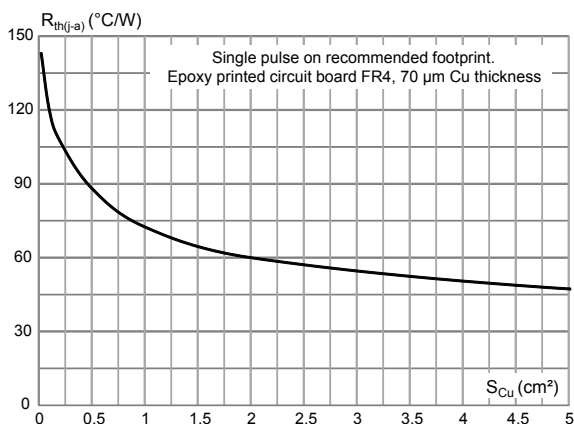

Figure 12. ISO7637-2 pulse 1: Vs = -150 V with 12 V battery

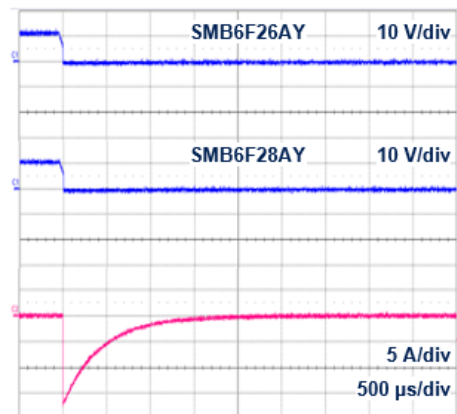

Figure 13. ISO7637-2 pulse 2a: $V_s = +112\text{ V}$ with 12 V battery

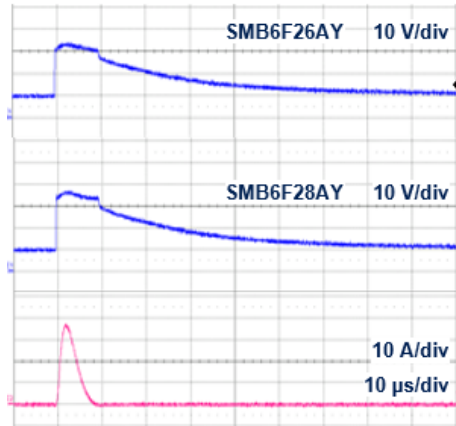

Figure 14. ISO7637-2 pulse 3a: $V_s = -220\text{ V}$ with 12 V battery

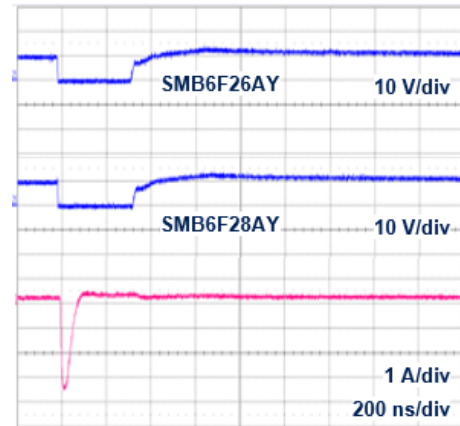
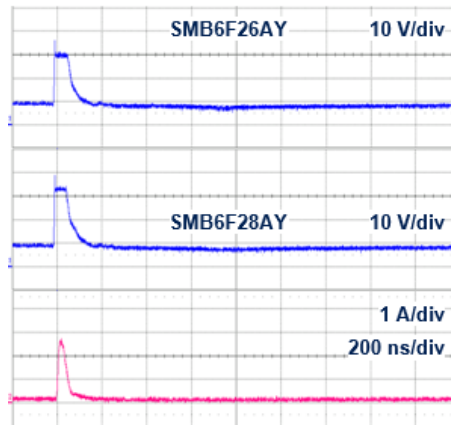

Figure 15. ISO7637-2 pulse 3b: $V_s = +150\text{ V}$ with 12 V battery



2 Package information

In order to meet environmental requirements, ST offers these devices in different grades of **ECOPACK®** packages, depending on their level of environmental compliance. ECOPACK® specifications, grade definitions and product status are available at: www.st.com. ECOPACK® is an ST trademark.

2.1 SMB Flat package information

Figure 16. SMB Flat package outline

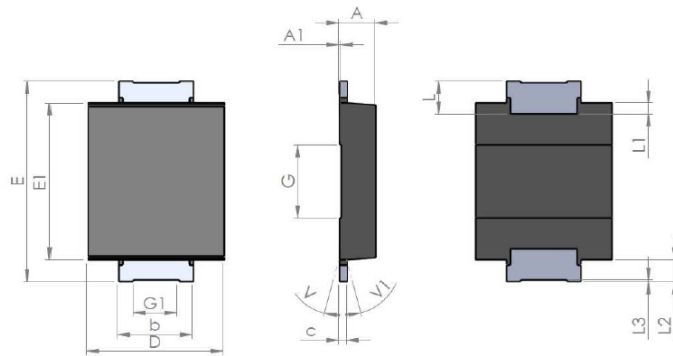

Table 3. SMB Flat mechanical data

Ref.	Dimensions					
	Millimeters			Inches ⁽¹⁾		
	Min.	Typ.	Max.	Min.	Typ.	Max.
A	0.90		1.10	0.035		0.044
A1		0.05			0.002	
b	1.95		2.20	0.076		0.087
c	0.15		0.40	0.005		0.016
D	3.30		3.95	0.129		0.156
E	5.20		5.60	0.204		0.221
E1	4.05		4.60	0.159		0.182
G		2.00			0.079	
G1		1.20			0.047	
L	0.75		1.20	0.029		0.048
L1		0.30			0.012	
L2		0.60			0.024	
L3	0.02			0.000		
V			8°			8°
V1			8°			8°

1. Values in inches are converted from mm and rounded to 3 decimal digits.

Figure 17. Footprint recommendations, dimensions in mm (inches)

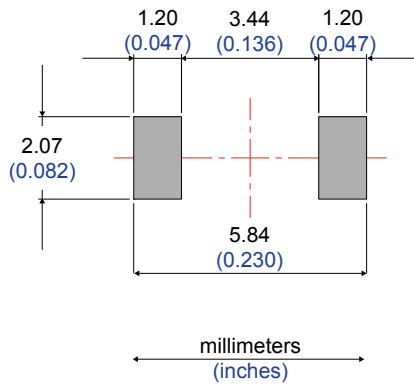

Figure 18. Marking layout (refer to ordering information table for marking)

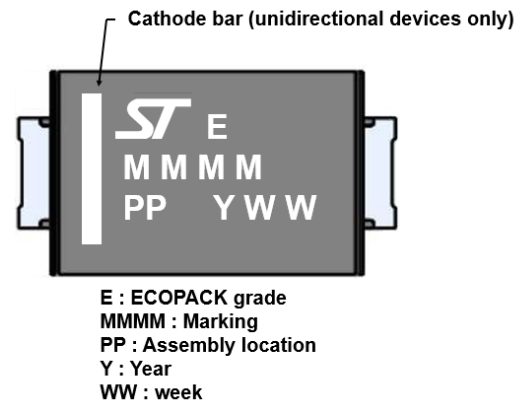
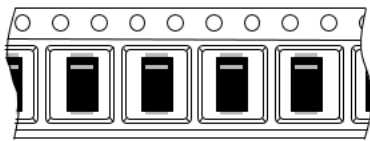

Figure 19. Package orientation in reel



Taped according to EIA-481
Note: Pocket dimensions are not on scale
Pocket shape may vary depending on package
On bidirectional devices, marking and logo may be not always in the same direction

Figure 20. Tape and reel orientation

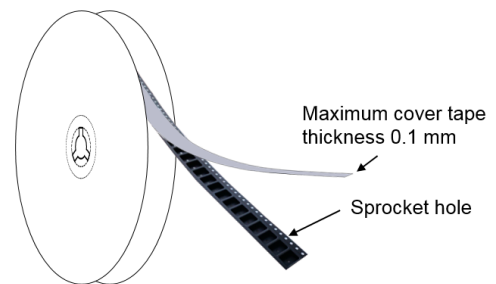

Figure 21. Reel dimensions (mm)

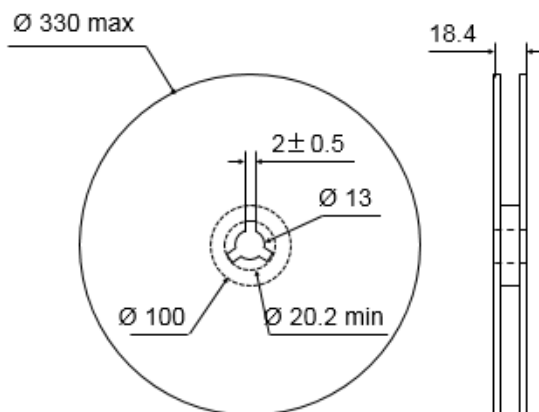

Figure 22. Inner box dimensions (mm)

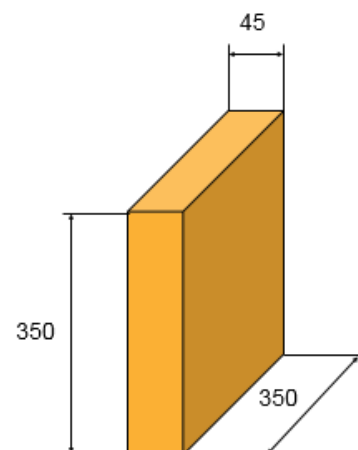
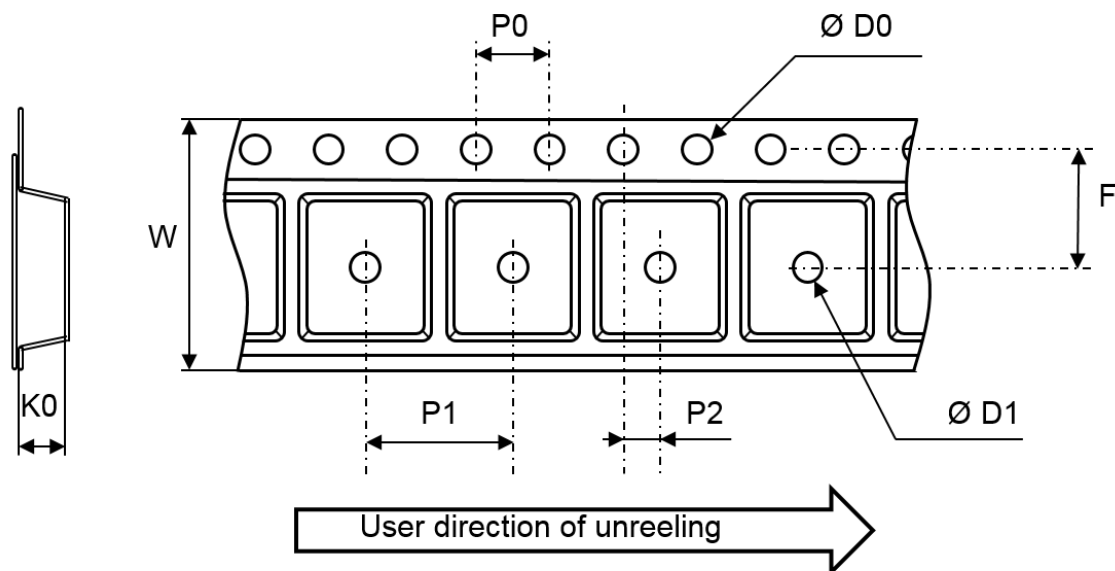

Figure 23. Tape and reel outline



Note: Pocket dimensions are not on scale
Pocket shape may vary depending on package

Table 4. Tape and reel mechanical data

Ref.	Dimensions		
	Millimeters		
	Min.	Typ.	Max.
ØD0	1.45	1.50	1.55
ØD1	1.5		
F	5.4	5.5	5.6
K0	1.2	1.3	1.4
P0	3.9	4.0	4.1
P1	7.9	8.0	8.1
P2	1.9	2.0	2.1
W	11.7	12.0	12.3

2.2 Reflow profile

Figure 24. ST ECOPACK[®] recommended soldering reflow profile for PCB mounting

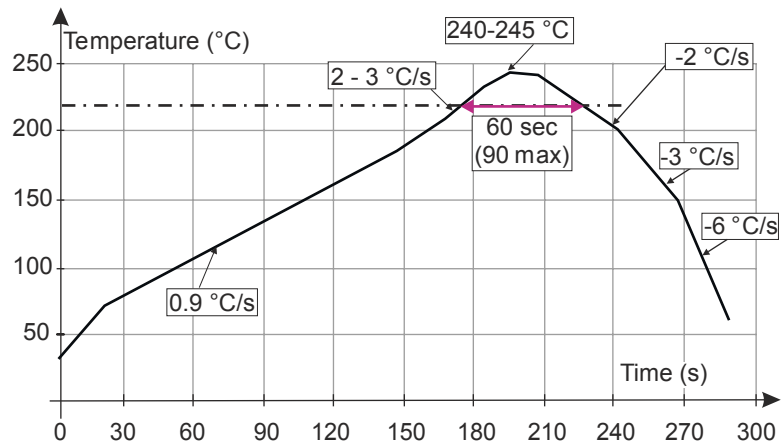

Note: Minimize air convection currents in the reflow oven to avoid component movement. Maximum soldering profile corresponds to the latest IPC/JEDEC J-STD-020.

3 Application and design guidelines

More information is available in the application note AN2689 “Protection of automotive electronics from electrical hazards, guidelines for design and component selection”.

4 SMB6FY Ordering information

Figure 25. Ordering information scheme

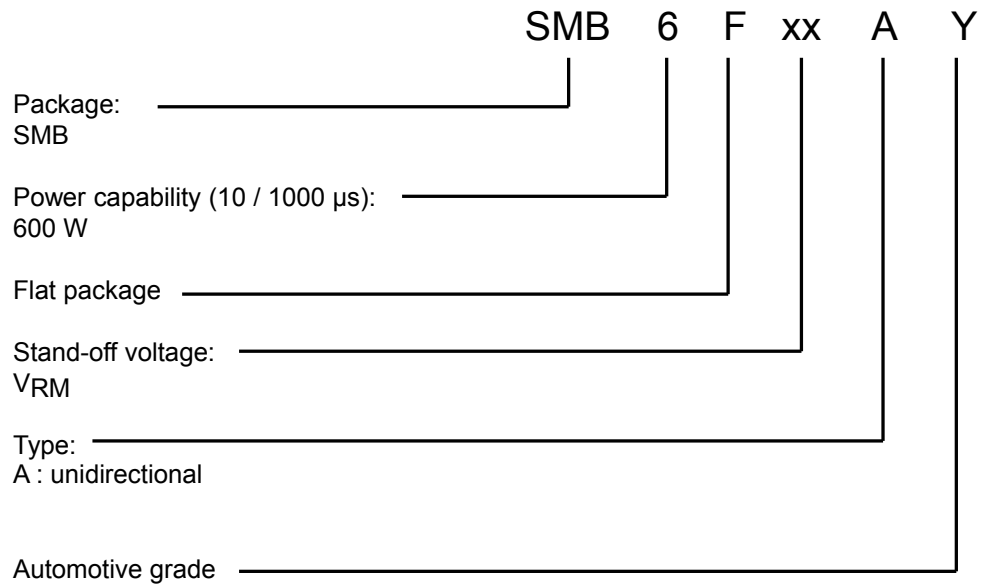

Table 5. Ordering information

Order code	Marking	Package	Weight	Base qty.	Delivery mode
SMB6FxxAY	See Table 6. Marking.	SMB Flat	56 mg	5000	Tape and reel

4.1 Marking

Table 6. Marking

Order code	Marking
SMB6F5.0AY	7AIY
SMB6F6.0AY	7AKY
SMB6F6.5AY	7ALY
SMB6F8.5AY	7APY
SMB6F10AY	7ASY
SMB6F11AY	7AUY
SMB6F12AY	7AWY
SMB6F13AY	7AYY
SMB6F14AY	7BAY
SMB6F15AY	7BCY
SMB6F16AY	7BEY
SMB6F18AY	7BIY
SMB6F20AY	7BMY
SMB6F22AY	7BOY
SMB6F23AY	7BPY
SMB6F24AY	7BQY
SMB6F26AY	7BSY
SMB6F28AY	7BUY
SMB6F30AY	7BWY
SMB6F31AY	7BXY
SMB6F33AY	7BZY
SMB6F36AY	7CCY
SMB6F40AY	7CGY
SMB6F48AY	7COY
SMB6F58AY	7CYY
SMB6F70AY	7DKY
SMB6F85AY	7DZY
SMB6F100AY	7EOY
SMB6F130AY	7FSY
SMB6F154AY	7GQY
SMB6F170AY	7HGY
SMB6F188AY	7HYY

Revision history

Table 7. Document revision history

Date	Revision	Changes
11-Jan-2019	1	Initial release.

IMPORTANT NOTICE – PLEASE READ CAREFULLY

STMicroelectronics NV and its subsidiaries (“ST”) reserve the right to make changes, corrections, enhancements, modifications, and improvements to ST products and/or to this document at any time without notice. Purchasers should obtain the latest relevant information on ST products before placing orders. ST products are sold pursuant to ST’s terms and conditions of sale in place at the time of order acknowledgement.

Purchasers are solely responsible for the choice, selection, and use of ST products and ST assumes no liability for application assistance or the design of Purchasers’ products.

No license, express or implied, to any intellectual property right is granted by ST herein.

Resale of ST products with provisions different from the information set forth herein shall void any warranty granted by ST for such product.

ST and the ST logo are trademarks of ST. All other product or service names are the property of their respective owners.

Information in this document supersedes and replaces information previously supplied in any prior versions of this document.

© 2019 STMicroelectronics – All rights reserved

Looking for pricing, stock, or lifecycle information?

Click below to explore more details on WIN SOURCE:

-  [View SMB6F85AY](#) on WIN SOURCE
-  [STMicroelectronics](#) Information

Optimize Your Supply Chain with WIN SOURCE Solutions

-  Global Sourcing Solution
-  Obsolete Management
-  Cost Control Management
-  Shortage Management
-  Alternative Solution
-  Excess Inventory Management