

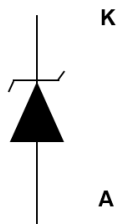

THE DATASHEET OF SMA6F20A

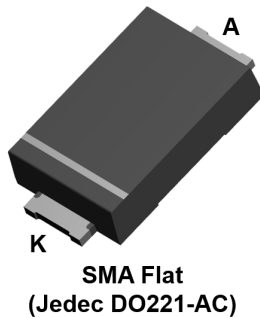



Unidirectional

Features

- Peak pulse power: 600 W (10/1000 μ s) and 4 kW (8/20 μ s)
- Stand-off voltage range from 5 V to 188 V
- Unidirectional type
- Low leakage current: 0.2 μ A at 25 °C and 1 μ A at 85 °C
- Operating T_j max: 175 °C
- High power capability at T_j max.: up to 400 W (10/1000 μ s)
- Lead finishing: matte tin plating

Complies with the following standards

- UL94, V0
- J-STD-020 MSL level 1
- J-STD-002, JESD 22-B102 E3 and MIL-STD-750, method 2026
- JESD-201 class 2 whisker test
- IPC7531 footprint and JEDEC registered package outline
- IEC 61000-4-2, C = 150 pF - R = 330 Ω exceeds level 4:
 - 25 kV (contact discharge)
 - 30 kV (air discharge)

Description

The SMA6F Transil series are designed to protect sensitive circuits against transient surges.

The planar technology makes it compatible with high-end circuits where low leakage current and high junction temperature are required to provide long term reliability and stability.

Product status link	
SMA6F	SMA6F5.0A , SMA6F6.0A , SMA6F6.5A , SMA6F8.5A , SMA6F10A , SMA6F11A , SMA6F12A , SMA6F13A , SMA6F14A , SMA6F15A , SMA6F16A , SMA6F18A , SMA6F20A , SMA6F22A , SMA6F23A , SMA6F24A , SMA6F26A , SMA6F28A , SMA6F30A , SMA6F31A , SMA6F33A , SMA6F36A , SMA6F40A , SMA6F48A , SMA6F58A , SMA6F70A , SMA6F85A , SMA6F100A , SMA6F130A , SMA6F154A , SMA6F170A , SMA6F188A

1 Characteristics

Table 1. Absolute maximum ratings ($T_{amb} = 25\text{ }^{\circ}\text{C}$)

Symbol	Parameter	Value	Unit	
V_{PP}	Peak pulse voltage	IEC 61000-4-2 (C = 150 pF, R = 330 Ω)		
		Contact discharge	25	kV
		Air discharge	30	
P_{PP}	Peak pulse power dissipation	10/1000 μs , T_j initial = T_{amb}	600	W
T_{stg}	Storage temperature range		-65 to +175	$^{\circ}\text{C}$
T_j	Operating junction temperature range		-55 to +175	$^{\circ}\text{C}$
T_L	Maximum lead temperature for soldering during 10 s		260	$^{\circ}\text{C}$

Figure 1. Electrical characteristics - parameter definitions



Figure 2. Pulse definition for electrical characteristics



Table 2. Electrical characteristics - parameter values ($T_{amb} = 25\text{ }^{\circ}\text{C}$, unless otherwise specified)

Type	I_{RM} max at V_{RM}			V_{BR} at I_R				10 / 1000 μs			8 / 20 μs			$\alpha T^{(1)(2)}$
								$V_{CL}^{(3)}$	I_{PP}	R_D	$V_{CL}^{(3)}$	I_{PP}	R_D	Max.
	25 $^{\circ}\text{C}$	85 $^{\circ}\text{C}$		Min.	Typ.	Max.		Max.		Max.		Max.	Max.	
	μA	V		V			mA	V	A	Ω	V	A	Ω	$10^{-4}/^{\circ}\text{C}$
SMA6F5.0A	20	50	5.0	6.4	6.74	7.1	10	9.2	68	0.031	13.4	298	0.021	5.7
SMA6F6.0A	20	50	6.0	6.7	7.05	7.4	10	10.3	61	0.048	13.7	290	0.022	5.9
SMA6F6.5A	20	50	6.5	7.2	7.58	8	10	11.2	56	0.057	14.5	276	0.024	6.1
SMA6F8.5A	20	50	8.5	9.4	9.9	10.4	1	14.4	41.7	0.096	19.5	205	0.044	7.3
SMA6F10A	0.2	1	10	11.1	11.7	12.3	1	17	37	0.127	21.7	184	0.051	7.8
SMA6F11A	0.2	1	11	12.3	13	13.7	1	18	33.8	0.127	24.2	165	0.064	8.1
SMA6F12A	0.2	1	12	13.3	14	14.7	1	19.9	31	0.168	25.3	157	0.068	8.3
SMA6F13A	0.2	1	13	14.4	15.2	16	1	21.5	29	0.190	27.2	147	0.076	8.4
SMA6F14A	0.2	1	14	15.7	16.5	17.3	1	23.1	26	0.223	29	136	0.086	8.6
SMA6F15A	0.2	1	15	16.7	17.6	18.5	1	24.4	25.1	0.235	32.5	123	0.114	8.8
SMA6F16A	0.2	1	16	17.9	18.8	19.8	1	26	23.1	0.268	34.7	115	0.130	9.0
SMA6F18A	0.2	1	18	20	21.1	22.2	1	29.2	21.5	0.326	39.3	102	0.168	9.2
SMA6F20A	0.2	1	20	22.2	23.4	24.6	1	32.4	19.4	0.402	42.8	93	0.196	9.4
SMA6F22A	0.2	1	22	24.4	25.7	27	1	35.5	17.7	0.480	48.3	83	0.257	9.6
SMA6F23A	0.2	1	23	25.7	27	28.4	1	37.8	16.4	0.573	49.2	81	0.257	9.6
SMA6F24A	0.2	1	24	26.7	28.1	29.5	1	38.9	16	0.588	50	80	0.256	9.6
SMA6F26A	0.2	1	26	28.9	30.4	31.9	1	42.1	14.9	0.685	53.5	75	0.288	9.7
SMA6F28A	0.2	1	28	31.1	32.7	34.3	1	45.4	13.8	0.804	59	68	0.363	9.8
SMA6F30A	0.2	1	30	33.2	35	36.8	1	48.4	13	0.885	64.3	62	0.442	9.9
SMA6F31A	0.2	1	31	34.2	36	37.8	1	50.2	12.3	1.01	65	61	0.45	9.9
SMA6F33A	0.2	1	33	36.7	38.6	40.5	1	53.3	11.8	1.08	69.7	57	0.512	10
SMA6F36A	0.2	1	36	40	42.1	44.2	1	58.1	10.3	1.35	76	52	0.612	10
SMA6F40A	0.2	1	40	44.4	46.7	49	1	64.5	9.7	1.60	84	48	0.729	10.1
SMA6F48A	0.2	1	48	53.2	56	58.8	1	77.4	8.1	2.28	100	40	1.03	10.3
SMA6F58A	0.2	1	58	64.6	68	71.4	1	93.6	6.7	3.34	121	33	1.51	10.4
SMA6F70A	0.2	1	70	77.9	82	86.1	1	113	5.5	4.91	146	27	2.22	10.5
SMA6F85A	0.2	1	85	95	100	105	1	137	4.6	7.17	178	22.5	3.29	10.6
SMA6F100A	0.2	1	100	111	117	123	1	162	3.8	10.3	212	19	4.68	10.7
SMA6F130A	0.2	1	130	144	152	160	1	209	3	16.3	265	15	7	10.8
SMA6F154A	0.2	1	154	171	180	189	1	246	2.4	23.8	317	12.6	10.2	10.8
SMA6F170A	0.2	1	170	190	200	210	1	275	2.2	30	353	11.3	12.7	10.8
SMA6F188A	0.2	1	188	209	220	231	1	328	2	48.5	388	10.3	15.2	10.8

- To calculate V_{BR} versus T_J : V_{BR} at $T_J = V_{BR}$ at $25\text{ }^{\circ}\text{C} \times (1 + \alpha T \times (T_J - 25))$
- To calculate V_{CL} versus T_J : V_{CL} at $T_J = V_{CL}$ at $25\text{ }^{\circ}\text{C} \times (1 + \alpha T \times (T_J - 25))$
- To calculate V_{CLmax} versus $I_{PPappli}$: $V_{CLmax} = V_{BRmax} + R_D \times I_{PPappli}$

1.1 Characteristics (curves)

Figure 3. Maximum peak power dissipation versus initial junction temperature

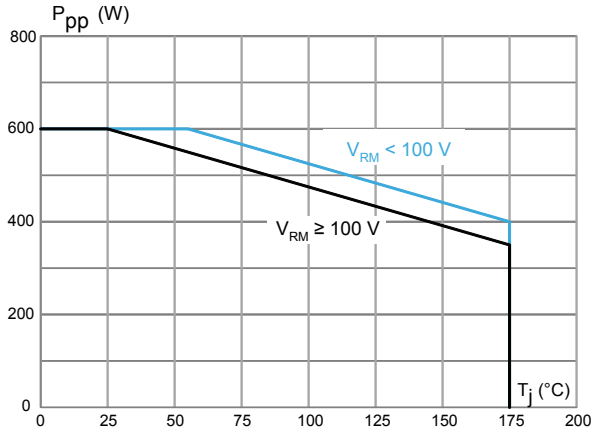

Figure 4. Maximum peak pulse power versus exponential pulse duration

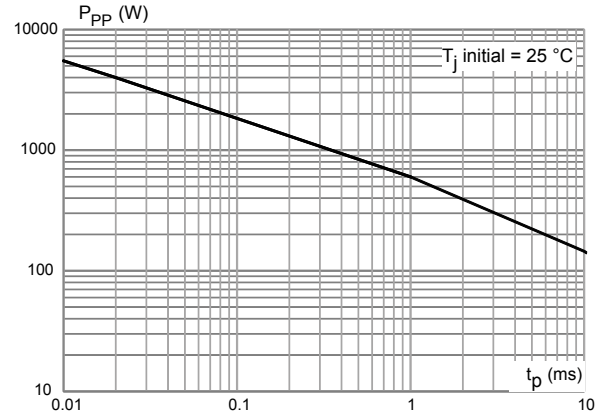

Figure 5. Maximum clamping voltage versus peak pulse current

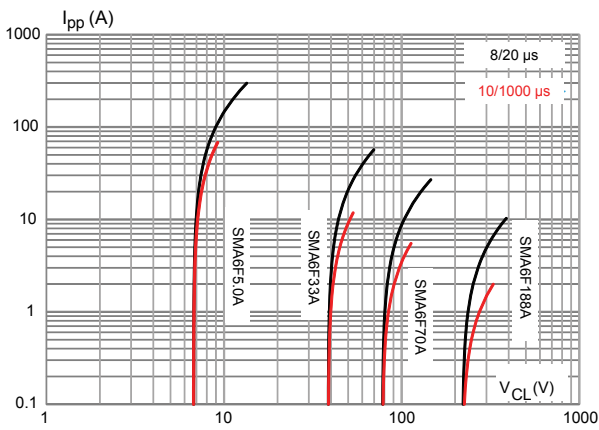

Figure 6. Dynamic resistance versus pulse duration

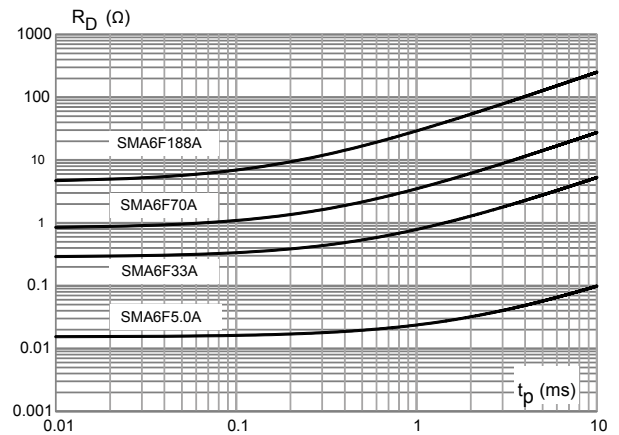

Figure 7. Junction capacitance versus reverse applied voltage

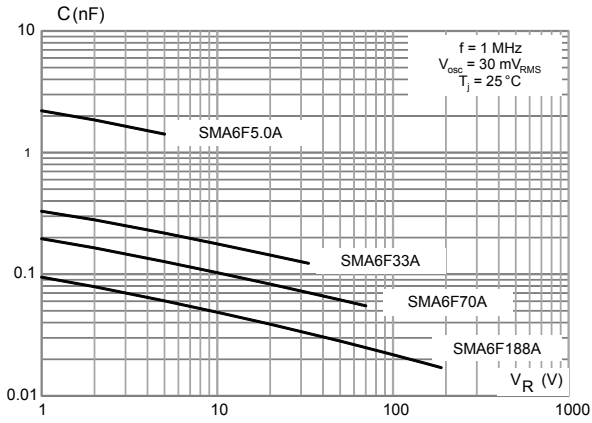

Figure 8. Leakage current versus junction temperature

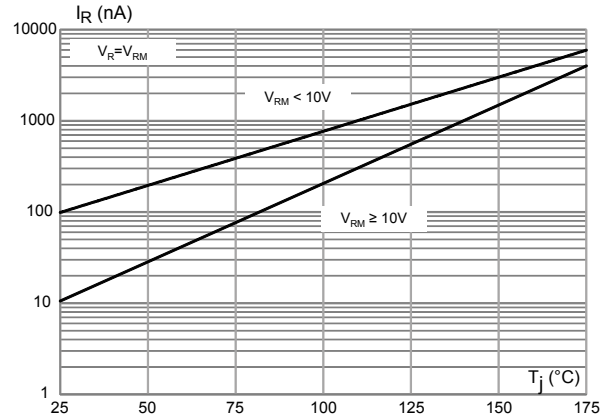

Figure 9. Peak forward voltage drop versus peak forward current

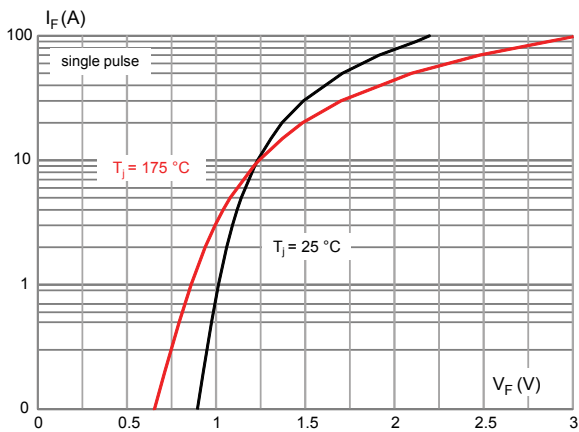

Figure 10. Thermal impedance junction to ambient versus pulse duration

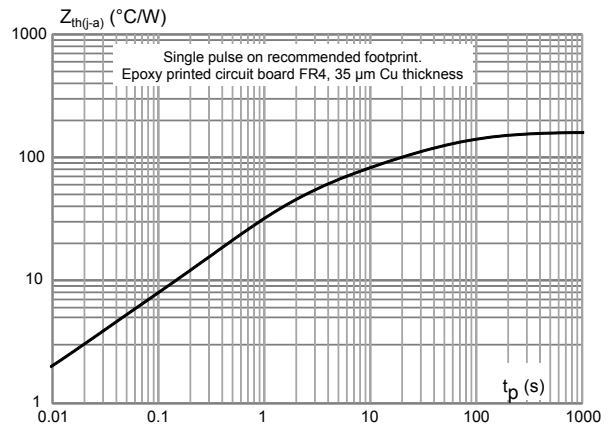
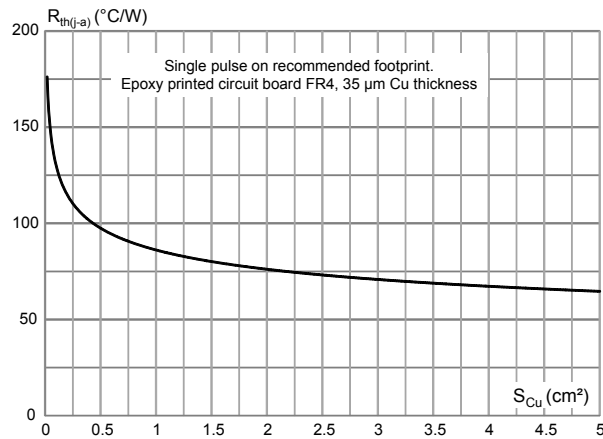

Figure 11. Thermal resistance junction to ambient versus copper area under each lead



2 Package information

In order to meet environmental requirements, ST offers these devices in different grades of ECOPACK® packages, depending on their level of environmental compliance. ECOPACK® specifications, grade definitions and product status are available at: www.st.com. ECOPACK® is an ST trademark.

2.1 SMA Flat package information

Figure 12. SMA Flat package outline

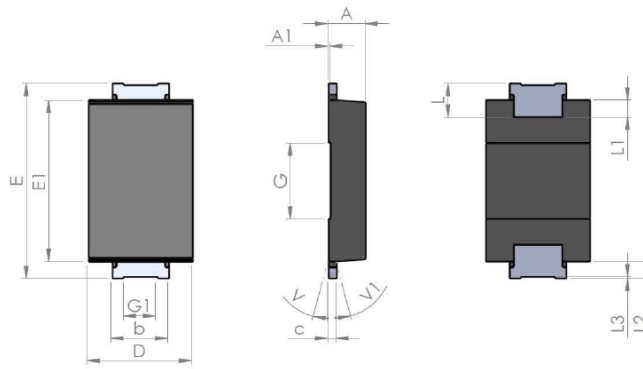

Table 3. SMA Flat mechanical data

Symbol	Millimeters			Inches ⁽¹⁾		
	Min	Typ	Max	Min	Typ	Max
A	0.90		1.10	0.035		0.044
A1		0.05			0.002	
b	1.25		1.65	0.049		0.065
c	0.15		0.40	0.005		0.016
D	2.25		2.90	0.088		0.115
E	5.00		5.35	0.196		0.211
E1	3.95		4.60	0.155		0.182
G		2.00			0.079	
G1		0.85			0.033	
L	0.75		1.20	0.029		0.048
L1		0.45			0.018	
L2		0.45			0.018	
L3		0.05			0.002	
V			8°			8°
V1			8°			8°

1. Values in inches are converted from mm and rounded to 3 decimal digits.

Figure 13. SMA Flat recommended footprint in mm (inches)

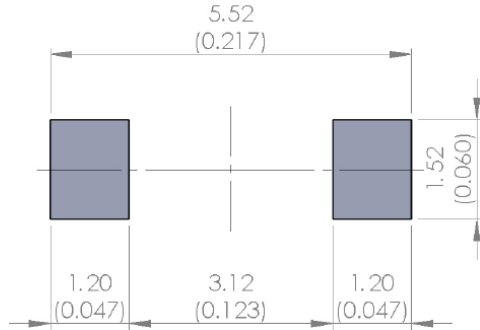

Figure 14. SMA Flat marking

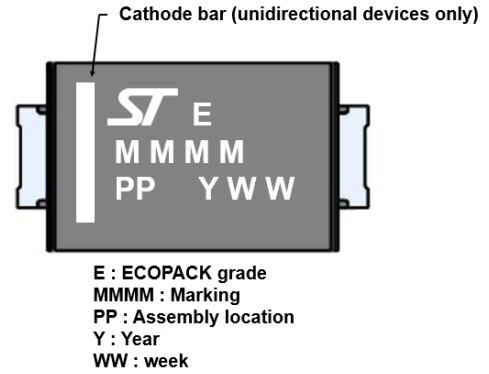
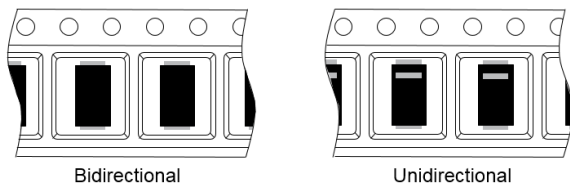

Figure 15. Package orientation in reel



Taped according to EIA-481
Pocket dimensions are not on scale.
Pocket shape may vary depending on package
On bidirectional devices, marking and logo may not be always in the same direction.

Figure 16. Tape and reel orientation

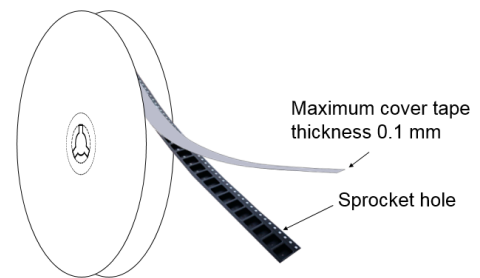

Figure 17. 13" reel dimension values

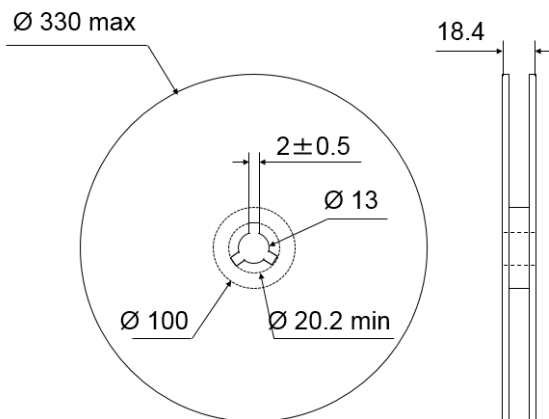

Figure 18. Inner box dimension values

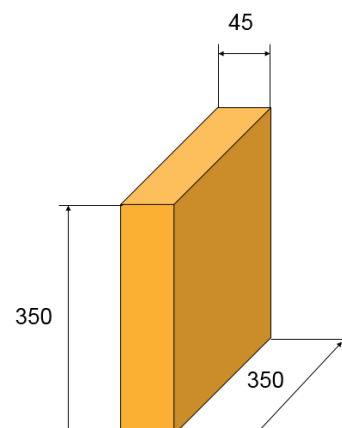
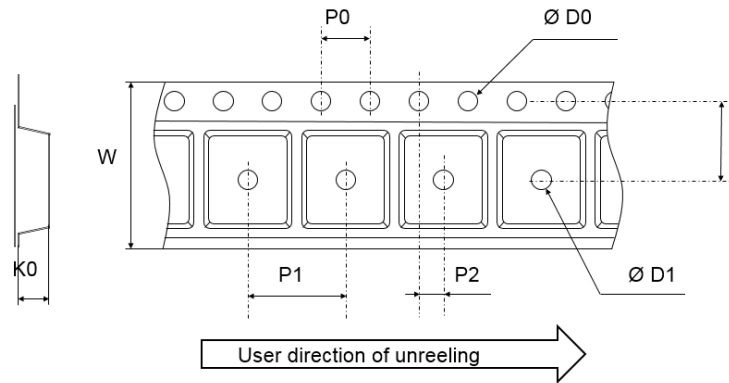

Figure 19. Tape outline



Note: Pocket dimensions are not on scale
Pocket shape may vary depending on package

Table 4. Tape dimension values

Ref.	Dimensions		
	Millimeters		
	Min.	Typ.	Max.
D0	1.5	1.55	1.6
D1	1.5		
F	5.4	5.5	5.6
K0	1.1	1.2	1.3
P0	3.9	4.0	4.1
P1	3.9	4.0	4.1
P2	1.9	2.0	2.1
W	11.7	12	12.3

2.2 Reflow profile

Figure 20. ST ECOPACK® recommended soldering reflow profile for PCB mounting



Note: Minimize air convection currents in the reflow oven to avoid component movement. Maximum soldering profile corresponds to the latest IPC/JEDEC J-STD-020.

3 SMA6FxxA Ordering information

Figure 21. Ordering information scheme

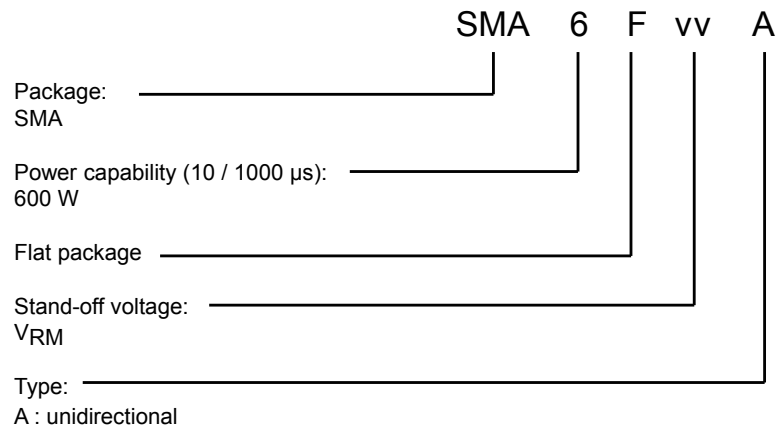

Table 5. Ordering information

Order code	Marking	Package	Weight	Base qty.	Delivery mode
SMA6FxxA	See Table 6. Marking.	SMA Flat	39 mg	10000	Tape and reel

3.1 Marking

Table 6. Marking

Unidirectional	
Order code	Marking
SMA6F5.0A	6AI
SMA6F6.0A	6AK
SMA6F6.5A	6AL
SMA6F8.5A	6AP
SMA6F10A	6AS
SMA6F11A	6AU
SMA6F12A	6AW
SMA6F13A	6AY
SMA6F14A	6BA
SMA6F15A	6BC
SMA6F16A	6BE
SMA6F18A	6BI
SMA6F20A	6BM
SMA6F22A	6BO
SMA6F23A	6BP
SMA6F24A	6BQ
SMA6F26A	6BS
SMA6F28A	6BU
SMA6F30A	6BW
SMA6F31A	6BX
SMA6F33A	6BZ
SMA6F36A	6CC
SMA6F40A	6CG
SMA6F48A	6CO
SMA6F58A	6CY
SMA6F70A	6DK
SMA6F85A	6DZ
SMA6F100A	6EO
SMA6F130A	6FS
SMA6F154A	6GQ
SMA6F170A	6HG
SMA6F188A	6HY

Revision history

Table 7. Document revision history

Date	Version	Changes
18-May-2018	1	Initial release.
09-Jul-2018	2	Corrected typo error in Table 2. Electrical characteristics - parameter values ($T_{amb} = 25\text{ }^{\circ}\text{C}$, unless otherwise specified).
28-Feb-2019	3	Updated links syntax.

IMPORTANT NOTICE – PLEASE READ CAREFULLY

STMicroelectronics NV and its subsidiaries (“ST”) reserve the right to make changes, corrections, enhancements, modifications, and improvements to ST products and/or to this document at any time without notice. Purchasers should obtain the latest relevant information on ST products before placing orders. ST products are sold pursuant to ST’s terms and conditions of sale in place at the time of order acknowledgement.

Purchasers are solely responsible for the choice, selection, and use of ST products and ST assumes no liability for application assistance or the design of Purchasers’ products.

No license, express or implied, to any intellectual property right is granted by ST herein.

Resale of ST products with provisions different from the information set forth herein shall void any warranty granted by ST for such product.



ST and the ST logo are trademarks of ST. All other product or service names are the property of their respective owners.

Information in this document supersedes and replaces information previously supplied in any prior versions of this document.

© 2019 STMicroelectronics – All rights reserved

Looking for pricing, stock, or lifecycle information?

Click below to explore more details on WIN SOURCE:

-  [View SMA6F20A on WIN SOURCE](#)
-  [STMicroelectronics Information](#)

Optimize Your Supply Chain with WIN SOURCE Solutions

-  Global Sourcing Solution
-  Obsolete Management
-  Cost Control Management
-  Shortage Management
-  Alternative Solution
-  Excess Inventory Management