



**THE DATASHEET OF  
SPD2-480-3P0-R**



# Surge Protection Devices

## SPD2 2P+0 SERIES

Class II/Type 2/Type 1 CA Pluggable Multi-Pole

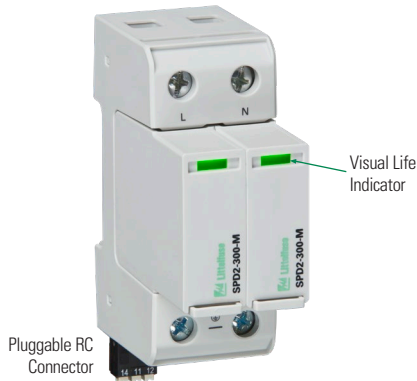

### Description

Surge protection devices (SPDs) provide equipment protection from transient overvoltage events lasting micro-seconds. By limiting the overvoltage to the equipment during these events, costly damage and downtime can be mitigated.

The surge protection devices for the 2+0 configuration are available for 120 V to 600 V nominal voltage sub-distribution board applications.

### Features & Benefits

FEATURES	BENEFITS
<b>Capability to clamp and withstand high-energy transients</b>	Ensures low-residual voltage during high-energy surge events and higher nominal discharge current to prevent disruption, downtime, and degradation or damage to equipment
<b>UL Recognized and VDE-IEC compliant in single part number</b>	One component can be utilized globally, reducing inventory needs and simplifying allocation of parts
<b>Interlocking tab mechanism</b>	Secures module to withstand vibration
<b>No additional overcurrent protection devices required in UL applications</b>	Reduces the number of components and costs required for protection
<b>Compact footprint</b>	Increases panel design flexibility
<b>Visual life indicator</b>	Quick visual determines module replacement status to avoid loss of protection
<b>Pluggable modules</b>	Fast and simple to replace, minimizing maintenance and downtime. No tools required
<b>Thermal protection</b>	Eliminates catastrophic failure
<b>IP20 protection rating</b>	Finger-safe design increases worker protection

### Internal Configuration

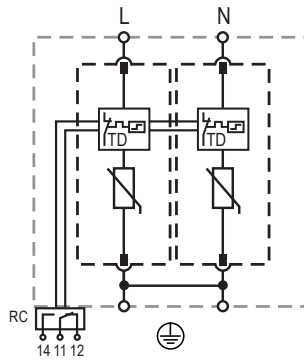

### Legend

- L Line
- N Neutral
- ⊕ Protective Earth
- RC Remote Contacts
- TD Thermal Disconnection

### Module & Base Ordering Information

Ordering Number	IEC Electrical							UL Electrical				Single Unit Weight	
	Nominal AC Voltage (50/60Hz) ( $U_n/U_p$ )	Maximum Continuous Operating AC Voltage ( $U_c$ )	Nominal Discharge Current (8/20 $\mu$ s) ( $I_n$ )	Maximum Discharge Current (8/20 $\mu$ s) ( $I_{max}$ )	Voltage Protection Level ( $U_p$ )	Short-Circuit AC Current Rating ( $I_{SCCR}$ )	TOV Withstand 5 s ( $U_T$ )	TOV 120 min ( $U_T$ ) / Mode	Maximum Continuous AC Operating Voltage (MCOV)	Voltage Protection Rating (VPR)	Nominal Discharge Current (8/20 $\mu$ s) ( $I_n$ )		Short-Circuit Current Rating (SCCR)
SPD2-150-2P0-R	120 V	150 V	20 kA	50 kA	1250 V	25 kA / 50 kA	229 V	229 V / Withstand	150 V	600 V	20 kA	200 kA	252 g (0.556 lb)
SPD2-300-2P0-R	240 V	300 V	20 kA	50 kA	1500 V	25 kA / 50 kA	337 V	442 V / Safe Fail	300 V	900 V	20 kA	150 kA	266 g (0.587 lb)
SPD2-350-2P0-R	277 V	350 V	20 kA	50 kA	1750 V	25 kA / 50 kA	403 V	529 V / Safe Fail	350 V	1000 V	20 kA	200 kA	276 g (0.609 lb)
SPD2-480-2P0-R	400 V	480 V	20 kA	50 kA	2300 V	25 kA / 50 kA	581 V	762 V / Safe Fail	480 V	1500 V	20 kA	200 kA	286 g (0.631 lb)
SPD2-550-2P0-R*	480 V	550 V	20 kA	50 kA	2500 V	25 kA / 50 kA	697 V	915 V / Safe Fail	550 V	2000 V	20 kA	200 kA	290 g (0.639 lb)
SPD2-750-2P0-R	600 V	750 V	20 kA	35 kA	3400 V	25 kA / 50 kA	871 V	1143 V / Safe Fail	750 V	2500 V	20 kA	200 kA	318 g (0.702 lb)

# Surge Protection Devices

## SPD2 2P+0 SERIES

### Module & Base Part Numbering System

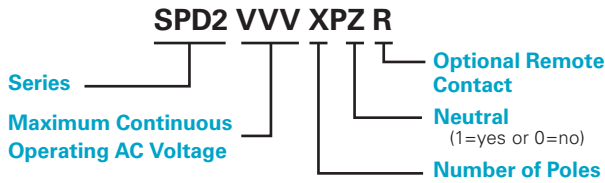

### Module Only Part Numbering System



### Replacement Module Ordering Information

Ordering Number	IEC Electrical							UL Electrical				Single Unit Weight	
	Nominal AC Voltage (50/60Hz) (U <sub>n</sub> / U <sub>c</sub> )	Maximum Continuous Operating AC Voltage (U <sub>c</sub> )	Nominal Discharge Current (8/20 μs) (I <sub>n</sub> )	Maximum Discharge Current (8/20 μs) (I <sub>max</sub> )	Voltage Protection Level (U <sub>p</sub> )	Short-Circuit AC Current Rating (I <sub>SCCR</sub> )	TOV Withstand 5 s (U <sub>1</sub> )	TOV 120 min (U <sub>1</sub> ) / Mode	Maximum Continuous AC Operating Voltage (MCOV)	Voltage Protection Rating (VPR)	Nominal Discharge Current (8/20 μs) (I <sub>n</sub> )		Short-Circuit Current Rating (SCCR)
SPD2-150-M	120 V	150 V	20 kA	50 kA	1250 V	25 kA / 50 kA	229 V	229 V / Withstand	150 V	600 V	20 kA	200 kA	54 g (0.120 lb)
SPD2-300-M	240 V	300 V	20 kA	50 kA	1500 V	25 kA / 50 kA	337 V	442 V / Safe Fail	300 V	900 V	20 kA	150 kA	61 g (0.135 lb)
SPD2-350-M	277 V	350 V	20 kA	50 kA	1750 V	25 kA / 50 kA	403 V	529 V / Safe Fail	350 V	1000 V	20 kA	200 kA	66 g (0.146 lb)
SPD2-480-M	400 V	480 V	20 kA	50 kA	2300 V	25 kA / 50 kA	581 V	762 V / Safe Fail	480 V	1500 V	20 kA	200 kA	71 g (0.157 lb)
SPD2-550-M*	480 V	550 V	20 kA	50 kA	2500 V	25 kA / 50 kA	697 V	915 V / Safe Fail	550 V	2000 V	20 kA	200 kA	74 g (0.163 lb)
SPD2-750-M	600 V	750 V	20 kA	35 kA	3400 V	25 kA / 50 kA	871 V	1143 V / Safe Fail	750 V	2500 V	20 kA	200 kA	87 g (0.192 lb)

### Specifications

<b>Network Systems</b>	IT, TN-S
<b>Mode of Protection</b>	L-PE, N-PE
<b>Nominal Discharge Current (8/20 μs) (I<sub>n</sub>)</b>	20 kA
<b>Maximum Discharge Current (8/20 μs) (I<sub>max</sub>)</b>	Up to 50 kA
<b>Protective Elements</b>	High Energy MOV
<b>Response Time (t<sub>A</sub>)</b>	< 25 ns
<b>Back-Up Fuse (max)</b>	315 A / 250 A Gg
<b>Number of Ports</b>	1
<b>Mechanical &amp; Environmental</b>	
<b>Operating Temperature Range (T<sub>a</sub>)</b>	-40 °C to +80 °C (-40 °F to +185 °F)
<b>Permissible Operating Humidity (RH)</b>	5% to 95%
<b>Altitude (max)</b>	4,000 m (13,123 ft)
<b>Terminal Screw Torque (M<sub>max</sub>)</b>	4.5 Nm (39.9 lbf-in)
<b>Conductor Cross Section (max)</b>	35 mm <sup>2</sup> (2 AWG) (Solid, Stranded) / 25 mm <sup>2</sup> (4 AWG) (Flexible)
<b>Mounting</b>	35 mm DIN Rail, EN60715
<b>Degree of Protection</b>	IP20 (built-in)
<b>Housing Material</b>	Thermoplastic: Extinguishing Degree UL 94 V-0

<b>Thermal Protection</b>	Yes
<b>Operating State/Fault Indication</b>	Green Flag/No Green Flag
<b>Remote Contact Switching Capacity</b>	AC: 250 V/1 A, 125 V/1 A; DC: 48 V/0.5 A, 24 V/0.5 A, 12 V/0.5 A
<b>Remote Contact Conductor Cross Section (max)</b>	1.5 mm <sup>2</sup> (16 AWG) (Solid)
<b>Standards Passed*</b>	IEC 61643-11:2011 EN 61643-11:2012 UL 1449, 4th edition; E320116

<b>Dimensions &amp; Packaging</b>	
<b>2TE Module and Base</b>	<b>H</b> 90.0 mm (3.54"); <b>W</b> 36.0 mm (1.42"); <b>D</b> 70.0 mm (2.76")
<b>1TE Replacement Module</b>	<b>H</b> 45.0 mm (1.77"); <b>W</b> 18.0 mm (0.71"); <b>D</b> 57.2mm (2.25")
<b>Package Dimensions</b>	
<b>2TE Module and Base</b>	<b>H</b> 102.0 mm (4.01"); <b>W</b> 46.0 mm (1.81"); <b>D</b> 110.0 mm (4.33")
<b>1TE Replacement Module</b>	<b>H</b> 102.0 mm (4.01"); <b>W</b> 28.0 mm (1.10"); <b>D</b> 110.0 mm (4.33")

\*SPD2-550-2P0-R and SPD2-550-M are UL Listed only

Warranty – Visit [www.littelfuse.com/warranty](http://www.littelfuse.com/warranty) for details.

Disclaimer Notice – Information furnished is believed to be accurate and reliable. However, users should independently evaluate the suitability of and test each product selected for their own applications. Littelfuse products are not designed for, and may not be used in, all applications. Read complete Disclaimer Notice at [www.littelfuse.com/product-disclaimer](http://www.littelfuse.com/product-disclaimer).

## Looking for pricing, stock, or lifecycle information?

Click below to explore more details on WIN SOURCE:

 [View SPD2-480-3P0-R on WIN SOURCE](#)

 [Littelfuse Inc. Information](#)

## Optimize Your Supply Chain with WIN SOURCE Solutions

-  Global Sourcing Solution
-  Obsolete Management
-  Cost Control Management
-  Shortage Management
-  Alternative Solution
-  Excess Inventory Management