



**THE DATASHEET OF  
XF3M-5015-1B**



# XF3M

For FPC/FFC

Rotary Backlock Connector (0.5-mm Pitch, 1.0-mm Pitch, Dual sided, Upper sided Contact)

## Rotary Backlock Connectors Provide Improved Insertion of FPC/FFC Cables and helps Confirm Proper Connection with Sure Lock Feel.

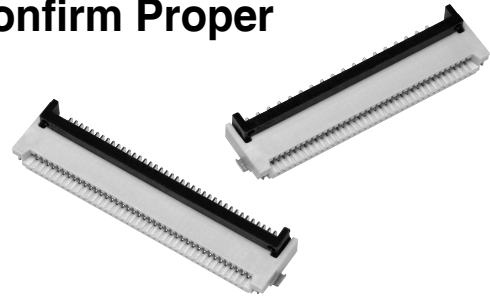

- Models available with 0.5-mm or 1.0-mm pitch.
- Models available with dual-sided contacts or upper sided. (Models with upper sided come only with a 0.5-mm pitch.)
- Models available with gold or Tin-plated. (Tin-plated is available only with models with dual-sided contacts.)
- Models with 80 pins (multiple type) available with 0.5-mm pitch.
- Applicable FPC/FFC thickness of 0.3 mm.
- Halogen Free (\*)

\* OMRON uses the following standard to determine halogen-free construction: 900 ppm max. for Br, 900 ppm max. for Cl, and 1,500 ppm max. for Br+Cl.

RoHS compliant

### ■ Ratings and Specifications

|                               |  |
|-------------------------------|--|
| Rated current                 | 0.5 A AC/DC                                      |
| Rated voltage                 | 50 V AC/DC                                       |
| Contact resistance            | 50 mΩ max. (at 20 mV DC max., 100 mA max.)       |
| Insulation resistance         | 100 MΩ min. (at 250 V DC)                        |
| Dielectric strength           | 250 V AC for 1 min. (leakage current: 1 mA max.) |
| Insertion durability          | Gold-plated: 20 times<br>Tin-plated: 10 times    |
| Ambient operating temperature | -30 to 85 °C (With no icing or condensation)     |

### ■ Materials and Finish

| Model     | Dual-sided Contact Models                     |                            | Upper sided Models           |
|-----------|---|----------------------------|------------------------------|
|           | Gold-plated                                   | Tin-plated                 | Gold-plated                  |
| Housing   | LCP resin (UL94 V-0)/natural                  |                            | LCP resin (UL94 V-0)/gray    |
| Slider    | LCP resin (UL94 V-0)/black                    |                            |                              |
| Contacts  | Spring copper alloy/nickel substrate (1.5 μm) |                            |                              |
|           | Gold-plated contacts (flash)                  | Tin-plated contacts (1 μm) | Gold-plated contacts (flash) |
| Hold-down | Copper alloy/tin-plated (1 μm)                |                            |                              |

### ■ Models

| Contact type<br>Pitch | Dual-sided contact  |                 | Upper sided         |              |
|-----------------------|---------------------|-----------------|---------------------|--------------|
|                       | Contacts            | Model           | Contacts            | Model        |
| 0.5 mm                | Gold-plated (flash) | XF3M-□□15-1B□   | Gold-plated (flash) | XF3M-□□25-1B |
|                       | Tin-plated          | XF3M-□□15-1D    |                     |              |
| 1.0 mm                | Gold-plated (flash) | XF3M(1)-□□15-1B |                     |              |
|                       | Tin-plated          | XF3M(1)-□□15-1D |                     |              |

XF3M

# XF3M Rotary Backlock Connector (0.5-mm Pitch, 1.0-mm Pitch, Dual sided, Upper sided Contact)

## XF3M 0.5-mm pitch model

### ■ Dimensions

(Unit: mm)

XF3M-□□15-1B  
 XF3M-□□15-1BE  
 XF3M-□□15-1D  
 XF3M-□□25-1B

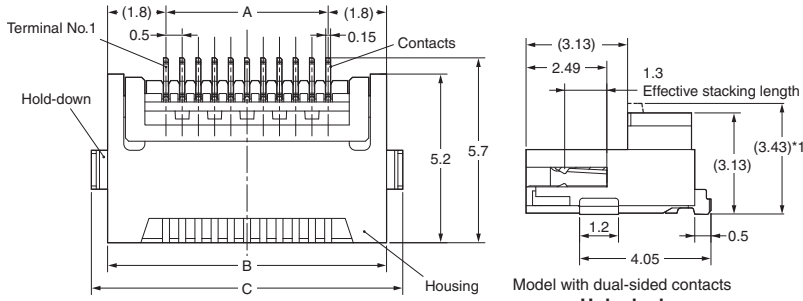
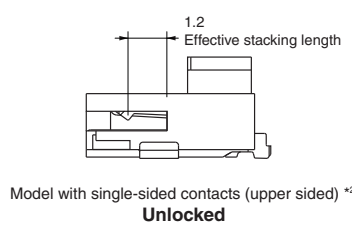
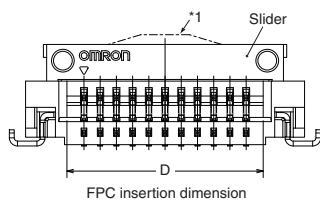
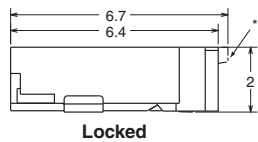

Table of Dimension

| Pins <sup>*1</sup> | A    | B    | C    | D     | E    | F    | G    |
|--------------------|------|------|------|-------|------|------|------|
| 4                  | 1.5  | 5.1  | 6.1  | 2.55  | 2.5  | 3.5  | 7.1  |
| 5                  | 2.0  | 5.6  | 6.6  | 3.05  | 3.0  | 4.0  | 7.6  |
| 6                  | 2.5  | 6.1  | 7.1  | 3.55  | 3.5  | 4.5  | 8.1  |
| 7                  | 3.0  | 6.6  | 7.6  | 4.05  | 4.0  | 5.0  | 8.6  |
| 8                  | 3.5  | 7.1  | 8.1  | 4.55  | 4.5  | 5.5  | 9.1  |
| 9                  | 4.0  | 7.6  | 8.6  | 5.05  | 5.0  | 6.0  | 9.6  |
| 10                 | 4.5  | 8.1  | 9.1  | 5.55  | 5.5  | 6.5  | 10.1 |
| 11                 | 5.0  | 8.6  | 9.6  | 6.05  | 6.0  | 7.0  | 10.6 |
| 12                 | 5.5  | 9.1  | 10.1 | 6.55  | 6.5  | 7.5  | 11.1 |
| 13                 | 6.0  | 9.6  | 10.6 | 7.05  | 7.0  | 8.0  | 11.6 |
| 14                 | 6.5  | 10.1 | 11.1 | 7.55  | 7.5  | 8.5  | 12.1 |
| 15                 | 7.0  | 10.6 | 11.6 | 8.05  | 8.0  | 9.0  | 12.6 |
| 16                 | 7.5  | 11.1 | 12.1 | 8.55  | 8.5  | 9.5  | 13.1 |
| 17                 | 8.0  | 11.6 | 12.6 | 9.05  | 9.0  | 10.0 | 13.6 |
| 18                 | 8.5  | 12.1 | 13.1 | 9.55  | 9.5  | 10.5 | 14.1 |
| 19                 | 9.0  | 12.6 | 13.6 | 10.05 | 10.0 | 11.0 | 14.6 |
| 20                 | 9.5  | 13.1 | 14.1 | 10.55 | 10.5 | 11.5 | 15.1 |
| 21                 | 10.0 | 13.6 | 14.6 | 11.05 | 11.0 | 12.0 | 15.6 |
| 22                 | 10.5 | 14.1 | 15.1 | 11.55 | 11.5 | 12.5 | 16.1 |
| 23                 | 11.0 | 14.6 | 15.6 | 12.05 | 12.0 | 13.0 | 16.6 |
| 24                 | 11.5 | 15.1 | 16.1 | 12.55 | 12.5 | 13.5 | 17.1 |
| 25                 | 12.0 | 15.6 | 16.6 | 13.05 | 13.0 | 14.0 | 17.6 |
| 26                 | 12.5 | 16.1 | 17.1 | 13.55 | 13.5 | 14.5 | 18.1 |
| 28                 | 13.5 | 17.1 | 18.1 | 14.55 | 14.5 | 15.5 | 19.1 |
| 29                 | 14.0 | 17.6 | 18.6 | 15.05 | 15.0 | 16.0 | 19.6 |
| 30                 | 14.5 | 18.1 | 19.1 | 15.55 | 15.5 | 16.5 | 20.1 |
| 31                 | 15.0 | 18.6 | 19.6 | 16.05 | 16.0 | 17.0 | 20.6 |
| 32                 | 15.5 | 19.1 | 20.1 | 16.55 | 16.5 | 17.5 | 21.1 |
| 33                 | 16.0 | 19.6 | 20.6 | 17.05 | 17.0 | 18.0 | 21.6 |
| 34                 | 16.5 | 20.1 | 21.1 | 17.55 | 17.5 | 18.5 | 22.1 |
| 35                 | 17.0 | 20.6 | 21.6 | 18.05 | 18.0 | 19.0 | 22.6 |
| 36                 | 17.5 | 21.1 | 22.1 | 18.55 | 18.5 | 19.5 | 23.1 |
| 37                 | 18.0 | 21.6 | 22.6 | 19.05 | 19.0 | 20.0 | 23.6 |
| 38                 | 18.5 | 22.1 | 23.1 | 19.55 | 19.5 | 20.5 | 24.1 |
| 40                 | 19.5 | 23.1 | 24.1 | 20.55 | 20.5 | 21.5 | 25.1 |
| 41                 | 20.0 | 23.6 | 24.6 | 21.05 | 21.0 | 22.0 | 25.6 |
| 42                 | 20.5 | 24.1 | 25.1 | 21.55 | 21.5 | 22.5 | 26.1 |
| 45                 | 22.0 | 25.6 | 26.6 | 23.05 | 23.0 | 24.0 | 27.6 |
| 50                 | 24.5 | 28.1 | 29.1 | 25.55 | 25.5 | 26.5 | 30.1 |
| 51                 | 25.0 | 28.6 | 29.6 | 26.05 | 26.0 | 27.0 | 30.6 |
| 53                 | 26.0 | 29.6 | 30.6 | 27.05 | 27.0 | 28.0 | 31.6 |
| 54                 | 26.5 | 30.1 | 31.1 | 27.55 | 27.5 | 28.5 | 32.1 |
| 55                 | 27.0 | 30.6 | 31.6 | 28.05 | 28.0 | 29.0 | 32.6 |
| 57                 | 28.0 | 31.6 | 32.6 | 29.05 | 29.0 | 30.0 | 33.6 |
| 60                 | 29.5 | 33.1 | 34.1 | 30.55 | 30.5 | 31.5 | 35.1 |
| 80                 | 39.5 | 43.1 | 44.1 | 40.55 | 40.5 | 41.5 | 45.1 |



Model with single-sided contacts (upper sided) \*2



Locked

PCB Dimensions (TOP VIEW)

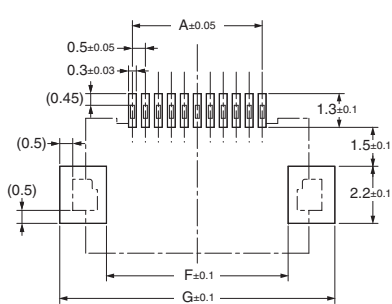

Recommended FPC/FFC Dimensions

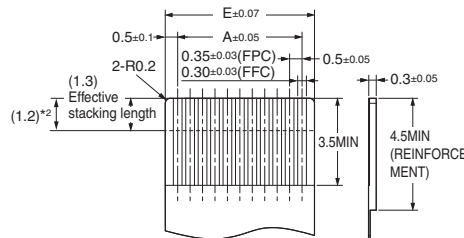

\*1. Dotted lines indicate the shape and dimensions of the XF3M-8015-1BE Connectors.

\*2. For the XF3M-□□25-1B Connectors.

### ■ Ordering Information

#### ● Dual-sided Contact Models - Gold-plated (flash)

1500pcs per reel

| Pins <sup>*1</sup> | Model        | Pins <sup>*1</sup> | Model        | Pins <sup>*1</sup> | Model        | Pins <sup>*1</sup> | Model        | Quantity per reel (unit) <sup>*2</sup> |
|--------------------|--------------|--------------------|--------------|--------------------|--------------|--------------------|--------------|--|
| 4                  | XF3M-0415-1B | 16                 | XF3M-1615-1B | 29                 | XF3M-2915-1B | 42                 | XF3M-4215-1B | 1,500                                  |
| 5                  | XF3M-0515-1B | 17                 | XF3M-1715-1B | 30                 | XF3M-3015-1B | 45                 | XF3M-4515-1B |  |
| 6                  | XF3M-0615-1B | 18                 | XF3M-1815-1B | 31                 | XF3M-3115-1B | 50                 | XF3M-5015-1B |  |
| 7                  | XF3M-0715-1B | 19                 | XF3M-1915-1B | 32                 | XF3M-3215-1B | 51                 | XF3M-5115-1B |  |
| 8                  | XF3M-0815-1B | 20                 | XF3M-2015-1B | 33                 | XF3M-3315-1B | 53                 | XF3M-5315-1B |  |
| 9                  | XF3M-0915-1B | 21                 | XF3M-2115-1B | 34                 | XF3M-3415-1B | 54                 | XF3M-5415-1B |  |
| 10                 | XF3M-1015-1B | 22                 | XF3M-2215-1B | 35                 | XF3M-3515-1B | 55                 | XF3M-5515-1B |  |
| 11                 | XF3M-1115-1B | 23                 | XF3M-2315-1B | 36                 | XF3M-3615-1B | 57                 | XF3M-5715-1B |  |
| 12                 | XF3M-1215-1B | 24                 | XF3M-2415-1B | 37                 | XF3M-3715-1B | 60                 | XF3M-6015-1B |  |
| 13                 | XF3M-1315-1B | 25                 | XF3M-2515-1B | 38                 | XF3M-3815-1B |                    |              |  |
| 14                 | XF3M-1415-1B | 26                 | XF3M-2615-1B | 40                 | XF3M-4015-1B |                    |              |  |
| 15                 | XF3M-1515-1B | 28                 | XF3M-2815-1B | 41                 | XF3M-4115-1B |                    |              |  |

1000pcs per reel

| Pins <sup>*1</sup> | Model         | Quantity per reel (unit) <sup>*2</sup> |
|--------------------|---------------|--|
| 80                 | XF3M-8015-1BE | 1,000                                  |

XF3M

# XF3M Rotary Backlock Connector (0.5-mm Pitch, 1.0-mm Pitch, Dual sided, Upper sided Contact)

100pcs per reel

| Pins <sup>*1</sup> | Model             | Pins <sup>*1</sup> | Model             | Pins <sup>*1</sup> | Model             | Pins <sup>*1</sup> | Model              | Quantity per reel (unit) <sup>*2</sup> |
|--------------------|-------------------|--------------------|-------------------|--------------------|-------------------|--------------------|--------------------|--|
| 4                  | XF3M-0415-1B-R100 | 16                 | XF3M-1615-1B-R100 | 29                 | XF3M-2915-1B-R100 | 42                 | XF3M-4215-1B-R100  | 100                                    |
| 5                  | XF3M-0515-1B-R100 | 17                 | XF3M-1715-1B-R100 | 30                 | XF3M-3015-1B-R100 | 45                 | XF3M-4515-1B-R100  |  |
| 6                  | XF3M-0615-1B-R100 | 18                 | XF3M-1815-1B-R100 | 31                 | XF3M-3115-1B-R100 | 50                 | XF3M-5015-1B-R100  |  |
| 7                  | XF3M-0715-1B-R100 | 19                 | XF3M-1915-1B-R100 | 32                 | XF3M-3215-1B-R100 | 51                 | XF3M-5115-1B-R100  |  |
| 8                  | XF3M-0815-1B-R100 | 20                 | XF3M-2015-1B-R100 | 33                 | XF3M-3315-1B-R100 | 53                 | XF3M-5315-1B-R100  |  |
| 9                  | XF3M-0915-1B-R100 | 21                 | XF3M-2115-1B-R100 | 34                 | XF3M-3415-1B-R100 | 54                 | XF3M-5415-1B-R100  |  |
| 10                 | XF3M-1015-1B-R100 | 22                 | XF3M-2215-1B-R100 | 35                 | XF3M-3515-1B-R100 | 55                 | XF3M-5515-1B-R100  |  |
| 11                 | XF3M-1115-1B-R100 | 23                 | XF3M-2315-1B-R100 | 36                 | XF3M-3615-1B-R100 | 57                 | XF3M-5715-1B-R100  |  |
| 12                 | XF3M-1215-1B-R100 | 24                 | XF3M-2415-1B-R100 | 37                 | XF3M-3715-1B-R100 | 60                 | XF3M-6015-1B-R100  |  |
| 13                 | XF3M-1315-1B-R100 | 25                 | XF3M-2515-1B-R100 | 38                 | XF3M-3815-1B-R100 | 80                 | XF3M-8015-1BE-R100 |  |
| 14                 | XF3M-1415-1B-R100 | 26                 | XF3M-2615-1B-R100 | 40                 | XF3M-4015-1B-R100 |                    |                    |  |
| 15                 | XF3M-1515-1B-R100 | 28                 | XF3M-2815-1B-R100 | 41                 | XF3M-4115-1B-R100 |                    |                    |  |

● Dual-sided Contact Models - Tin-plated

1500pcs per reel

| Pins <sup>*1</sup> | Model        | Pins <sup>*1</sup> | Model        | Pins <sup>*1</sup> | Model        | Pins <sup>*1</sup> | Model        | Quantity per reel (unit) <sup>*2</sup> |
|--------------------|--------------|--------------------|--------------|--------------------|--------------|--------------------|--------------|--|
| (4)                | XF3M-0415-1D | (14)               | XF3M-1415-1D | (24)               | XF3M-2415-1D | (35)               | XF3M-3515-1D | 1,500                                  |
| (5)                | XF3M-0515-1D | (15)               | XF3M-1515-1D | (25)               | XF3M-2515-1D | (36)               | XF3M-3615-1D |  |
| (6)                | XF3M-0615-1D | (16)               | XF3M-1615-1D | (26)               | XF3M-2615-1D | (37)               | XF3M-3715-1D |  |
| (7)                | XF3M-0715-1D | (17)               | XF3M-1715-1D | (28)               | XF3M-2815-1D | (38)               | XF3M-3815-1D |  |
| (8)                | XF3M-0815-1D | (18)               | XF3M-1815-1D | (29)               | XF3M-2915-1D | (40)               | XF3M-4015-1D |  |
| (9)                | XF3M-0915-1D | (19)               | XF3M-1915-1D | (30)               | XF3M-3015-1D | (41)               | XF3M-4115-1D |  |
| 10                 | XF3M-1015-1D | (20)               | XF3M-2015-1D | (31)               | XF3M-3115-1D | (42)               | XF3M-4215-1D |  |
| (11)               | XF3M-1115-1D | (21)               | XF3M-2115-1D | (32)               | XF3M-3215-1D | (45)               | XF3M-4515-1D |  |
| (12)               | XF3M-1215-1D | (22)               | XF3M-2215-1D | (33)               | XF3M-3315-1D | (50)               | XF3M-5015-1D |  |
| (13)               | XF3M-1315-1D | (23)               | XF3M-2315-1D | (34)               | XF3M-3415-1D |                    |              |  |

100pcs per reel

| Pins <sup>*1</sup> | Model             | Pins <sup>*1</sup> | Model             | Pins <sup>*1</sup> | Model             | Pins <sup>*1</sup> | Model             | Quantity per reel (unit) <sup>*2</sup> |
|--------------------|-------------------|--------------------|-------------------|--------------------|-------------------|--------------------|-------------------|--|
| (4)                | XF3M-0415-1D-R100 | (14)               | XF3M-1415-1D-R100 | (24)               | XF3M-2415-1D-R100 | (35)               | XF3M-3515-1D-R100 | 100                                    |
| (5)                | XF3M-0515-1D-R100 | (15)               | XF3M-1515-1D-R100 | (25)               | XF3M-2515-1D-R100 | (36)               | XF3M-3615-1D-R100 |  |
| (6)                | XF3M-0615-1D-R100 | (16)               | XF3M-1615-1D-R100 | (26)               | XF3M-2615-1D-R100 | (37)               | XF3M-3715-1D-R100 |  |
| (7)                | XF3M-0715-1D-R100 | (17)               | XF3M-1715-1D-R100 | (28)               | XF3M-2815-1D-R100 | (38)               | XF3M-3815-1D-R100 |  |
| (8)                | XF3M-0815-1D-R100 | (18)               | XF3M-1815-1D-R100 | (29)               | XF3M-2915-1D-R100 | (40)               | XF3M-4015-1D-R100 |  |
| (9)                | XF3M-0915-1D-R100 | (19)               | XF3M-1915-1D-R100 | (30)               | XF3M-3015-1D-R100 | (41)               | XF3M-4115-1D-R100 |  |
| 10                 | XF3M-1015-1D-R100 | (20)               | XF3M-2015-1D-R100 | (31)               | XF3M-3115-1D-R100 | (42)               | XF3M-4215-1D-R100 |  |
| (11)               | XF3M-1115-1D-R100 | (21)               | XF3M-2115-1D-R100 | (32)               | XF3M-3215-1D-R100 | (45)               | XF3M-4515-1D-R100 |  |
| (12)               | XF3M-1215-1D-R100 | (22)               | XF3M-2215-1D-R100 | (33)               | XF3M-3315-1D-R100 | (50)               | XF3M-5015-1D-R100 |  |
| (13)               | XF3M-1315-1D-R100 | (23)               | XF3M-2315-1D-R100 | (34)               | XF3M-3415-1D-R100 |                    |                   |  |

● Upper-sided Models - Gold-plated (flash)

1500pcs per reel

| Pins <sup>*1</sup> | Model        | Pins <sup>*1</sup> | Model        | Pins <sup>*1</sup> | Model        | Pins <sup>*1</sup> | Model        | Quantity per reel (unit) <sup>*2</sup> |
|--------------------|--------------|--------------------|--------------|--------------------|--------------|--------------------|--------------|--|
| (4)                | XF3M-0425-1B | 13                 | XF3M-1325-1B | 22                 | XF3M-2225-1B | (32)               | XF3M-3225-1B | 1,500                                  |
| (5)                | XF3M-0525-1B | 14                 | XF3M-1425-1B | (23)               | XF3M-2325-1B | (33)               | XF3M-3325-1B |  |
| (6)                | XF3M-0625-1B | (15)               | XF3M-1525-1B | 24                 | XF3M-2425-1B | (34)               | XF3M-3425-1B |  |
| 7                  | XF3M-0725-1B | 16                 | XF3M-1625-1B | (25)               | XF3M-2525-1B | (35)               | XF3M-3525-1B |  |
| 8                  | XF3M-0825-1B | (17)               | XF3M-1725-1B | 26                 | XF3M-2625-1B | (36)               | XF3M-3625-1B |  |
| 9                  | XF3M-0925-1B | 18                 | XF3M-1825-1B | (28)               | XF3M-2825-1B | (37)               | XF3M-3725-1B |  |
| 10                 | XF3M-1025-1B | (19)               | XF3M-1925-1B | (29)               | XF3M-2925-1B | (38)               | XF3M-3825-1B |  |
| (11)               | XF3M-1125-1B | 20                 | XF3M-2025-1B | (30)               | XF3M-3025-1B | 40                 | XF3M-4025-1B |  |
| 12                 | XF3M-1225-1B | (21)               | XF3M-2125-1B | (31)               | XF3M-3125-1B |                    |              |  |

100pcs per reel

| Pins <sup>*1</sup> | Model             | Pins <sup>*1</sup> | Model             | Pins <sup>*1</sup> | Model             | Pins <sup>*1</sup> | Model             | Quantity per reel (unit) <sup>*2</sup> |
|--------------------|-------------------|--------------------|-------------------|--------------------|-------------------|--------------------|-------------------|--|
| (4)                | XF3M-0425-1B-R100 | (13)               | XF3M-1325-1B-R100 | (22)               | XF3M-2225-1B-R100 | (32)               | XF3M-3225-1B-R100 | 100                                    |
| (5)                | XF3M-0525-1B-R100 | (14)               | XF3M-1425-1B-R100 | (23)               | XF3M-2325-1B-R100 | (33)               | XF3M-3325-1B-R100 |  |
| (6)                | XF3M-0625-1B-R100 | (15)               | XF3M-1525-1B-R100 | (24)               | XF3M-2425-1B-R100 | (34)               | XF3M-3425-1B-R100 |  |
| (7)                | XF3M-0725-1B-R100 | (16)               | XF3M-1625-1B-R100 | (25)               | XF3M-2525-1B-R100 | (35)               | XF3M-3525-1B-R100 |  |
| (8)                | XF3M-0825-1B-R100 | (17)               | XF3M-1725-1B-R100 | (26)               | XF3M-2625-1B-R100 | (36)               | XF3M-3625-1B-R100 |  |
| (9)                | XF3M-0925-1B-R100 | 18                 | XF3M-1825-1B-R100 | (28)               | XF3M-2825-1B-R100 | (37)               | XF3M-3725-1B-R100 |  |
| (10)               | XF3M-1025-1B-R100 | (19)               | XF3M-1925-1B-R100 | (29)               | XF3M-2925-1B-R100 | (38)               | XF3M-3825-1B-R100 |  |
| (11)               | XF3M-1125-1B-R100 | (20)               | XF3M-2025-1B-R100 | (30)               | XF3M-3025-1B-R100 | (40)               | XF3M-4025-1B-R100 |  |
| (12)               | XF3M-1225-1B-R100 | (21)               | XF3M-2125-1B-R100 | (31)               | XF3M-3125-1B-R100 |                    |                   |  |

\*1. Please consult your OMRON representative for available pin count.  
Please consult your OMRON representative for the marketing dates for pin counts in parentheses.  
\*2. Please order by integer multiple of the quantity per reel.

# XF3M Rotary Backlock Connector (0.5-mm Pitch, 1.0-mm Pitch, Dual sided, Upper sided Contact)

## XF3M(1) 1.0-mm pitch model

### ■ Dimensions

(Unit: mm)

XF3M(1)-□□15-1B  
XF3M(1)-□□15-1D

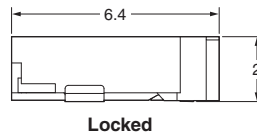
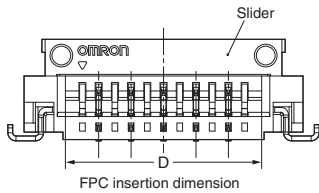
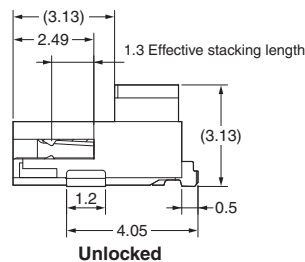
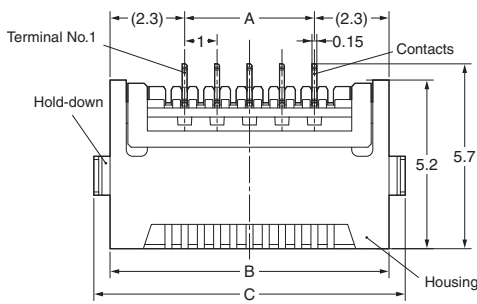

PCB Dimensions (TOP VIEW)

Recommended FPC/FFC Dimensions

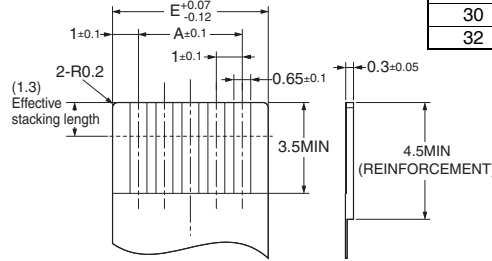
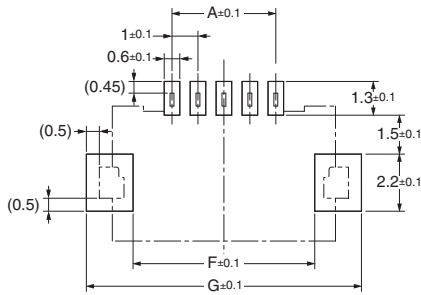

Table of Dimensions

| Pins*1 | A    | B    | C    | D     | E    | F    | G    |
|--------|------|------|------|-------|------|------|------|
| 4      | 3.0  | 7.6  | 8.6  | 5.05  | 5.0  | 6.0  | 9.6  |
| 5      | 4.0  | 8.6  | 9.6  | 6.05  | 6.0  | 7.0  | 10.6 |
| 6      | 5.0  | 9.6  | 10.6 | 7.05  | 7.0  | 8.0  | 11.6 |
| 7      | 6.0  | 10.6 | 11.6 | 8.05  | 8.0  | 9.0  | 12.6 |
| 8      | 7.0  | 11.6 | 12.6 | 9.05  | 9.0  | 10.0 | 13.6 |
| 9      | 8.0  | 12.6 | 13.6 | 10.05 | 10.0 | 11.0 | 14.6 |
| 10     | 9.0  | 13.6 | 14.6 | 11.05 | 11.0 | 12.0 | 15.6 |
| 11     | 10.0 | 14.6 | 15.6 | 12.05 | 12.0 | 13.0 | 16.6 |
| 12     | 11.0 | 15.6 | 16.6 | 13.05 | 13.0 | 14.0 | 17.6 |
| 14     | 13.0 | 17.6 | 18.6 | 15.05 | 15.0 | 16.0 | 19.6 |
| 15     | 14.0 | 18.6 | 19.6 | 16.05 | 16.0 | 17.0 | 20.6 |
| 16     | 15.0 | 19.6 | 20.6 | 17.05 | 17.0 | 18.0 | 21.6 |
| 17     | 16.0 | 20.6 | 21.6 | 18.05 | 18.0 | 19.0 | 22.6 |
| 18     | 17.0 | 21.6 | 22.6 | 19.05 | 19.0 | 20.0 | 23.6 |
| 20     | 19.0 | 23.6 | 24.6 | 21.05 | 21.0 | 22.0 | 25.6 |
| 22     | 21.0 | 25.6 | 26.6 | 23.05 | 23.0 | 24.0 | 27.6 |
| 23     | 22.0 | 26.6 | 27.6 | 24.05 | 24.0 | 25.0 | 28.6 |
| 24     | 23.0 | 27.6 | 28.6 | 25.05 | 25.0 | 26.0 | 29.6 |
| 25     | 24.0 | 28.6 | 29.6 | 26.05 | 26.0 | 27.0 | 30.6 |
| 26     | 25.0 | 29.6 | 30.6 | 27.05 | 27.0 | 28.0 | 31.6 |
| 28     | 27.0 | 31.6 | 32.6 | 29.05 | 29.0 | 30.0 | 33.6 |
| 30     | 29.0 | 33.6 | 34.6 | 31.05 | 31.0 | 32.0 | 35.6 |
| 32     | 31.0 | 35.6 | 36.6 | 33.05 | 33.0 | 34.0 | 37.6 |

### ■ Ordering Information

#### ● Dual-sided Contact Models - Gold-plated (flash)

1500pcs per reel

| Pins*1 | Model           | Pins*1 | Model           | Pins*1 | Model           | Pins*1 | Model           | Quantity per reel (unit) *2 |
|--------|-----------------|--------|-----------------|--------|-----------------|--------|-----------------|-----------------------------|
| 4      | XF3M(1)-0415-1B | 10     | XF3M(1)-1015-1B | (17)   | XF3M(1)-1715-1B | 25     | XF3M(1)-2515-1B | 1,500                       |
| 5      | XF3M(1)-0515-1B | 11     | XF3M(1)-1115-1B | 18     | XF3M(1)-1815-1B | 26     | XF3M(1)-2615-1B |                             |
| 6      | XF3M(1)-0615-1B | 12     | XF3M(1)-1215-1B | 20     | XF3M(1)-2015-1B | 28     | XF3M(1)-2815-1B |                             |
| 7      | XF3M(1)-0715-1B | 14     | XF3M(1)-1415-1B | 22     | XF3M(1)-2215-1B | 30     | XF3M(1)-3015-1B |                             |
| 8      | XF3M(1)-0815-1B | 15     | XF3M(1)-1515-1B | 23     | XF3M(1)-2315-1B | 32     | XF3M(1)-3215-1B |                             |
| 9      | XF3M(1)-0915-1B | 16     | XF3M(1)-1615-1B | (24)   | XF3M(1)-2415-1B |        |                 |                             |

100pcs per reel

| Pins*1 | Model                | Pins*1 | Model                | Pins*1 | Model                | Pins*1 | Model                | Quantity per reel (unit) *2 |
|--------|----------------------|--------|----------------------|--------|----------------------|--------|----------------------|-----------------------------|
| 4      | XF3M(1)-0415-1B-R100 | 10     | XF3M(1)-1015-1B-R100 | (17)   | XF3M(1)-1715-1B-R100 | (25)   | XF3M(1)-2515-1B-R100 | 100                         |
| 5      | XF3M(1)-0515-1B-R100 | 11     | XF3M(1)-1115-1B-R100 | 18     | XF3M(1)-1815-1B-R100 | 26     | XF3M(1)-2615-1B-R100 |                             |
| 6      | XF3M(1)-0615-1B-R100 | 12     | XF3M(1)-1215-1B-R100 | 20     | XF3M(1)-2015-1B-R100 | (28)   | XF3M(1)-2815-1B-R100 |                             |
| 7      | XF3M(1)-0715-1B-R100 | 14     | XF3M(1)-1415-1B-R100 | 22     | XF3M(1)-2215-1B-R100 | 30     | XF3M(1)-3015-1B-R100 |                             |
| 8      | XF3M(1)-0815-1B-R100 | 15     | XF3M(1)-1515-1B-R100 | 23     | XF3M(1)-2315-1B-R100 | (32)   | XF3M(1)-3215-1B-R100 |                             |
| 9      | XF3M(1)-0915-1B-R100 | 16     | XF3M(1)-1615-1B-R100 | (24)   | XF3M(1)-2415-1B-R100 |        |                      |                             |

#### ● Dual-sided Contact Models - Tin-plated

1500pcs per reel

| Pins*1 | Model           | Pins*1 | Model           | Pins*1 | Model           | Pins*1 | Model           | Quantity per reel (unit) *2 |
|--------|-----------------|--------|-----------------|--------|-----------------|--------|-----------------|-----------------------------|
| (4)    | XF3M(1)-0415-1D | 10     | XF3M(1)-1015-1D | (17)   | XF3M(1)-1715-1D | (25)   | XF3M(1)-2515-1D | 1,500                       |
| (5)    | XF3M(1)-0515-1D | (11)   | XF3M(1)-1115-1D | 18     | XF3M(1)-1815-1D | (26)   | XF3M(1)-2615-1D |                             |
| (6)    | XF3M(1)-0615-1D | 12     | XF3M(1)-1215-1D | 20     | XF3M(1)-2015-1D | (28)   | XF3M(1)-2815-1D |                             |
| (7)    | XF3M(1)-0715-1D | (14)   | XF3M(1)-1415-1D | 22     | XF3M(1)-2215-1D | (30)   | XF3M(1)-3015-1D |                             |
| (8)    | XF3M(1)-0815-1D | (15)   | XF3M(1)-1515-1D | (23)   | XF3M(1)-2315-1D | (32)   | XF3M(1)-3215-1D |                             |
| (9)    | XF3M(1)-0915-1D | (16)   | XF3M(1)-1615-1D | (24)   | XF3M(1)-2415-1D |        |                 |                             |

100pcs per reel

| Pins*1 | Model                | Pins*1 | Model                | Pins*1 | Model                | Pins*1 | Model                | Quantity per reel (unit) *2 |
|--------|----------------------|--------|----------------------|--------|----------------------|--------|----------------------|-----------------------------|
| (4)    | XF3M(1)-0415-1D-R100 | 10     | XF3M(1)-1015-1D-R100 | (17)   | XF3M(1)-1715-1D-R100 | (25)   | XF3M(1)-2515-1D-R100 | 100                         |
| (5)    | XF3M(1)-0515-1D-R100 | (11)   | XF3M(1)-1115-1D-R100 | (18)   | XF3M(1)-1815-1D-R100 | (26)   | XF3M(1)-2615-1D-R100 |                             |
| (6)    | XF3M(1)-0615-1D-R100 | (12)   | XF3M(1)-1215-1D-R100 | (20)   | XF3M(1)-2015-1D-R100 | (28)   | XF3M(1)-2815-1D-R100 |                             |
| (7)    | XF3M(1)-0715-1D-R100 | (14)   | XF3M(1)-1415-1D-R100 | (22)   | XF3M(1)-2215-1D-R100 | (30)   | XF3M(1)-3015-1D-R100 |                             |
| (8)    | XF3M(1)-0815-1D-R100 | (15)   | XF3M(1)-1515-1D-R100 | (23)   | XF3M(1)-2315-1D-R100 | (32)   | XF3M(1)-3215-1D-R100 |                             |
| (9)    | XF3M(1)-0915-1D-R100 | (16)   | XF3M(1)-1615-1D-R100 | (24)   | XF3M(1)-2415-1D-R100 |        |                      |                             |

\*1. Please consult your OMRON representative for available pin count.  
Please consult your OMRON representative for the marketing dates for pin counts in parentheses.  
\*2. Please order by integer multiple of the quantity per reel.

## Looking for pricing, stock, or lifecycle information?

Click below to explore more details on WIN SOURCE:

- [View XF3M-5015-1B on WIN SOURCE](#)
- [Omron Information](#)

## Optimize Your Supply Chain with WIN SOURCE Solutions

- ✓ Global Sourcing Solution
- ✓ Obsolete Management
- ✓ Cost Control Management
- ✓ Shortage Management
- ✓ Alternative Solution
- ✓ Excess Inventory Management