

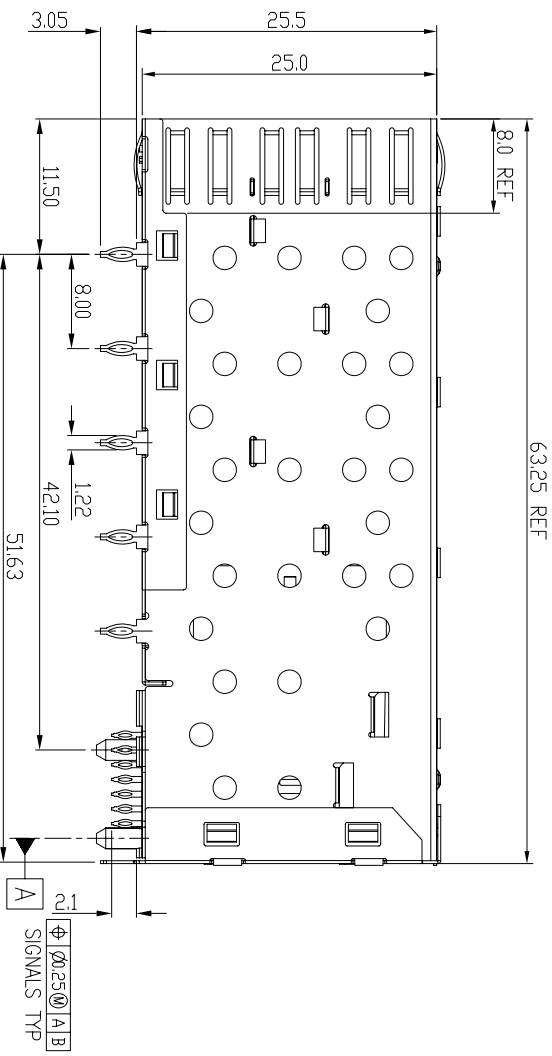

THE DATASHEET OF SFP0-3047-L





DETACHED LISTS

	MM	(DINCH)	
TOLEANCES EXCEPT AS NOTED			
MM			
	0 ± 0.25		±
	.00 ± 0.20		±
	.000 ± 0.10		±
ANGLES ± 0.5			

RoHS Compliant

TITLE
SFP 2 BY 1 CAGE+CONNECTOR_S

DFTD YICAN
DATE 4/19/10

THIRD ANGLE PROJECTION
SCALE : 2:1



Pulse
A TECHNICAL COMPANY

w/O LIGHT PIPES

DRAWING NO: CSFP0-3047-L
/PART NO: SFP0-3047-L

DDI NDT SCALE DRAWING

SIZE: A3
REV: 4

PLATING
NICKEL
GILD

6 5 4 3 2 1

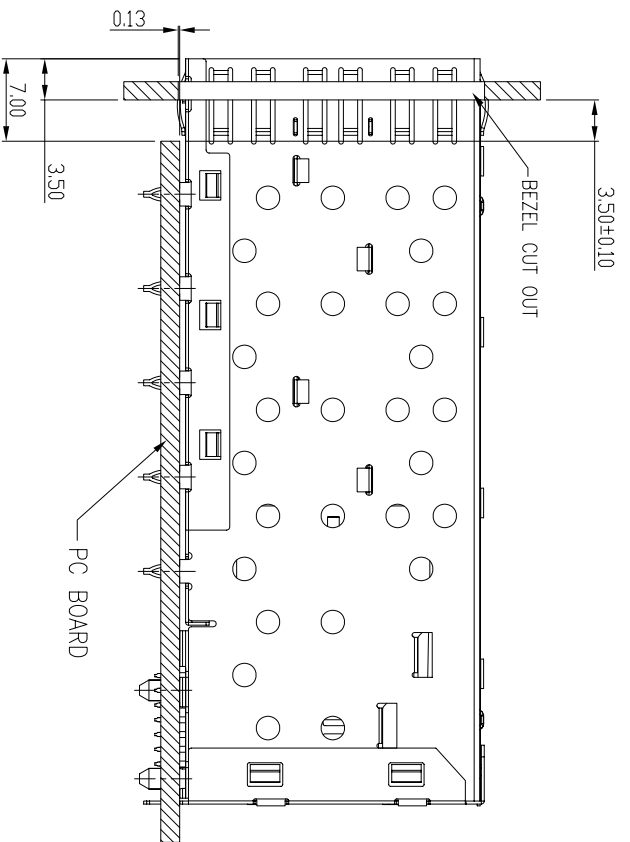

AGING DETAIL

DETACHED LISTS		MM		(INCH)	
TOLERANCES EXCEPT AS NOTED					
MM					
0 ± 0.25		±		±	
.00 ± 0.20		±		±	
.000 ± 0.10		±		±	
ANGLES ± 0.5					
THIRD ANGLE PROJECTION					
DPTD YICGN		RoHS Compliant			
DATE 4/19/10		 Pulse <small>A TECHNICAL COMPANY</small>			
SCALE : 2:1		TITLE			
DDI NDT SCALE DRAWING		SFP 2 BY 1 CAGE+CONNECTOR_S			
DRAWING NO CSFP0-3047-L		W/O LIGHT PIPES			
/PART NO SFP0-3047-L		SIZE			
SHEET 2		A3			
OF 3		REV			
		4			

6 5 4 3 2 1

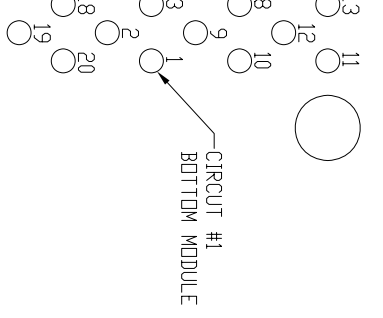
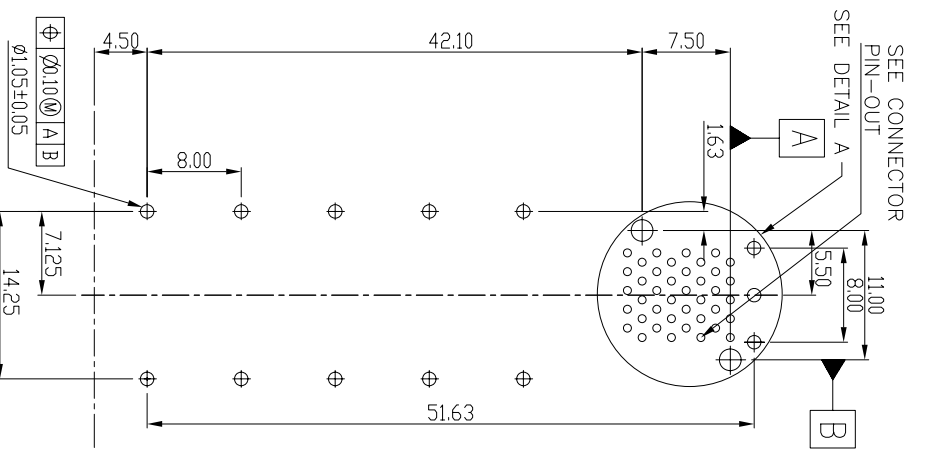
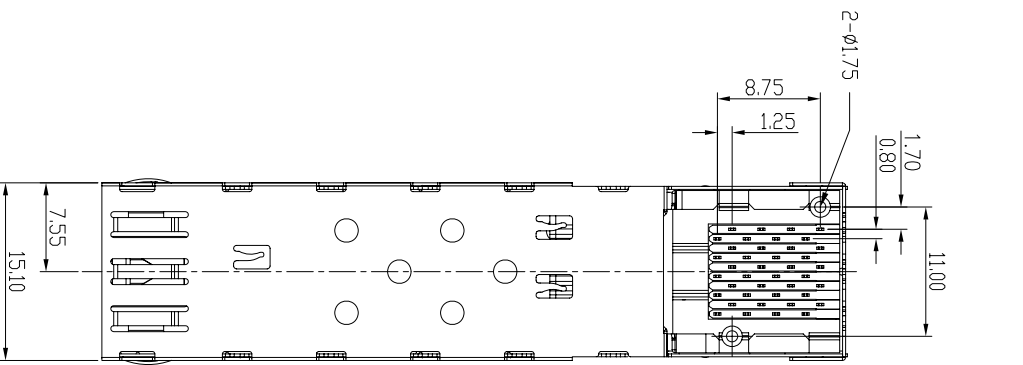
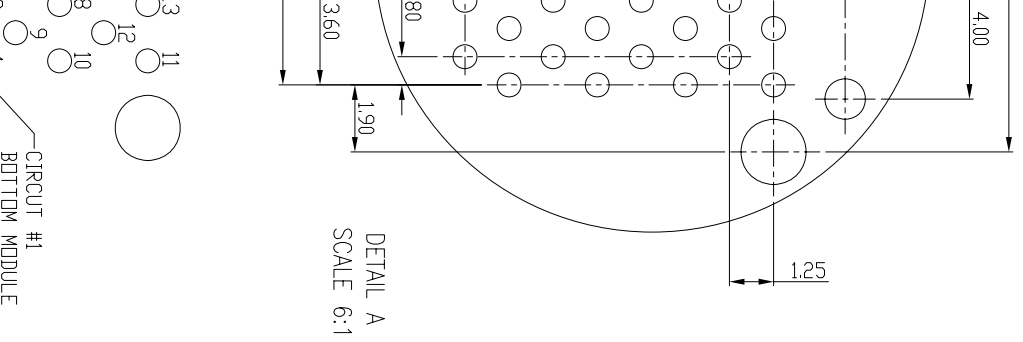

IN-OUT
OF BOARD

6 5 4 3 2 1

DETACHED LISTS

MM	(INCH)
0 ± 0.25	±
.00 ± 0.20	±
.000 ± 0.10	±
ANGLES ± 0.5	

TOLERANCES EXCEPT AS NOTED

THIRD ANGLE PROJECTION

RoHS Compliant





TITLE		SFP 2 BY 1 CAGE+CONNECTOR_S	
DRG YICAN	DRAWING NO. CSFP0-3047-L	DATE 4/19/10	/PART NO. SFP0-3047-L
W/O LIGHT PIPES		DD NOT SCALE DRAWING	SHEET 3 OF 3

A B C D E F G H

Looking for pricing, stock, or lifecycle information?

Click below to explore more details on WIN SOURCE:

-  [View SFP0-3047-L on WIN SOURCE](#)
-  [Pulse Information](#)

Optimize Your Supply Chain with WIN SOURCE Solutions

-  Global Sourcing Solution
-  Obsolete Management
-  Cost Control Management
-  Shortage Management
-  Alternative Solution
-  Excess Inventory Management