



**THE DATASHEET OF
SSQ-116-22-S-S**



THROUGH-HOLE .025" SQ POST SOCKET

(2.54 mm) .100" PITCH • SSW/SSQ SERIES



SSW/SSQ

Mates:

TSW, MTSW, MTLW,
DW, EW, ZW, TSS, ZSS,
TSM, TSSH, HTSS

SPECIFICATIONS

Insulator Material:

Black Liquid Crystal Polymer (-S & -D) or
Black High Temperature Thermoplastic (-T)

Contact Material:

Phosphor Bronze

Plating:

Au or Sn over

50 μ" (1.27 μm) Ni

Current Rating (SSW/TSM):

4.7 A per pin

(2 pins powered)

Current Rating (SSQ/TSW):

6.3 A per pin

(2 pins powered)

Operating Temp Range:

-55 °C to +125 °C with Gold

-55 °C to +105 °C with Tin

Insertion Depth:

(3.68 mm) .145" to

(6.35 mm) .250"

Max Cycles:

100 with 10 μ" (0.25 μm) Au

Voltage Rating:

465 VAC / 655 VDC

PROCESSING

Lead-Free Solderable:

Yes:

-S and -D row option

No, Lead Wave only:

-P, -T and -Q row option

SERIES	1	NO. PINS PER ROW	LEAD STYLE	PLATING OPTION	ROW OPTION	TAIL OPTION	OTHER OPTION
--------	---	------------------	------------	----------------	------------	-------------	--------------

SSW
= Solder Tail

01 thru 50

Specify
LEAD STYLE
from chart

-F
= Gold flash on contact,
Matte Tin on tail

-S
= Single Row

Leave blank for straight pin version)

-LL
= Locking Lead

Available on tails from

(2.29 mm)

.090" to

(7.87 mm)

.310" only.

Not Available with single

row 1 or 2 positions)

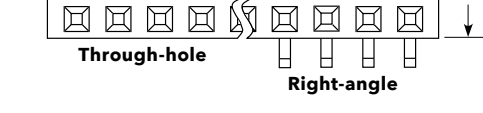
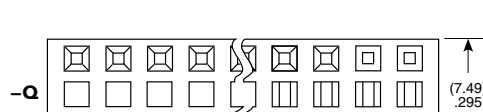
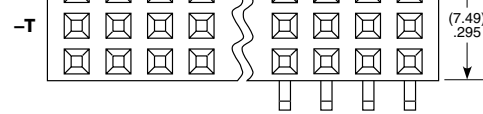
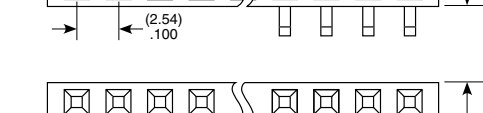
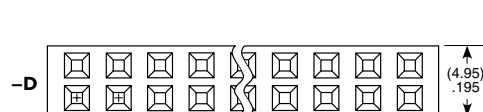
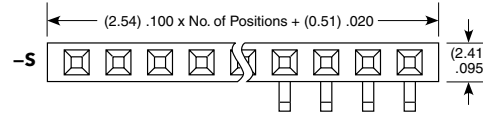

-L
= 10 μ" (0.25 μm)
Gold on contact,
Matte Tin on tail

-P
= Single Row
(36 pins max)

-RA
= Right-angle

THROUGH-HOLE		
LEAD STYLE		SINGLE DOUBLE OR TRIPLE A
Standard Insertion Force	Low Insertion Force*	
-01	-21	(2.64) .104
-02	-22	(4.93) .194
-03	-23	(10.00) .394
-04	-24	(14.83) .584
-06**	N/A	(3.15) .124

* LIF not available with Tin Plating
**Style -06 Not available with SSQ

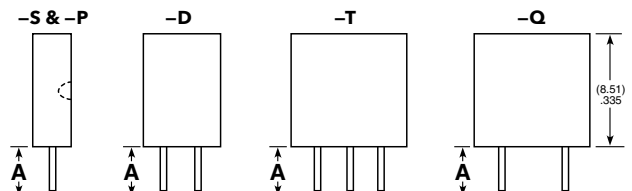

Straight Pin Versions

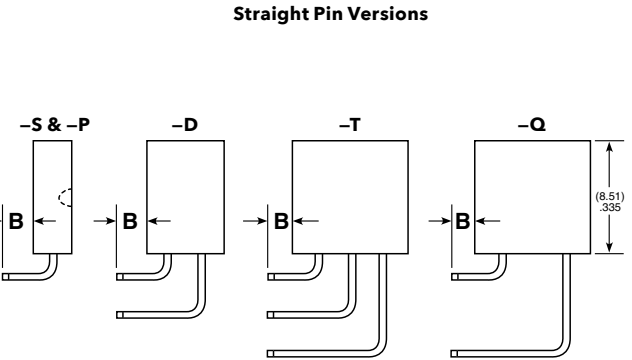

Right-angle Versions

RIGHT-ANGLE				
LEAD STYLE		SINGLE	DOUBLE	TRIPLE
Standard Insertion Force	Low Insertion Force*	(-S) B	(-D) B	(-T & -Q) B
-02	-22	(2.54) .100	(2.54) .100	(2.54) .100
-03	-23	(7.62) .300	(7.62) .300	N/A
-04	-24	(12.45) .490	N/A	N/A

*LIF not available with Tin Plating

Note:
Some lengths, styles and options are non-standard, non-returnable.

Looking for pricing, stock, or lifecycle information?

Click below to explore more details on WIN SOURCE:

 [View SSQ-116-22-S-S on WIN SOURCE](#)

 [Samtec Inc. Information](#)

Optimize Your Supply Chain with WIN SOURCE Solutions

-  Global Sourcing Solution
-  Obsolete Management
-  Cost Control Management
-  Shortage Management
-  Alternative Solution
-  Excess Inventory Management