



**THE DATASHEET OF
SI5XX5X7-EVB**



EVALUATION BOARD FOR Si53x/55x/59x XO's/VCXOs

Description

This document describes the operation of the Skyworks Si5xx5x7-EVB evaluation board to evaluate both Skyworks' Si55x and Si595 VCXOs and Si53x and Si590/591 XO's. The Si53x/55x/59x devices use Skyworks' advanced DSPLL® circuitry to provide a low-jitter clock at high frequencies. The Si55x/Si53x/59x IC-based device is factory configurable for a wide variety of user specifications including frequency, supply voltage, output, and tuning slope. Specific configurations are factory programmed into the Si55x/Si53x/59x at time of shipment, thereby eliminating the long lead times associated with custom oscillators. Si55x/Si53x/59x samples should be ordered at the same time as the Si5xx5x7-EVB since the EVB does not come with the device. This allows end users maximum flexibility. Skyworks can solder down samples when ordering an EVB; please specify when ordering.

Features

- Evaluation of Skyworks' Si55x/53x/59x family
- AC-coupled differential output clocks
- Voltage control (V_C) input port (for Si55x/595 devices)
- Jumper selection for multi-frequency outputs
- Jumper selection for output enable

Functional Block Diagram

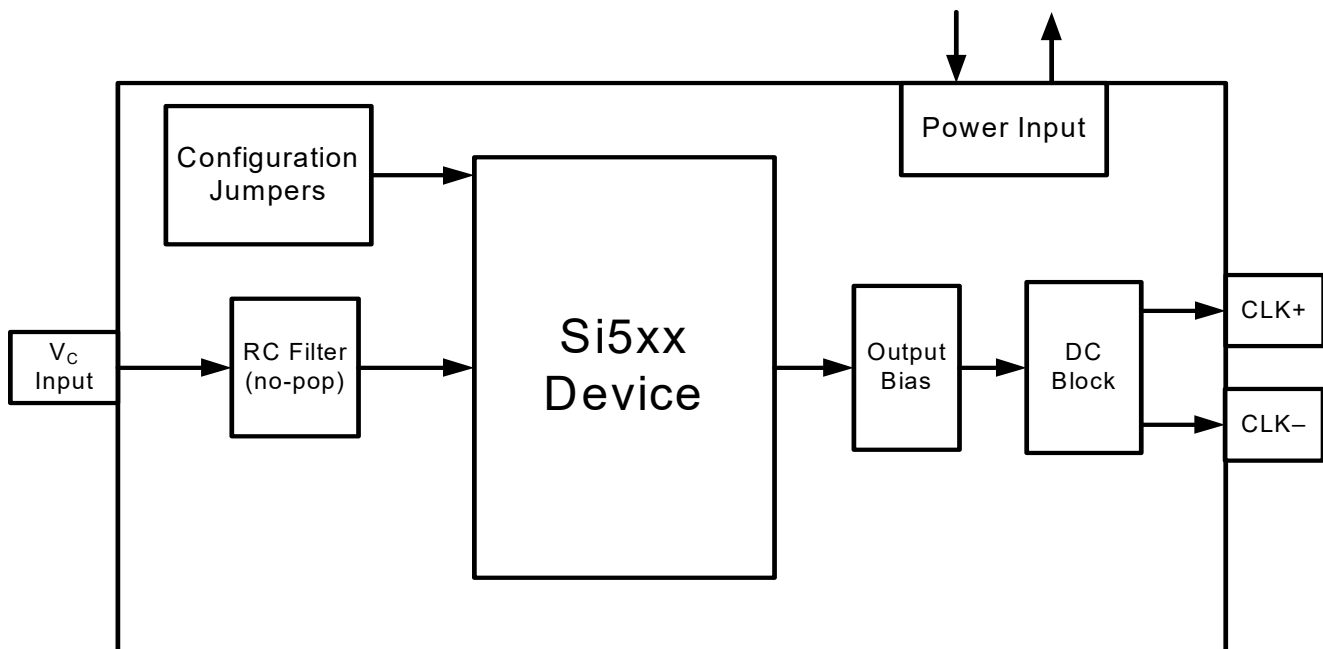

Si5xx5x7-EVB

1. Functional Description

The Si5xx5x7-EVB provides access to all signals for configuring and operating the device. This board allows evaluation of the Si55x/595 VCXO device either by itself (open-loop) or within a prototype PLL (closed-loop). The performance of the Si53x/590/591 XO device can also be evaluated on this board (the V_C port is not used for XO devices).

Table 1. Jumper Control

Part Type	JP1	JP2	JP3	JP4
Si530	N/A	N/A	OE	N/A
Si531	N/A	N/A	N/A	OE
Si532	N/A	N/A	OE	Freq Sel
Si533	N/A	N/A	Freq Sel	OE
Si534	Freq Sel1	Freq Sel2	OE	N/A
Si550	N/A	N/A	OE	V _C
Si552	N/A	N/A	Freq Sel	V _C
Si554	Freq Sel1	Freq Sel2	OE	V _C
Si590	N/A	N/A	OE	N/A
Si591	N/A	N/A	N/A	OE
Si595	N/A	N/A	OE	V _C

Notes:

1. With jumper(s) installed, signal(s) are driven low.
2. With jumper(s) not installed, signal(s) are pulled high.

1.1. Power Supply

The Si55x/Si53x/59x devices support operation from nominal voltages of 1.8, 2.5, and 3.3 V. Review the device data sheet and part number for allowed configurations of output buffer type and device power supply.

1.2. Voltage Control for VCXOs

The voltage control (V_C) input of the Si55x/595 device is conveniently accessible through an SMA jack (J3) but can also be driven (and observed) through 100 mil-centered posts (JP4). For prototyping purposes, two 0603 solder pads are located near the device V_C input (R3 and C3). A traditional PLL might use these as a single-time-constant low-pass filter (RC filter). The EVB is shipped with a 0 Ω resistor soldered at R3; C3 is left open. The voltage control input is not used for XO devices.

1.3. Output Clock

Because the Si55x/Si53x/59x devices can support an LVPECL buffer type (in addition to LVDS and CMOS), pulldown resistors (R1 and R2) are available for proper output biasing. For LVPECL buffers, biasing can be achieved through a variety of equivalent circuits; the Si5xx5x7-EVB allows for 130 Ω pulldown resistors. After the output biasing, the high-speed outputs are dc-blocked for connection to differently biased inputs, such as standard test equipment or a phase detector EVB. Please review “1.4. Preparing the EVB” for non-LVPECL devices.

1.4. Preparing the EVB

By default, the evaluation board is set up to accept LVPECL configured devices. This configuration uses 130 Ω pull-down resistors to bias the LVPECL output stage. If an LVDS, CMOS, or CML based device is to be installed, the output biasing resistors, R1 and R2, should be removed.

2. Schematics

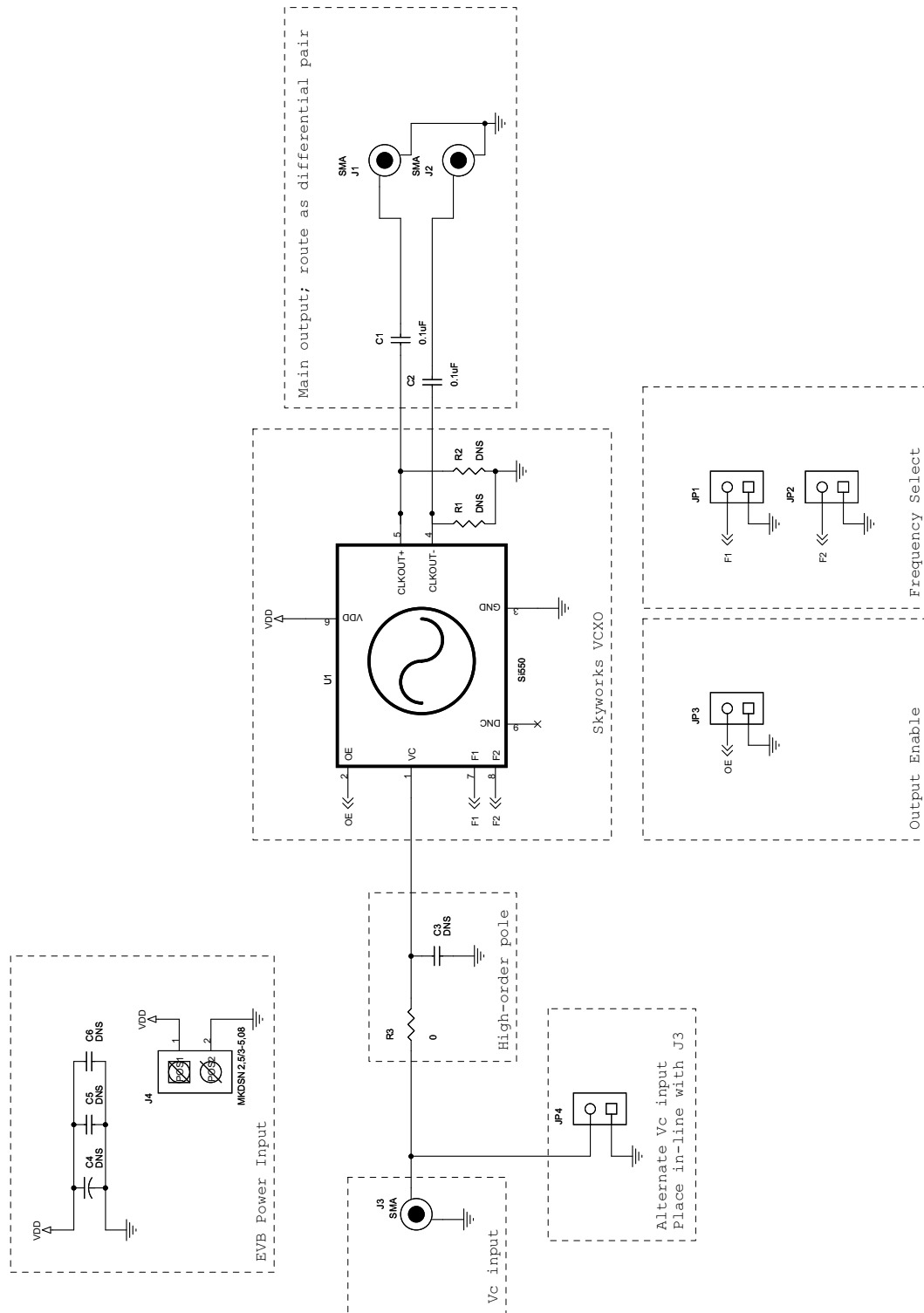

Figure 1. Si5xx5x7-EVB Schematic

Si5xx5x7-EVB

3. Bill of Materials

Table 2. Si5xx5x7-EVB Bill of Materials

Item	Qty	Ref	Description	Mfr #	Mfr
1	2	C1,C2	CAP,SM,0.1 μ F, 16 V,20%,X7R,0402	C0402X7R160-104KNE	Venkel
2	2	C5	CAP,SM,0.1 μ F, 16 V,20%,X7R,0603	C0603X7R160-104KNE	Venkel
3	1	C4	CAP,SM,10 μ F, 10 V,10%,TANTALUM,3216	TA010TCM106KAR	Venkel
4	1	C6	CAP,SM,100 pF, 50 V,10%,COG,0603	C0603C0G500-101KNE	Venkel
5	4	JP1,JP2, JP3,JP4	CONN,HEADER,2X1	TSW-150-07-T-D or TSW-150-07-T-S	Samtec
6	3	J1,J2,J3	CONN,SMA SIDE MOUNT	901-10003	Amphenol
7	1	J4	CONN,POWER, 2 POSITION	1729018	Phoenix Contact
8	1	R3	RES,SM,0 Ω ,0603	CR0603-16W-000T	Venkel
9	2	R1,R2	RES,SM,150,1%,0603	CR0603-16W-1500FT	Venkel
No Load					
11	1	C3	CAP,SM,0.1 μ F, 16 V,20%,X7R,0603	C0603X7R160-104KNE	Venkel
10	1	U1	Si5xx - Not populated	Si5xx	Skyworks

4. Layout

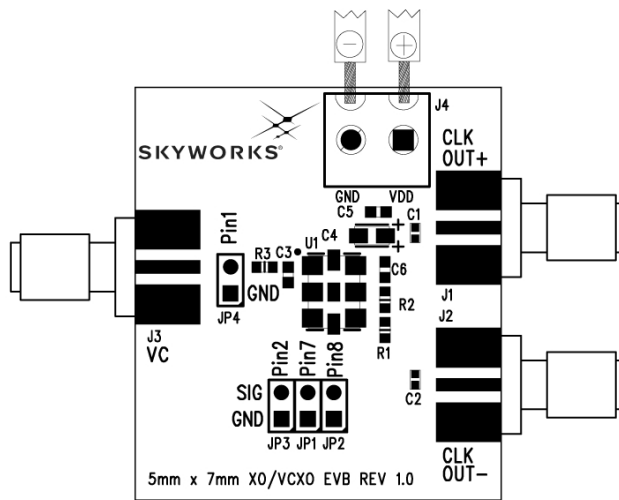

Figure 2. Assembly Drawing

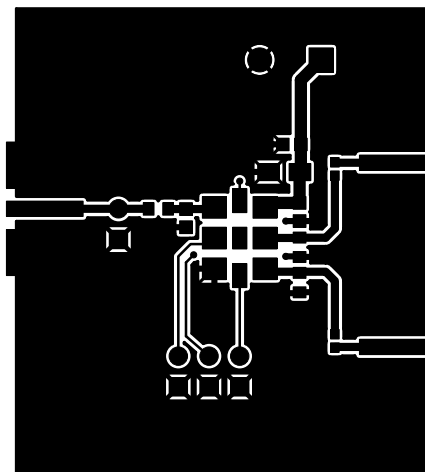

Figure 3. Layer 1 Primary

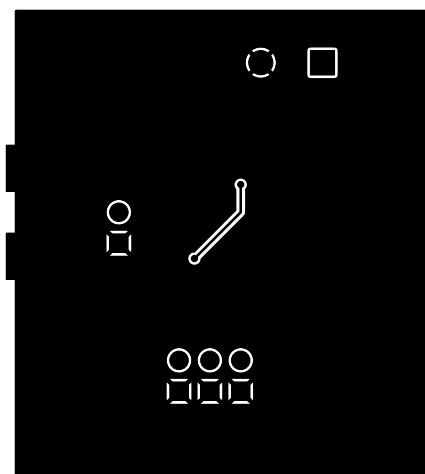

Figure 4. Layer 2 Secondary

Si5xx5x7-EVB

DOCUMENT CHANGE LIST

Revision 0.13 to Revision 0.14

- Updated "Bill of Materials," on page 4.
- Updated Figure 2, "Assembly Drawing," on page 5.

Revision 0.14 to Revision 0.2

- Changed Si5xx-EVB to Si5xx5x7-EVB.

Revision 0.2 to Revision 0.3

- Changed instances of Si53x/590/591, Si55x, and Si53x to Si53x/55x/59x throughout.
- Updated Table 1, "Jumper Control," on page 2.

NOTES:



SKYWORKS®

ClockBuilder Pro

Customize Skyworks clock generators, jitter attenuators and network synchronizers with a single tool. With CBPro you can control evaluation boards, access documentation, request a custom part number, export for in-system programming and more!

www.skyworksinc.com/CBPro



Portfolio

www.skyworksinc.com/ia/timing



SW/HW

www.skyworksinc.com/CBPro

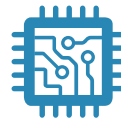

Quality

www.skyworksinc.com/quality



Support & Resources

www.skyworksinc.com/support

Copyright © 2021 Skyworks Solutions, Inc. All Rights Reserved.

Information in this document is provided in connection with Skyworks Solutions, Inc. ("Skyworks") products or services. These materials, including the information contained herein, are provided by Skyworks as a service to its customers and may be used for informational purposes only by the customer. Skyworks assumes no responsibility for errors or omissions in these materials or the information contained herein. Skyworks may change its documentation, products, services, specifications or product descriptions at any time, without notice. Skyworks makes no commitment to update the materials or information and shall have no responsibility whatsoever for conflicts, incompatibilities, or other difficulties arising from any future changes.

No license, whether express, implied, by estoppel or otherwise, is granted to any intellectual property rights by this document. Skyworks assumes no liability for any materials, products or information provided hereunder, including the sale, distribution, reproduction or use of Skyworks products, information or materials, except as may be provided in Skyworks' Terms and Conditions of Sale.

THE MATERIALS, PRODUCTS AND INFORMATION ARE PROVIDED "AS IS" WITHOUT WARRANTY OF ANY KIND, WHETHER EXPRESS, IMPLIED, STATUTORY, OR OTHERWISE, INCLUDING FITNESS FOR A PARTICULAR PURPOSE OR USE, MERCHANTABILITY, PERFORMANCE, QUALITY OR NON-INFRINGEMENT OF ANY INTELLECTUAL PROPERTY RIGHT; ALL SUCH WARRANTIES ARE HEREBY EXPRESSLY DISCLAIMED. SKYWORKS DOES NOT WARRANT THE ACCURACY OR COMPLETENESS OF THE INFORMATION, TEXT, GRAPHICS OR OTHER ITEMS CONTAINED WITHIN THESE MATERIALS. SKYWORKS SHALL NOT BE LIABLE FOR ANY DAMAGES, INCLUDING BUT NOT LIMITED TO ANY SPECIAL, INDIRECT, INCIDENTAL, STATUTORY, OR CONSEQUENTIAL DAMAGES, INCLUDING WITHOUT LIMITATION, LOST REVENUES OR LOST PROFITS THAT MAY RESULT FROM THE USE OF THE MATERIALS OR INFORMATION, WHETHER OR NOT THE RECIPIENT OF MATERIALS HAS BEEN ADVISED OF THE POSSIBILITY OF SUCH DAMAGE.

Skyworks products are not intended for use in medical, lifesaving or life-sustaining applications, or other equipment in which the failure of the Skyworks products could lead to personal injury, death, physical or environmental damage. Skyworks customers using or selling Skyworks products for use in such applications do so at their own risk and agree to fully indemnify Skyworks for any damages resulting from such improper use or sale.

Customers are responsible for their products and applications using Skyworks products, which may deviate from published specifications as a result of design defects, errors, or operation of products outside of published parameters or design specifications. Customers should include design and operating safeguards to minimize these and other risks. Skyworks assumes no liability for applications assistance, customer product design, or damage to any equipment resulting from the use of Skyworks products outside of Skyworks' published specifications or parameters.

Skyworks, the Skyworks symbol, Sky5®, SkyOne®, SkyBlue™, Skyworks Green™, Clockbuilder®, DSPLL®, ISOModem®, ProSLIC®, and SiPHY® are trademarks or registered trademarks of Skyworks Solutions, Inc. or its subsidiaries in the United States and other countries. Third-party brands and names are for identification purposes only and are the property of their respective owners. Additional information, including relevant terms and conditions, posted at www.skyworksinc.com, are incorporated by reference.

Skyworks Solutions, Inc. | Nasdaq: SWKS | sales@skyworksinc.com | www.skyworksinc.com

USA: 781-376-3000 | Asia: 886-2-2735 0399 | Europe: 33 (0)1 43548540 |    

Looking for pricing, stock, or lifecycle information?

Click below to explore more details on WIN SOURCE:

- ⊖ [View SI5XX5X7-EVB on WIN SOURCE](#)
- ⊖ [Skyworks Solutions Inc. Information](#)

Optimize Your Supply Chain with WIN SOURCE Solutions

- ✓ Global Sourcing Solution
- ✓ Obsolete Management
- ✓ Cost Control Management
- ✓ Shortage Management
- ✓ Alternative Solution
- ✓ Excess Inventory Management