



# THE DATASHEET OF SD303EVK



# SD303EVK / SD307EVK LMH0303 / LMH0307 Evaluation Board User Guide

National Semiconductor  
EVK User Manual

February 3, 2010



## Overview

The SD303/SD307 Evaluation Kit (EVK) enables evaluation of the LMH0303 3G/HD/SD SDI Cable Driver with Cable Detect or the LMH0307 3G/HD/SD SDI Dual Cable Driver with Cable Detect. A graphical user interface allows managing the SMBus registers of the LMH0303 or LMH0307 device.

## Evaluation Kit (SD303EVK / SD307EVK) Contents

The EVK contains the following parts:

- SD303/SD307 EVK board assembly with either the LMH0303 or LMH0307 cable driver
- USB cable
- SD303/SD307 EVK User Guide

## Evaluation Board Description

The evaluation board comes in two versions, depending on the cable driver installed:

- 1) SD303 with the LMH0303 cable driver
- 2) SD307 with the LMH0307 dual cable driver

The two cable drivers share the same evaluation board (SD303/SD307). The SD303/SD307 evaluation board silk screen shows the LMH0307 pin name terminology. Table 1 shows the pin name differences between the LMH0307 and LMH0303. The LMH0303 has a single output channel, SDO/SDO. The LMH0307 has that same output channel and refers to it as SDO0/SDO0. In addition, the LMH0307 adds a second output channel: SDO1/SDO1.

**Table 1. LMH0307 and LMH0303 Pin Name Comparison**

Reference	LMH0307 Name	LMH0307 Description	LMH0303 Name	LMH0303 Description
J3	SDO0	Channel 0 true output	SDO	True output
J4	SDO0	Channel 0 complement output	SDO	Complement output
J5	SDO1	Channel 1 true output		
J6	SDO1	Channel 1 complement output		
D9	TF0P	SDO0 Termination Fault	TFP	SDO Termination Fault
D10	TF0N	SDO0 Termination Fault	TFN	SDO Termination Fault
D8	TF1P	SDO1 Termination Fault		
D7	TF1N	SDO1 Termination Fault		

Figure 1 shows the SD303/SD307 evaluation board.

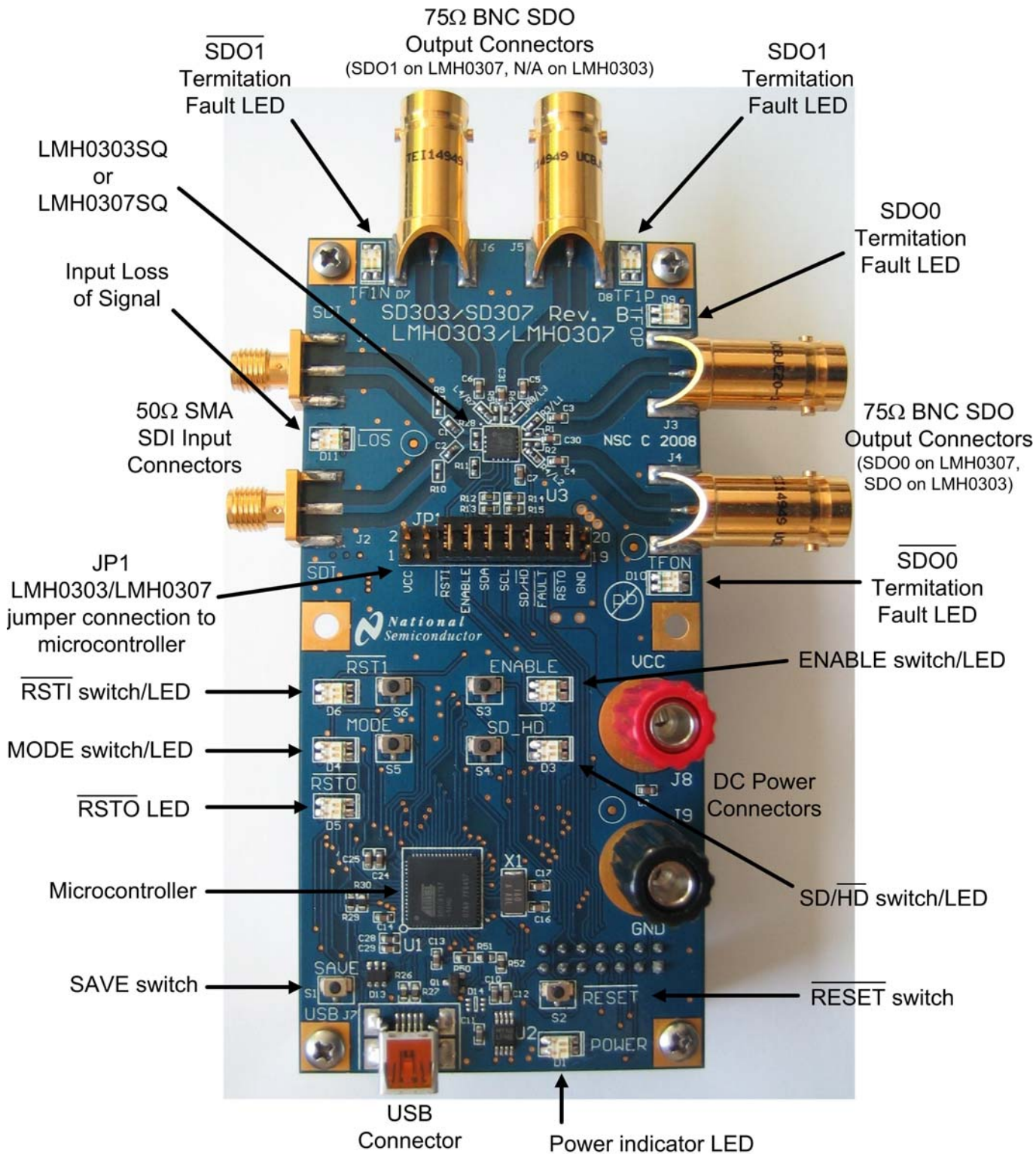

Figure 1. SD303/SD307 Evaluation Board

## SDI Input and SDO Output

The SDI input connectors (J1 and J2) are 50Ω SMA connectors. The SD303/SD307 is initially configured for 100Ω differential input. To configure the SD303/SD307 for 50Ω single-ended input, remove R28 and place 49.9Ω 0402 resistors in R9 and R10. When using only one input, the other input should be terminated with a 50Ω SMA termination.

The SDO output connectors (J3 and J4 for the SD303; and J3, J4, J5, and J6 for the dual output SD307) are 75Ω BNC connectors. When using only one side of an output pair, the other side should be terminated with a 75Ω BNC termination. For example, when only using SDO0 on the LMH0307, SDO0 should be terminated with a 75Ω BNC termination.

## DC Power Connectors and USB Connector

The red and black binding posts (J8 and J9) provide power for the LMH0303/LMH0307 device, and the USB connection provides power for the remaining board functions, including the microcontroller and the LEDs. **For proper operation, the SD303/SD307 should first be powered with a DC input voltage (between J8 and J9) of 3.3V ± 5% (3.6V maximum), and then the USB cable should be connected between the evaluation board and the PC.** The POWER LED will flash Red while the board is powered from the 3.3 VDC supply alone, and then change to solid Green once the USB cable is connected to the PC. The POWER LED will remain Green as long as the board is powered correctly.

## JP1 – LMH0303/LMH0307 Jumper Connection to Microcontroller

A jumper block should be placed on JP1 to connect the LMH0303/LMH0307 pins to the microcontroller. The ALP software will not function correctly if this jumper block is not in place. Separate jumpers may be used, but they must be placed to connect the following pins of JP1: RSTI (pins 5-6), ENABLE (pins 7-8), SDA (pins 9-10), SCL (pins 11-12), SD/HD (pins 13-14), FAULT (pins 15-16), and RSTO (pins 17-18). This jumper block (or individual jumpers) may be removed to control the LMH0303/LMH0307 pins externally, but then the microcontroller will no longer be able to communicate with the cable driver.

## Controls and Indicators

### ENABLE

The ENABLE push button switch controls ENABLE, and the ENABLE LED shows its state. The ENABLE LED is Green when the cable driver is enabled (ENABLE = 1), and Red when the cable driver is disabled (ENABLE = 0). When the cable driver is disabled, it enters a deep power down mode, and Termination Fault detection and LOS detection no longer function.

If the LOSEN register bit (bit 4 of register 05h) is set, then the cable driver can be disabled with LOS detection still functioning. With LOSEN set, LOS is combined with the ENABLE functionality. In this mode, disabling the device by pushing the ENABLE switch will still power down the device completely (including powering down Termination Fault detection and LOS detection), but if ENABLE is left active and the signal is removed from the input, the device will power down with the LOS detection still functioning. When the input signal is reapplied, the device will power back on.

### SD/HD

The SD/HD push button switch controls SD/HD, and the SD/HD LED shows its state. The SD/HD LED is Green when the cable driver is configured for HD/3G edge rates (SD/HD = 0), and Red when the cable driver is configured for SD edge rates (SD/HD = 1). The default setting for the SD/HD LED is Green for HD/3G edge rates.

## RSTI

The RSTI push button switch controls  $\overline{\text{RSTI}}$ , and the  $\overline{\text{RSTI}}$  LED shows its state.  $\overline{\text{RSTI}}$  is used to reset the cable driver to its default register settings. The  $\overline{\text{RSTI}}$  LED is Green during normal operation ( $\overline{\text{RSTI}} = 1$ ), and Red when the cable driver is held in reset ( $\overline{\text{RSTI}} = 0$ ). To reset the device, the RSTI switch must be pushed twice to fully toggle reset: once to put the device in reset mode ( $\overline{\text{RSTI}} = 0$ ), and again to resume normal operation ( $\overline{\text{RSTI}} = 1$ ) with the default register settings.

## RSTO

The  $\overline{\text{RSTO}}$  LED shows the state of  $\overline{\text{RSTO}}$ . The  $\overline{\text{RSTO}}$  LED is normally Red to indicate  $\overline{\text{RSTO}} = 0$ .  $\overline{\text{RSTO}}$  is the reset output used when daisy chaining multiple cable drivers on the same SMBus. After writing a new device address to register 00h (the ID register), the  $\overline{\text{RSTO}}$  LED changes to Green to indicate  $\overline{\text{RSTO}} = 1$ .  $\overline{\text{RSTO}}$  remains high until the device is reset with RSTI.

## Termination Faults (TFxx)

The Termination Fault LEDs show the state of the Termination Faults on the cable driver outputs. The Termination Fault LEDs are Green to indicate proper termination, Red to indicate improper or missing termination, and off to indicate the Termination Faults are not valid under the current cable driver conditions.

The cable driver must be enabled and must have a valid input signal in order to properly detect cable termination on the output. If no signal is detected and the  $\overline{\text{LOS}}$  LED is Red, then the Termination Fault detectors (TF1P, TF1N, TF0P, and TF0N for the LMH0307) cannot determine the state of the output termination and the LEDs will be off. When a valid input signal is applied, the Termination Fault detectors will show the correct state of their termination. If the cable driver is disabled or if the output channel is powered down, the Termination Fault LEDs will be off.

## LOS

The  $\overline{\text{LOS}}$  LED shows the status of the input signal detector. The  $\overline{\text{LOS}}$  LED is Green to indicate a valid input signal ( $\overline{\text{LOS}} = 1$ ), and Red when no signal is detected ( $\overline{\text{LOS}} = 0$ ). When the cable driver is disabled ( $\text{ENABLE} = 0$ ), the  $\overline{\text{LOS}}$  detection is disabled as well and the  $\overline{\text{LOS}}$  LED will be Red to indicate no signal can be detected. If the  $\overline{\text{LOS}}$  LED is Red, then the Termination Fault detection does not function and the TFxx LEDs are forced off.

With the LOSEN register bit (bit 4 of register 05h) set, the  $\overline{\text{LOS}}$  detection may still function while the cable driver is disabled. In this mode,  $\overline{\text{LOS}}$  is combined with the ENABLE functionality, and if the input signal is removed then the cable driver will power down but keep the  $\overline{\text{LOS}}$  detection running. The device will power back on once an input signal is detected. (While in this mode, disabling the device by pushing the ENABLE switch will still power down the device completely, including powering down Termination Fault and  $\overline{\text{LOS}}$  detection).

## LEDs and Push Button Switches Summary

Table 2 shows a summary of the LEDs provided to assist the user in determining the configuration of the board, and Table 3 shows a summary of the push button switches provided to allow control of the board functions.

**Table 2. SD303/SD307 LED Indicators**

LED	Reference	Default after Reset *	Function when GREEN	Function when RED	Function when OFF
D1	POWER	Green	POWER=1, board powered	When flashing Red, indicates the 3.3 VDC supply is connected but the USB is not	Board not powered
D2	ENABLE	Green	ENABLE=1, device enabled	ENABLE=0, device powered down	N/A
D3	SD/HD	Green	SD/HD=0, HD/3G mode	SD/HD=1, SD mode	N/A
D4	MODE	Off	N/A	N/A	No function, LED always off
D5	RSTO	Red	RSTO =1	RSTO =0	N/A
D6	RSTI	Green	RSTI =1, normal operation	RSTI =0, device held in reset	N/A
D7	TF1N	Off	TF1N=0, SDO1 properly terminated	TF1N=1, Termination Fault on SDO1	Termination Fault not valid (channel is powered down or no input signal detected)
D8	TF1P	Off	TF1P=0, SDO1 properly terminated	TF1P=1, Termination Fault on SDO1	Termination Fault not valid (channel is powered down or no input signal detected)
D9	TF0P	Off	TF0P=0, SDO0 properly terminated	TF0P=1, Termination Fault on SDO0	Termination Fault not valid (channel is powered down or no input signal detected)
D10	TF0N	Off	TF0N=0, SDO0 properly terminated	TF0N=1, Termination Fault on SDO0	Termination Fault not valid (channel is powered down or no input signal detected)
D11	LOS	Red	LOS =1, signal detected at input	LOS =0, no input signal detected	N/A

\* Shows the default value after the board is reset (or initially powered on) with no input signal.

**Table 3. SD303/SD307 Push Button Controls**

Control	Reference	Description
S1	SAVE	No function.
S2	RESET	Push to completely reset the board, device, and ALP software.
S3	ENABLE	Toggles ENABLE. Push to set ENABLE=0 and power down the device. Push again to set ENABLE=1 and re-enable the device.
S4	SD/HD	Toggles SD/HD. Push to set SD/HD=1 and enable SD mode. Push again to set SD/HD=0 and enable HD/3G mode.
S5	MODE	No function.
S6	RSTI	Toggles RSTI. Push once to set RSTI =0 and reset the device. Push again to set RSTI =1 and return to normal operation following the reset.

# Software Setup

## System Requirements

**Operating System:** Windows XP or Vista  
**USB:** 2.0

## Installation

Download the latest software from [http://www.national.com/analog/interface/sd303\\_307evk](http://www.national.com/analog/interface/sd303_307evk). Extract the ALPF\_monthdayyear\_major version\_minor version.exe" (ex. ALPF\_07312008\_125\_0016.exe) file to a temporary location that can be deleted later.

Make sure the evaluation board is not connected to the PC. The following installation instructions are for the Windows XP Operating System.

### Install the ALP software

Execute the ALP Setup Wizard program called "ALPF\_monthdayyear\_major version\_minor version.exe" (ex. ALPF\_07312008\_125\_0016.exe) that was extracted to a temporary location.

There are 7 steps to the installation once the setup wizard is started:

1. Select the "Next" button.
2. Select "I accept the agreement" and then select the "Next" button.
3. Select the location to install the ALP software and then select the "Next" button.
4. Select the location for the start menu shortcut and then select the "Next" button.
5. There will then be a screen that allows the creation of a desktop and Quick Launch icon. After selecting the desired choices select the "Next" button.
6. Select the "Install" button, and the software will then be installed to the selected location.
7. Uncheck "Launch Analog LaunchPAD" and select the "Finish" button. The ALP software will start if "Launch Analog LaunchPAD" is checked, but it will not be useful until the USB driver is installed.

Power on the SD303/SD307 evaluation board with a 3.3 VDC power supply. Numerous LEDs will turn on, and the POWER LED will flash Red. Connect the PC and the SD303/SD307 evaluation board together with the USB cable. The POWER LED will stop flashing, and the "Found New Hardware Wizard" will open on the PC. Proceed to the next section to install the USB driver.

### Install the USB driver

There are 6 steps to install the USB driver:

1. Select "No, not at this time" then select the "Next" button.
2. Select "Install from a list or specific location" then select the "Next" button.
3. Select "Search for the best driver in these locations". Uncheck "Search removable media" and check "Include this location in the search".
4. Browse to the Install Directory which is typically located at "C:\Program Files\National Semiconductor Corp\Analog LaunchPAD\vx.x.x\Drivers" and select the "Next" button. Windows should find the driver.
5. Select "Continue Anyway".
6. Select the "Finish" button.

The software installation is complete. The POWER LED on the board should turn to solid Green. The ALP software may now be launched, as described in the next section.

# Software Description

## Startup

Make sure all the software has been installed and the hardware is powered on and connected to the PC. Execute “Analog LaunchPAD” from the start menu. The default start menu location is “Programs\National Semiconductor Corp\Analog LaunchPAD vx.x.x\Analog LaunchPAD”.

The application should come up in the state shown below (for the LMH0307). If it does not, see “Trouble Shooting” at the end of this document.

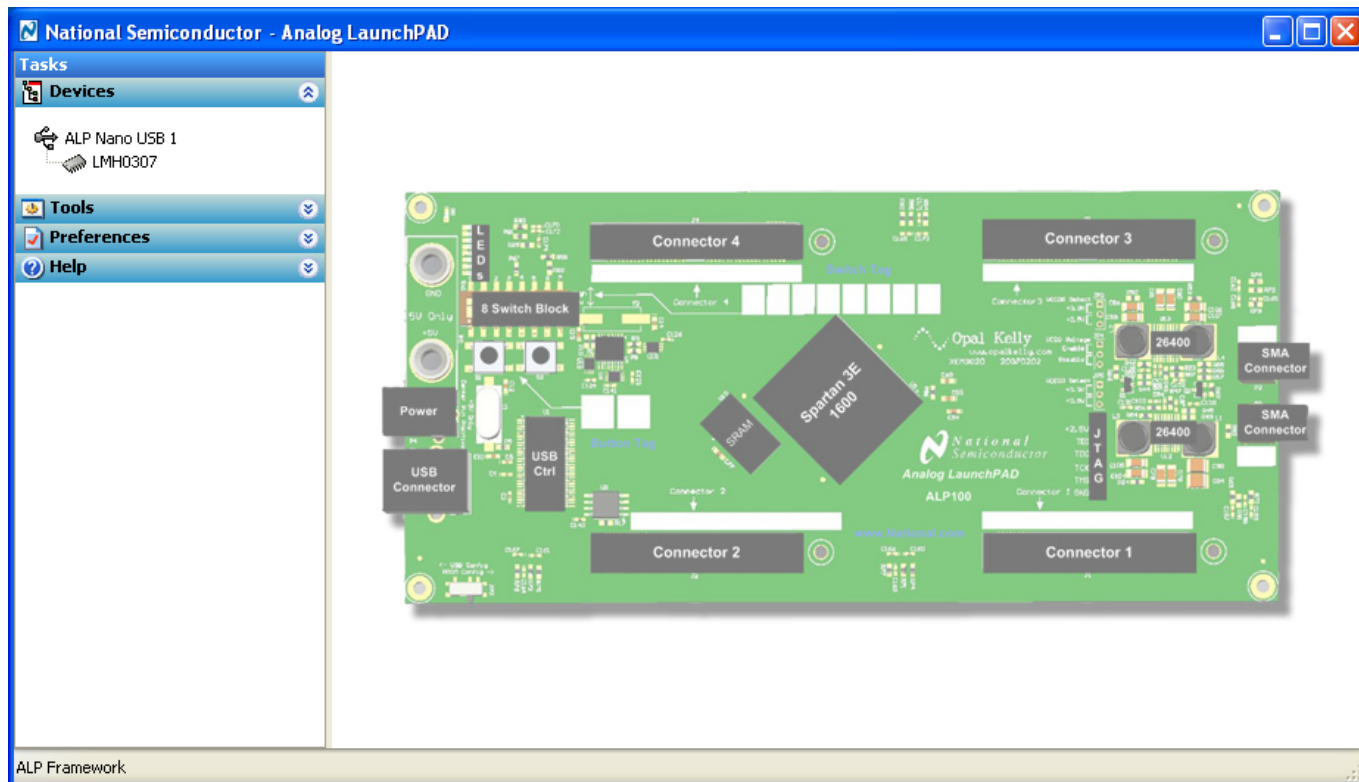

Figure 2. ALP Startup Screen for LMH0307

## LMH0303/LMH0307 Profiles

There are separate profiles for the LMH0303 and the LMH0307. The ALP software automatically detects which device is connected and configures the profile accordingly. There are four application tabs for the LMH0303/LMH0307 device.

## Information Tab

The Information tab is shown in Figure 3 (for the LMH0307).

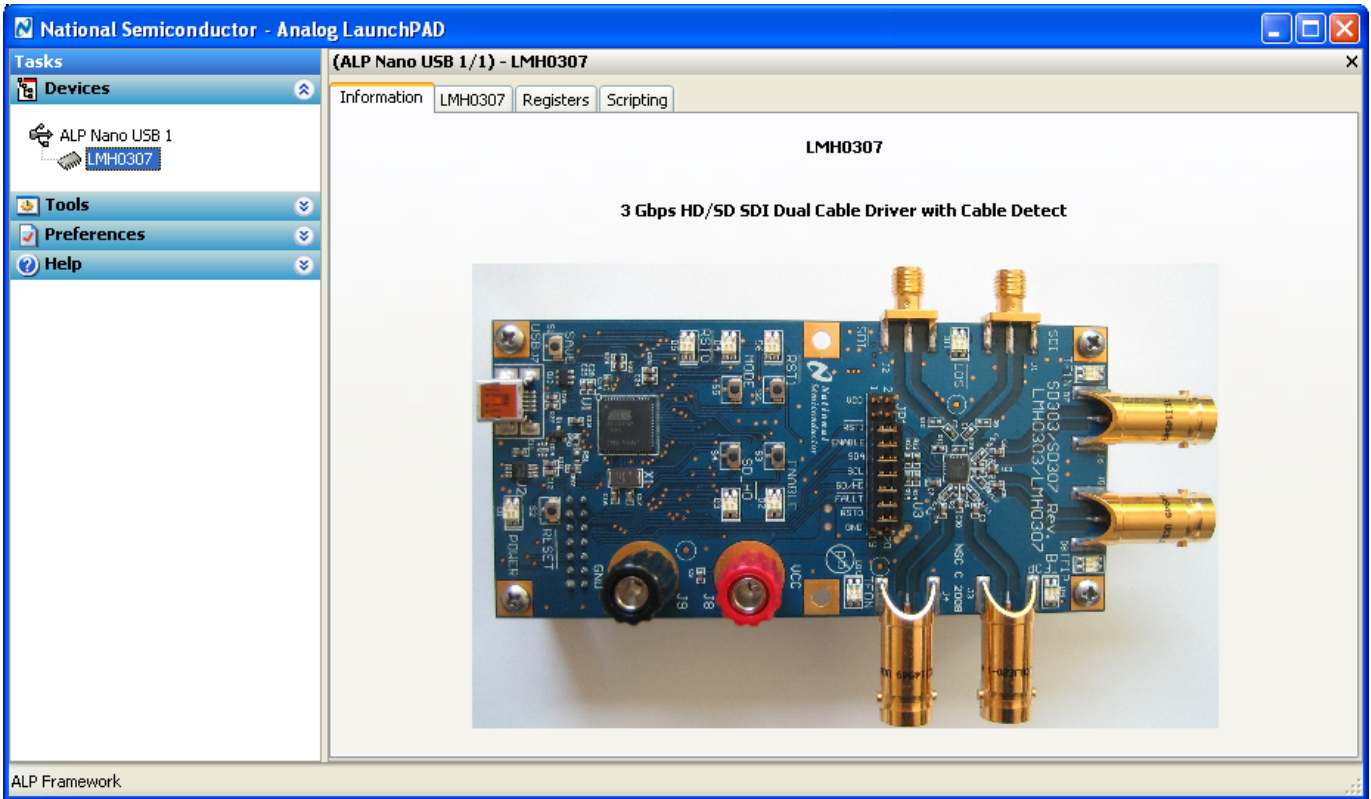

Figure 3. LMH0307 Information Tab

### LMH0303 and LMH0307 Tab

The LMH0303/LMH0307 tabs present a high level view of the cable driver. Figure 4 shows this tab for the LMH0307, and Figure 5 shows this tab for the LMH0303.

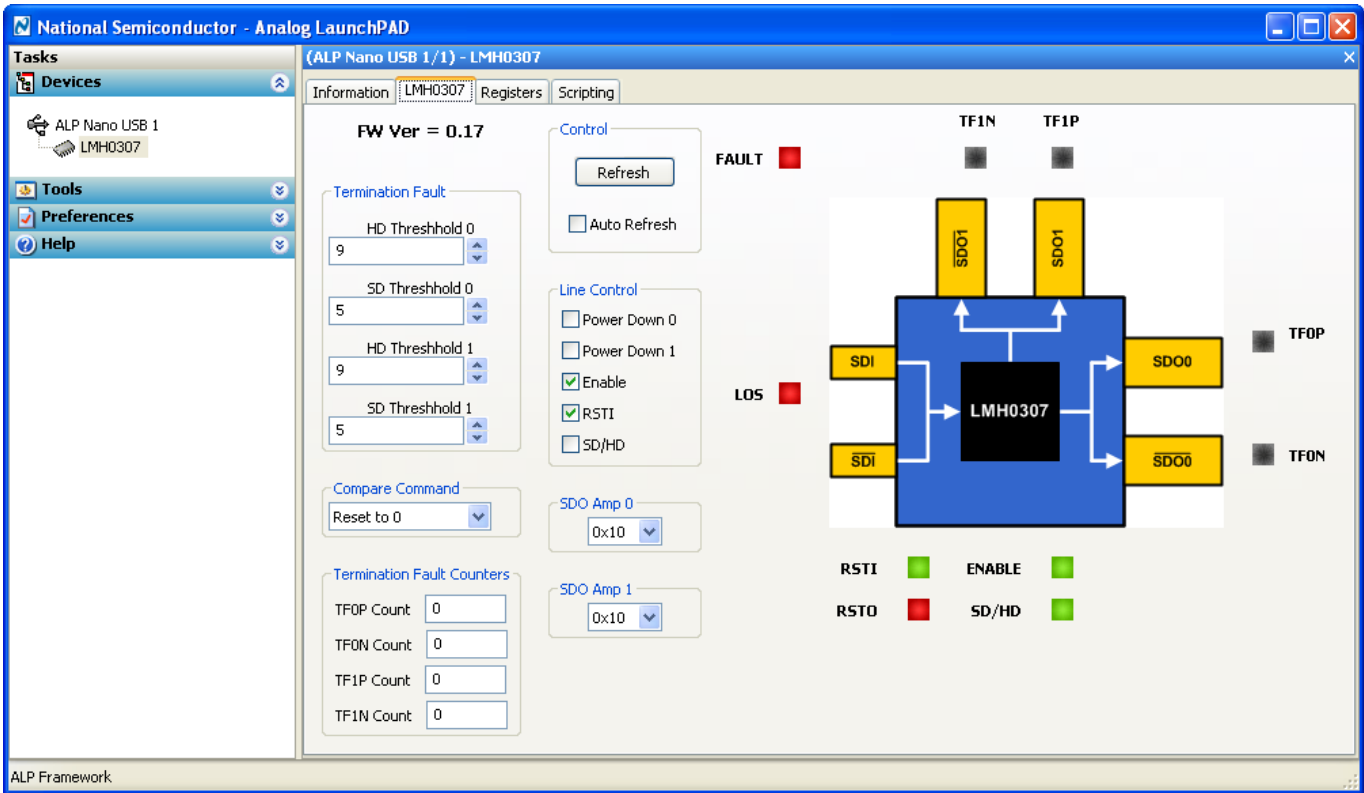

Figure 4. LMH0307 Main Tab

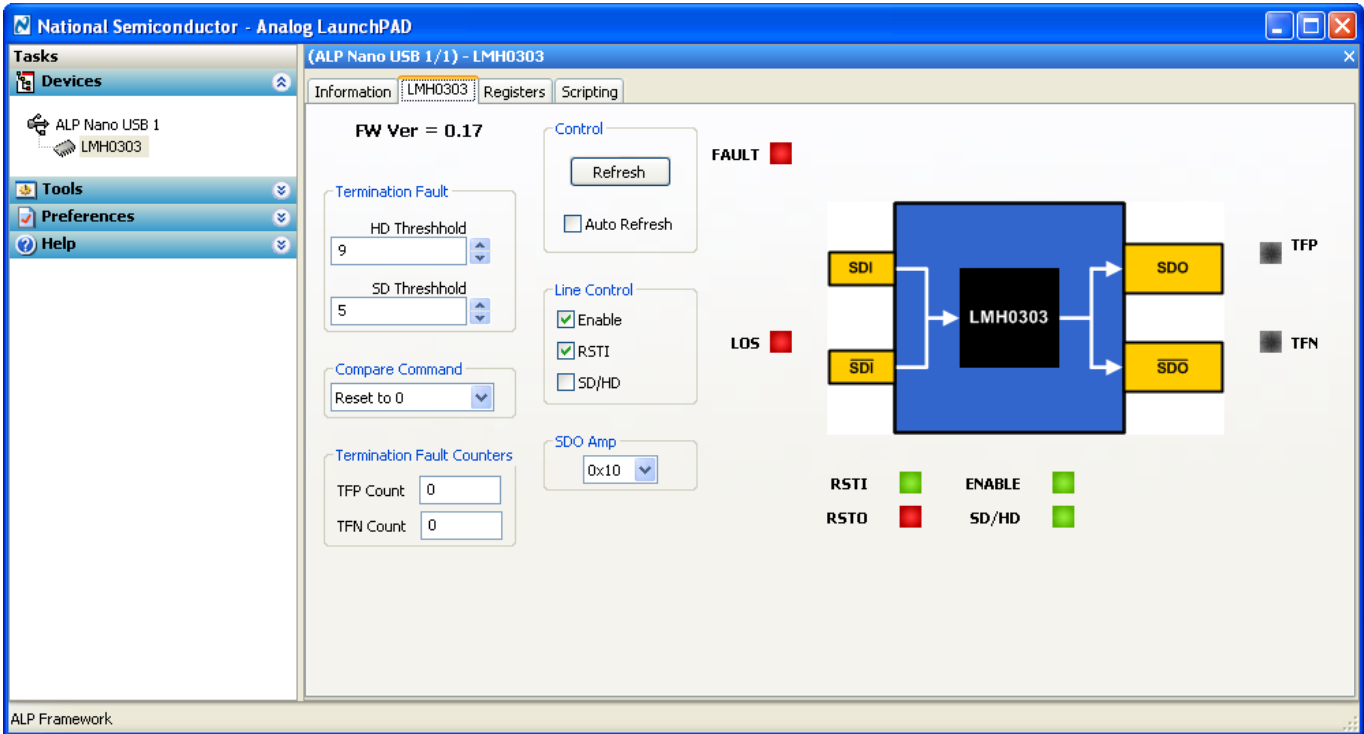

Figure 5. LMH0303 Main Tab

## **Firmware Version – FW Ver**

FW Ver shows the version of the firmware installed on the evaluation board.

## **Termination Fault**

These controls show the default configuration of the HD and SD Termination Fault Threshold registers and also provide the ability to change the thresholds. The LMH0307 has two pairs of Termination Fault Threshold registers – one HD/SD pair for each of its two output channels – as shown in Figure 4. The LMH0303 has only one HD/SD pair of Termination Fault Threshold registers for its single output channel, as can be seen in Figure 5.

Increasing the Termination Fault Threshold settings decreases the cable driver's sensitivity to Termination Faults. This is useful if the cable driver is indicating termination faults when the output appears to be properly terminated. Decreasing the Termination Fault Threshold settings increases the cable driver's sensitivity to Termination Faults which is useful for determining cable detection at the end of long cables.

## **Compare Command and Termination Fault Counters**

Compare Command configures the CMPCMD section of the TEST register (08h) on the LMH0303 or LMH0307. The Termination Fault Counters reflect the current configuration of the TEST register CMPCMD bits.

The Termination Fault Counters provide an indication of how the cable driver is reading the Termination Faults based on the current Termination Fault Threshold settings. Perfectly terminated outputs should read back "0", and unterminated outputs should read back "31".

## **Control**

### **Refresh**

The Refresh button provides a manual refresh of the state from the evaluation board to the LMH0303/LMH0307 tab. Changes to the board will not be reflected in the LED icons and Line Control checkboxes on the LMH0303/LMH0307 tab until the Refresh button is pressed. This can be done automatically by using the Auto Refresh checkbox.

### **Auto Refresh Checkbox**

The Auto Refresh checkbox provides an automatic refresh of the state from the evaluation board to the LMH0303/LMH0307 tab once per second. This provides automatic updating of the LED icons and Line Control checkboxes on the LMH0303/LMH0307 tab to reflect any board changes.

## **Line Control**

### **Power Down 0 and 1 (LMH0307 only)**

Power Down 0 and 1 checkboxes control the PD0 and PD1 power down bits (bits 5 and 6 in register 02h - MASK) and will selectively power down one or both of the output channels on the LMH0307.

### **Enable**

The Enable checkbox controls the associated ENABLE pin on the LMH0303/LMH0307. Disabling or un-checking the Enable checkbox will force the LMH0303/LMH0307 into a deep power down mode.

### **RSTI**

The RSTI checkbox controls the RSTI pin. This checkbox is checked for normal operation, and un-checked to put the cable driver in reset.

## SD/HD

The SD/HD checkbox controls the state of the SD/HD pin. This checkbox is un-checked by default to enable HD/3G mode. Enabling this checkbox sets the cable driver edge rates to SD mode.

## SDO Amp

The SDO Amp controls set the amplitude of the output driver(s). The LMH0307 has two independently configurable outputs (SDO0 and SDO1) and the LMH0303 has a single configurable output (SDO). For the LMH0307, SDO Amp 0 configures the AMP0 bits in the OUTPUT0 register (04h), and SDO Amp 1 configures the AMP1 bits in the OUTPUT1 register (06h). For the LMH0303, SDO Amp configures the AMP bits in the OUTPUT register (04h).

The default amplitude setting is 0x10 for 800 mV<sub>P-P</sub>. The output amplitude may be lowered to around 720 mV<sub>P-P</sub> and increased to around 880 mV<sub>P-P</sub> in roughly 5 mV increments.

## LED Icons

The diagram of the LMH0303/LMH0307 device is framed by a number of colored LED icons that represent the LED state on the board. Note that either the Refresh button or the Auto Refresh checkbox must be used to update the LED icons in the LMH0303/LMH0307 tab to reflect any board changes.

## FAULT LED

The FAULT LED shows the current state of the FAULT pin. The FAULT LED is Green to indicate no faults are detected (FAULT = 1) and Red to indicate one or more faults have been detected (FAULT = 0). The Auto Refresh checkbox should be checked in order to actively monitor the state of the FAULT pin.

FAULT is triggered and set low for a Termination Fault on any output or the loss of signal on the input. FAULT is cleared and set high again when the faults have been removed by either terminating the outputs, applying the input signal, or changing the register settings in the MASK or DIRECTION registers.

## Registers Tab

The Registers tab displays all registers for the LMH0303 or LMH0307. Figure 6 shows the Registers tab for the LMH0307. The Value field indicates the value of the currently selected register.

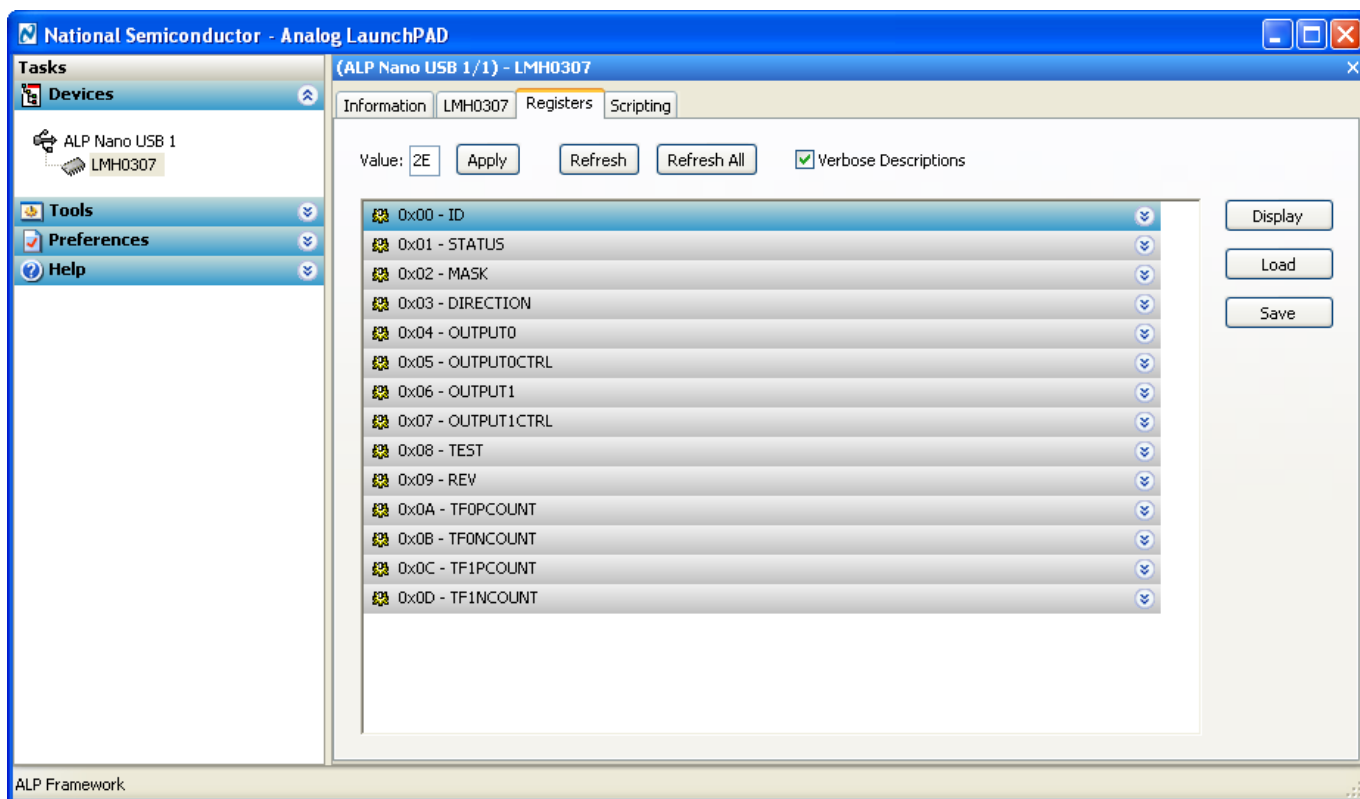

**Figure 6. LMH0307 Registers Tab**

Each register can be examined in detail by either double clicking on the desired registers fold bar (with the address and the register name, e.g. 0x00 – ID) or by single clicking the icon at the right of the fold bar (two inverted carats).

The Refresh button will re-read the currently selected register and the Refresh All will read all registers in the device. Changes may be made to the registers by checking or un-checking the individual register bits or typing in a new register value in the Value field. After setting the appropriate register value, the Apply button must be pressed to apply the changes. The detailed view of the STATUS register is shown in Figure 7 with Verbose Descriptions checked and Figure 8 with Verbose Descriptions un-checked.

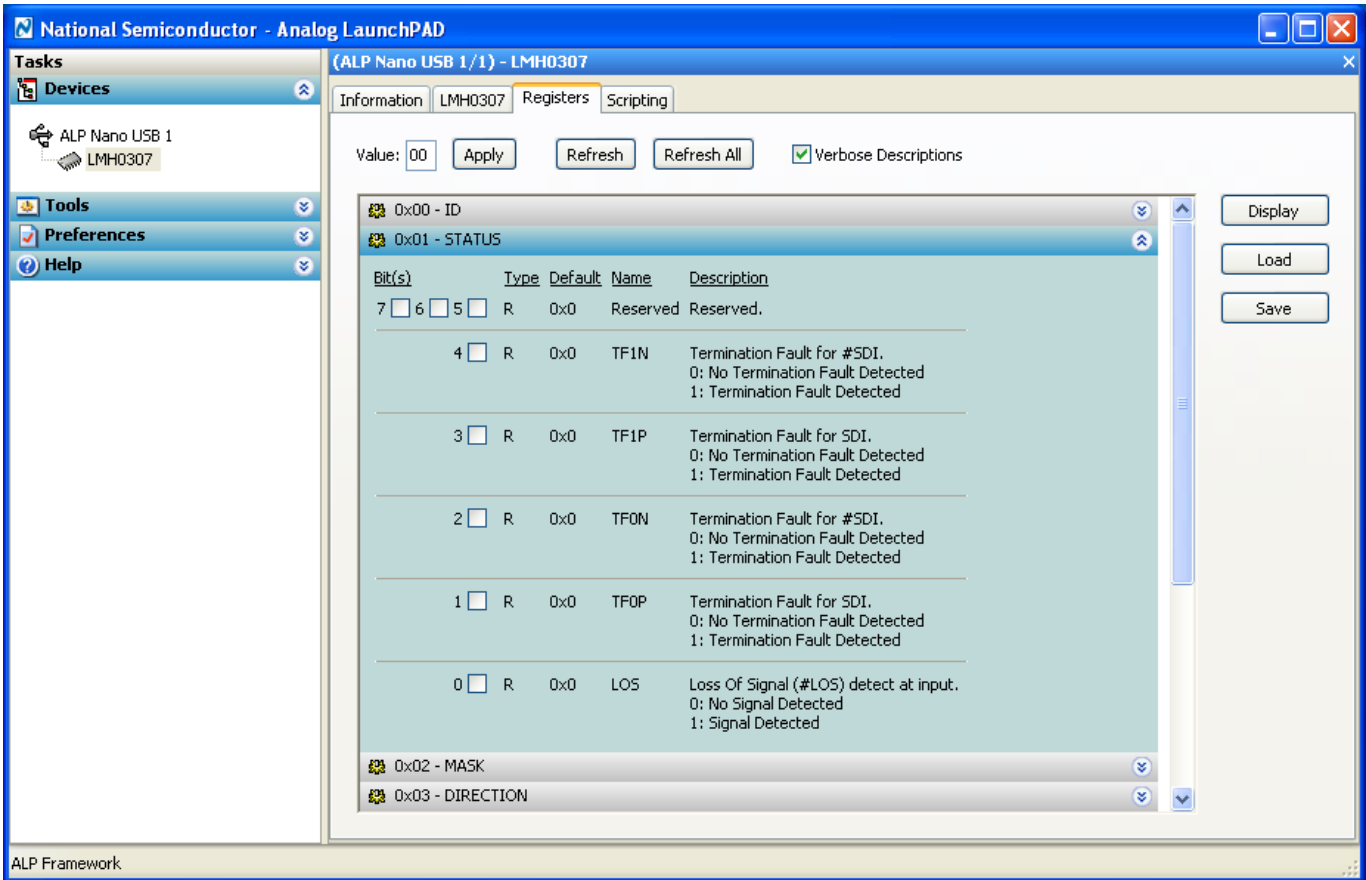

Figure 7. LMH0307 Registers Tab with Verbose Descriptions

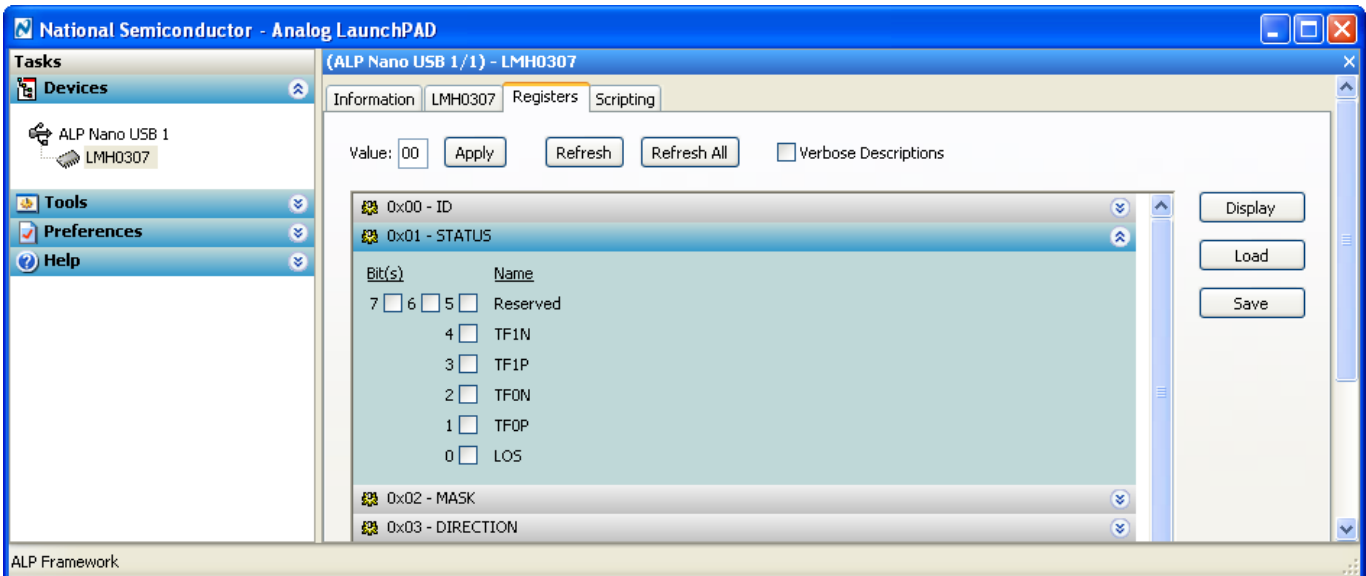
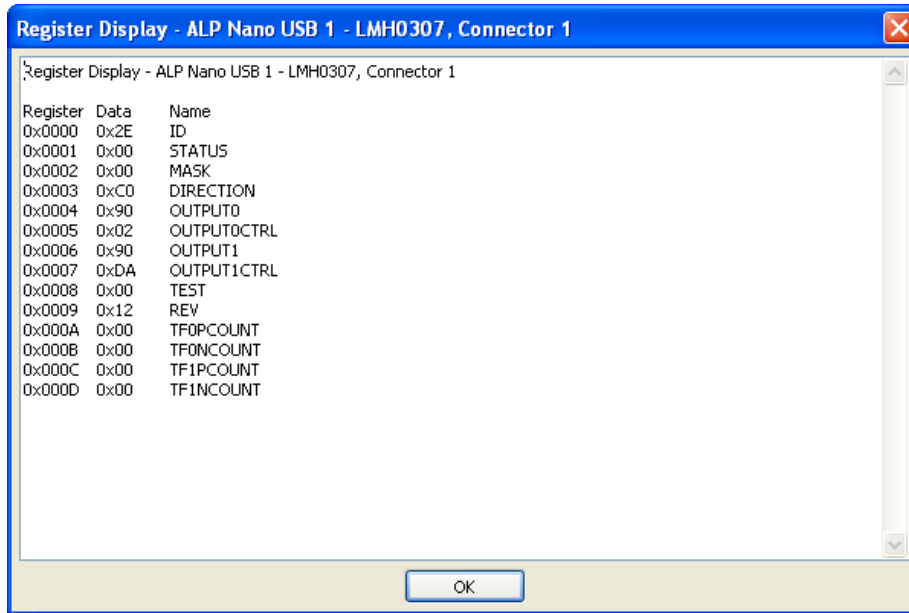

Figure 8. LMH0307 Registers Tab without Verbose Descriptions

The Display button provides another view of the register set and is depicted in Figure 9. The Display dialog supports the Windows copy command (Ctrl+c).



**Figure 9. LMH0307 Register Display**

The Load and Save buttons provide a handy mechanism for restoring or saving the register set external to the evaluation board.

## Cable Driver Output Waveform

### Test Conditions

The SDO0 output of the LMH0307 on the SD307 is observed in the following example. The input signal is a 2.97 Gbps PRBS10 from the Agilent 86130A 3.6G BERT. The input signal is connected differentially to the SDI SMA inputs on the evaluation board with matched 3' SMA cables. The LMH0307 is running in HD/3G mode (SD/HD=0). The SDO0 output is connected through 1m of Belden 1694A cable to the TCA75 input module on the Tektronix DSA 71254 12.5 GHz Oscilloscope. SDO0 is terminated with a 75Ω BNC terminator.

### Test Results

Figure 8 shows the typical SDO0 output waveform from the LMH0307.

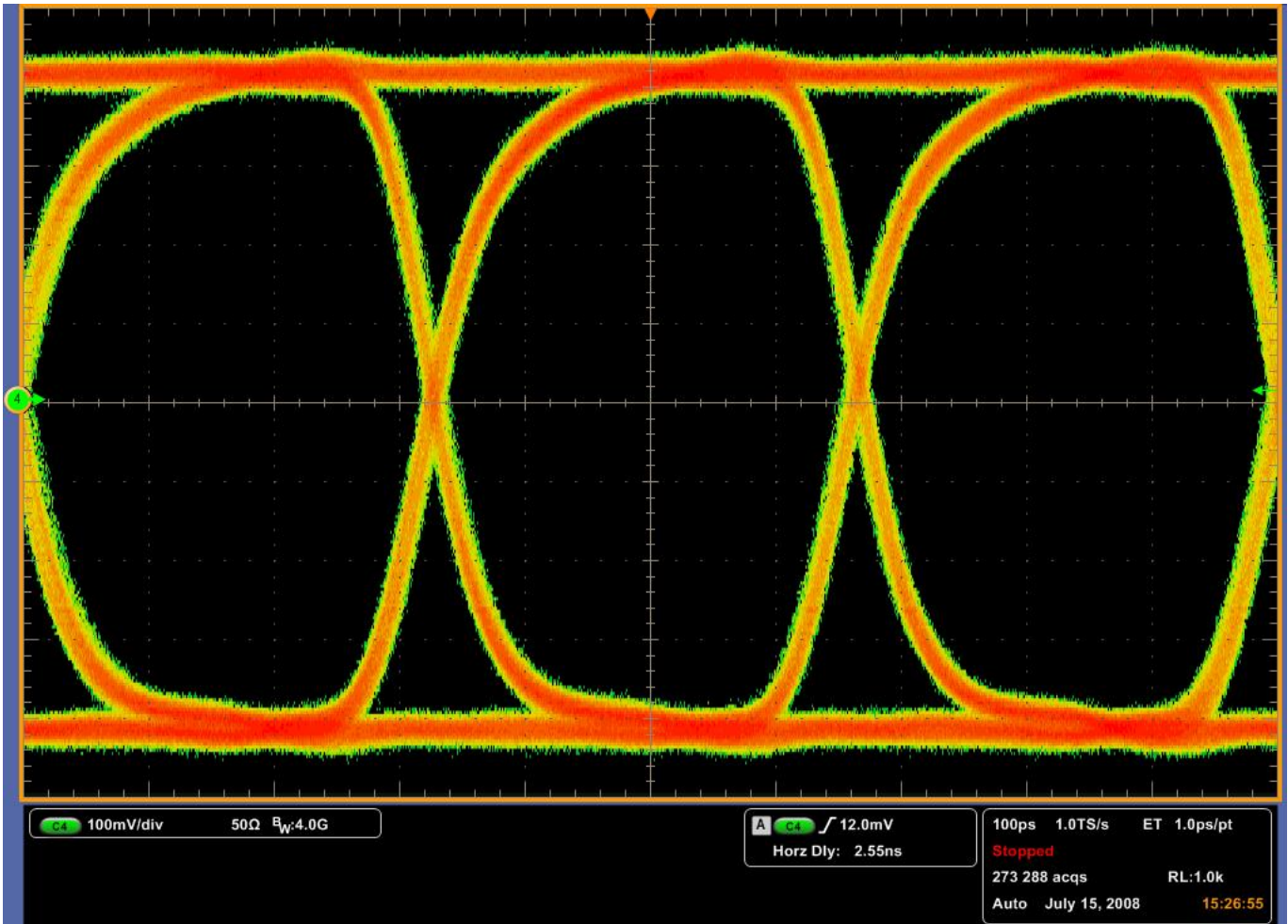
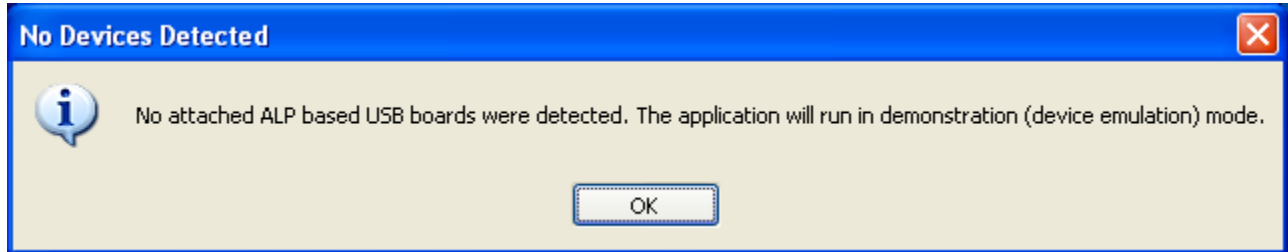

Figure 10. LMH0307 SDO0 Output Waveform at 2.97 Gbps

# Trouble Shooting

If the following window (Figure 11) opens after starting the ALP software, double check the hardware setup.



**Figure 11. Analog LaunchPAD No Devices Error**

It may also be that the USB driver is not installed. Check the device manager. There should be an "NSC ALP Nano Atmel" device under the "Universal Serial Bus Controllers" as shown below in Figure 12.

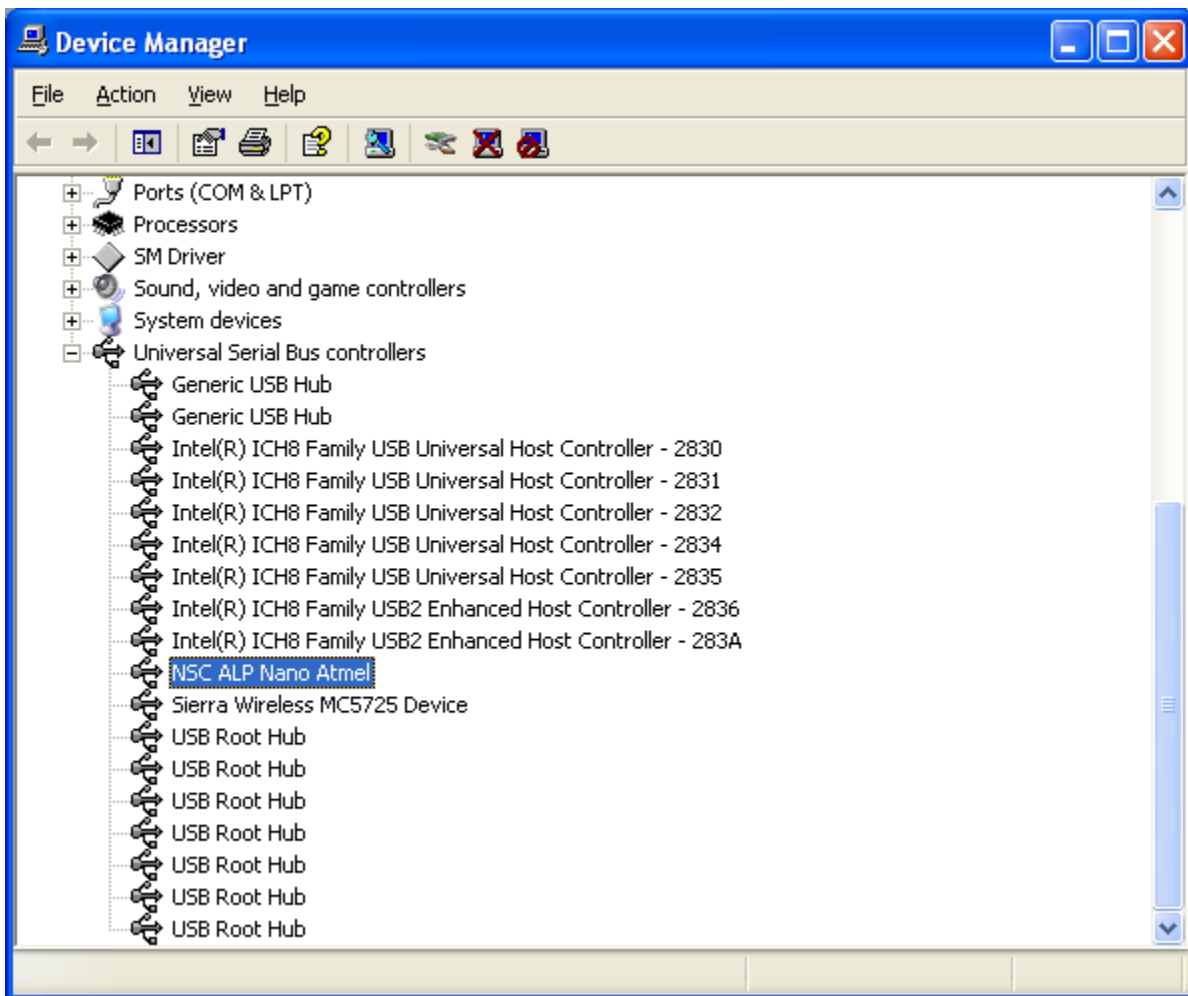

**Figure 12. Windows XP, Analog LaunchPAD USB Driver**

The software should start with only “LMH0303” or “LMH0307” in the “Devices” pull down menu. If there are more devices then the software is most likely in demo mode. When the ALP is operating in demo mode there is a “(Demo Mode)” indication in the lower left of the application status bar as shown in Figure 13.

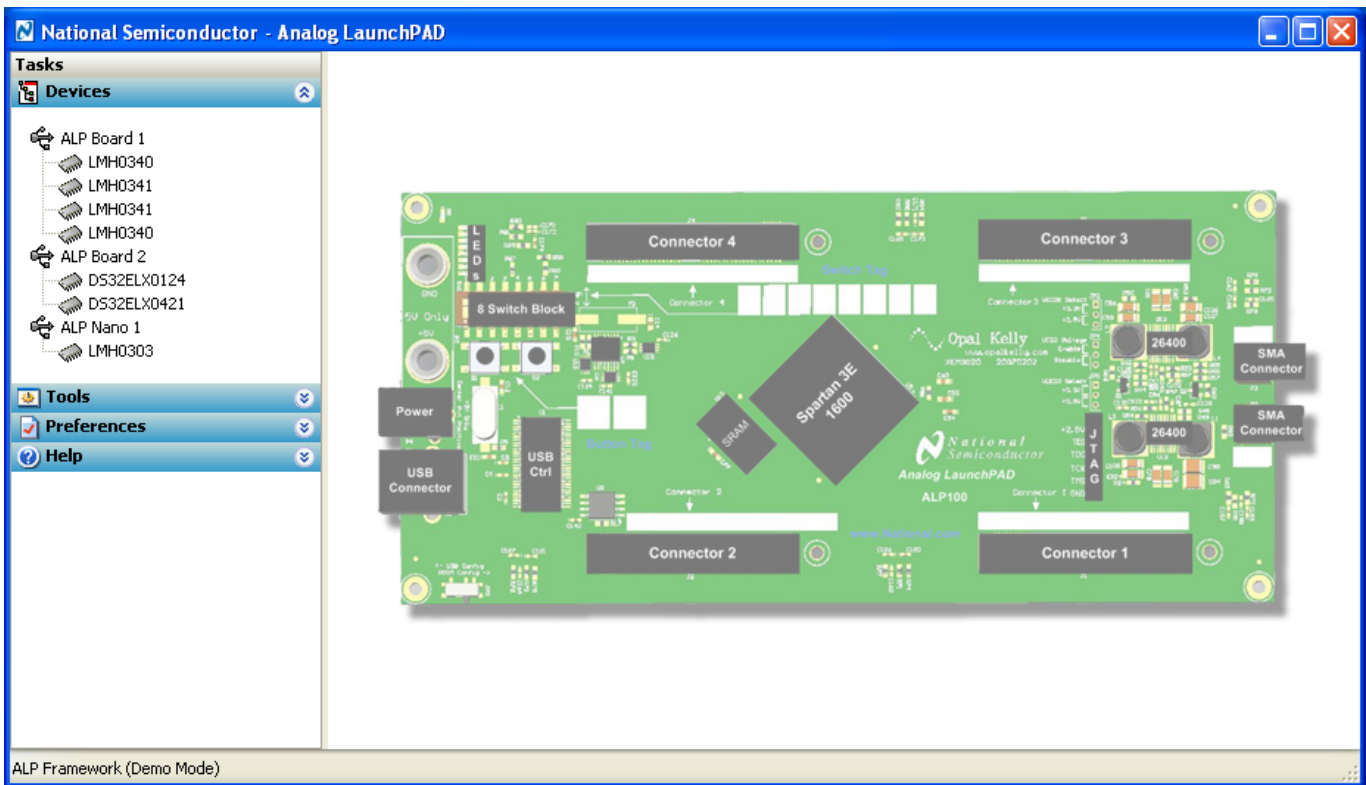

**Figure 13. Analog LaunchPAD in Demo Mode**

Disable the demo mode by selecting the “Preferences” pull down menu and un-checking “Enable Demo Mode”.

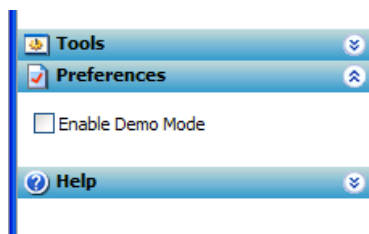

**Figure 14. Analog LaunchPAD Preferences Menu**

After demo mode is disabled, the ALP software will poll the ALP hardware. The ALP software will update and have only “LMH0303” or “LMH0307” under the “Devices” pull down menu.

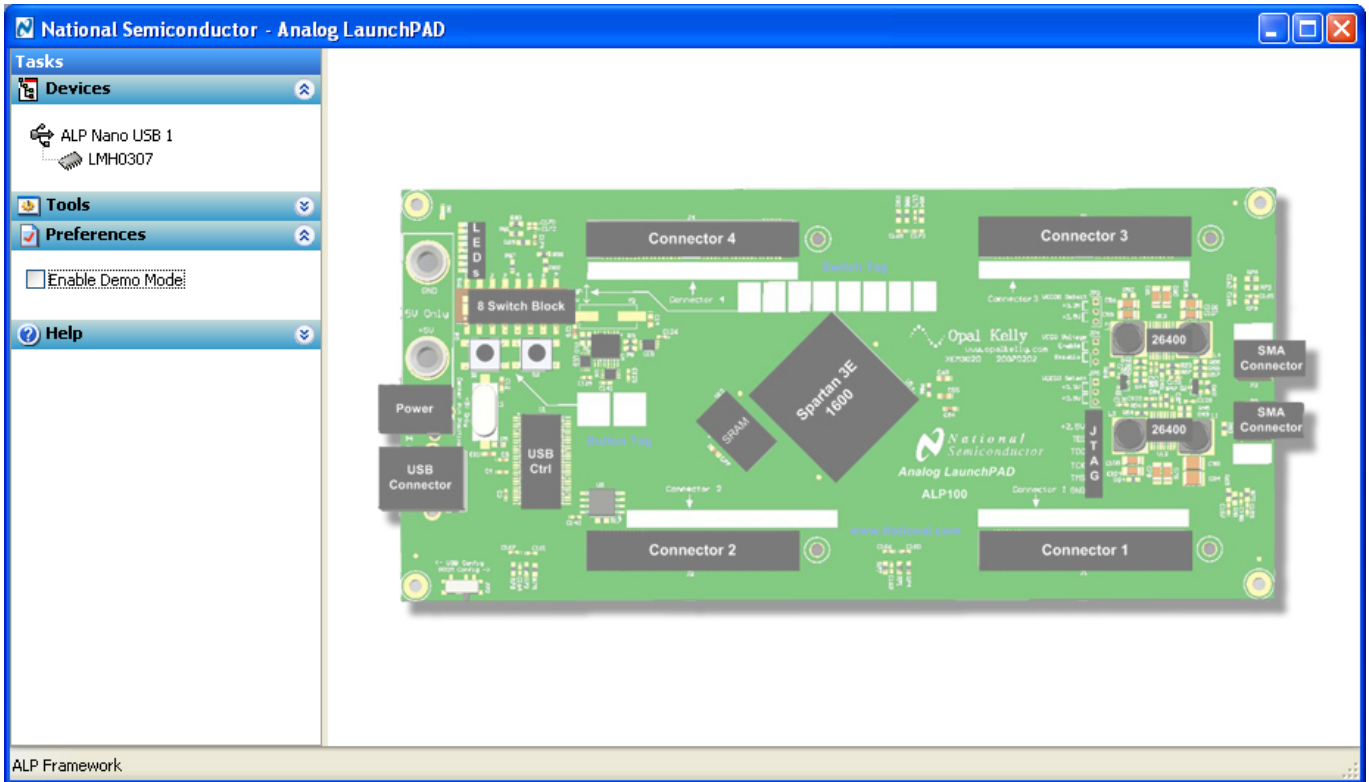

Figure 15. Analog LaunchPAD Screen with Demo Mode Off

# Bill of Materials

Reference Designator	Qty	Description	Manufacturer	Manufacturer Part No.
C1, C2	2	1uF Capacitor Ceramic 10V, 20%, X5R, 0402	Panasonic	ECJ-0EB1A105M
C3, C4, C5, C6, C10, C11, C14, C24, C26, C28	10	4.7uF Capacitor Ceramic 6.3V, 20%, X5R, 0603	Panasonic	ECJ-1VB0J475M
C7, C25, C27, C29	4	100pF Capacitor Ceramic 50V, 5%, C0G, 0603	Panasonic	ECJ-1VC1H101J
C8, C30, C31	3	0.1uF Capacitor Ceramic 50V, 10%, X7R, 0603	Panasonic	ECJ-1VB1H104K
C9	1	10uF Capacitor Ceramic 6.3V, 20%, X5R, 0603	Panasonic	ECJ-1VB0J106M
C12	1	0.033uF Capacitor Ceramic 50V, 10%, X7R, 0603	Panasonic	ECJ-1VB1H333K
C13, C15, C20, C21, C22, C23	6	1uF Capacitor Ceramic 16V, 10%, X5R, 0603	Panasonic	ECJ-1VB1C105K
C16, C17	2	12pF Capacitor Ceramic 50V, 5%, C0G, 0603	Panasonic	ECJ-1VC1H120J
C18, C19	2	220nF Capacitor Ceramic 10V, 10%, X5R, 0603	Panasonic	ECJ-1VB1A224K
D1, D2, D3, D4, D5, D6, D7, D8, D9, D10, D11	11	BiColored LED (Green, Red)	LITE-ON	LTST-C155KGJRKT
D13	1	Bidirectional ESD Transient Suppressor, SOT23-6	COMCHIP	CEBS0624V-G
D14	1	Diode Schottkey Array, 40V, SOT363	Diodes Inc	BAS40DW-05-7-F
J1, J2	2	SMA Connector (Edge Launch)	Johnson Components	142-0701-851
J3, J4, J5, J6	4	75 ohm BNC (Edge Launch)	Trompeter	UCBJE20-1
J7	1	USB Mini-B Recept, R/A, 5POS	Molex	54819-0572
J8	1	Binding Post (Banana Jack) Red	Emerson	111-0702-001
J9	1	Binding Post (Banana Jack) Black	Emerson	111-0703-001
JP1	1	10x2 Header, 0.100" spacing	Tyco Electronics	87215-7
JP2	1	7x2 Header, 0.100" spacing	Tyco Electronics	87215-4
L1, L2, L3, L4	4	6.8nH Inductor, 0402	Murata	LQP15MN6N8B02D
Q1	1	MOSFET, P-Ch, 12V, 4.3A, SOT-23	International Rectifier	IRLML6401TRPBF
R1, R2, R3, R4, R5, R6, R7, R8	8	75 ohm Resistor 1%, 1/16W, 0402	ROHM	MCR01MZPF75R0
R11	1	750 ohm Resistor 1%, 1/16W, 0402	Vishay	CRCW0402750RFKED
R12, R13, R14, R15, R32, R33, R34, R35, R36, R37	10	10k ohm Resistor 5%, 0.1W, 0603	ROHM	MCR03EZPJ103
R16, R18, R20, R22, R24, R40, R42, R44, R46, R48	10	300 ohm Resistor 5%, 0.1W, 0603	ROHM	MCR03EZPJ301
R17, R19, R21, R23, R25, R39, R41, R43, R45, R47, R49	11	270 ohm Resistor 5%, 0.1W, 0603	ROHM	MCR03EZPJ271
R26, R27	2	22 ohm Resistor 5%, 1/10W, 0603	ROHM	MCR03EZPJ220
R28	1	100 ohm Resistor 1%, 1/16W, 0402	ROHM	MCR01MZPF1000
R29, R31	2	16.5k ohm Resistor 1% 0.1W, 0603	ROHM	MCR03EZPFX1652
R30	1	36.5k ohm Resistor SMD 1%, 0.1W, 0603	ROHM	MCR03EZPFX3652
R38	1	300 ohm Resistor SMD 1%, 1/16W, 0402	ROHM	MCR01MZPF3000
R50	1	52.3k ohm Resistor SMD 1%, 0.1W, 0603	ROHM	MCR03EZPFX5232
R51	1	2.74k ohm Resistor 0603 1%, 0.1W, 0603	ROHM	MCR03EZPFX2741
R52	1	100k ohm Resistor 5%, 1/10W, 0603	ROHM	MCR03EZPJ104
S1, S2, S3, S4, S5, S6	6	Switch, Tactile, SPST w/GND, SMD	Omron Electronics Inc	B3U-1100P
U1	1	AVR 8-bit Microcontroller, 128K, 64QFN	Atmel	AT90USB1287-16MU
U2	1	Regulator, LDO, 300mA, 3.3V, 8MSOP	National Semiconductor	LP3981IMM-3.3/NOPB
U3	1	LMH0307 3G SDI Dual Cable Driver, LLP16	National Semiconductor	LMH0307SQ
X1	1	Crystal, 8.00 MHz , 8 pF, Fund, SMD	NDK	NX5032GA 8MHZ AT-W

# Appendix

Additional typical performance plots measured with the SD303EVK and SD307EVK are provided as reference.

ORL (Output Return Loss) plots are shown for each output.

Eye patterns showing transition times and jitter are shown for 2.97 Gbps. Amplitude measurements are shown for the outputs at 270 Mbps.

Equipment: HP 8722ES Network Analyzer, Agilent DCA-J 86100C Scope, BertScope Digital Synthesis

Conditions: Nominal supply and room temperature, connection cables only

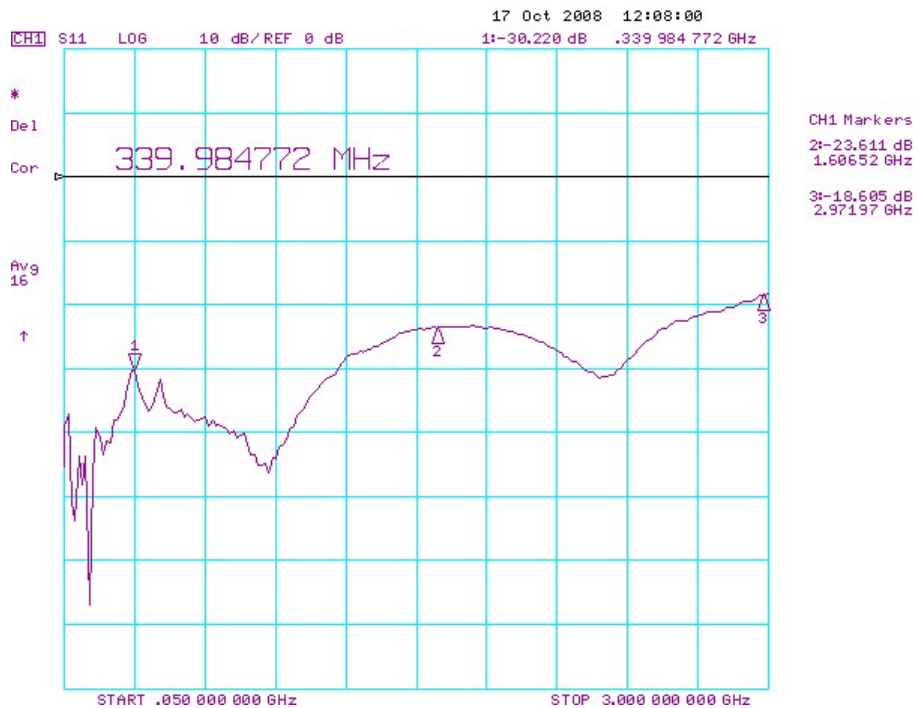

**ORL Plot - Channel 0 – Negative**

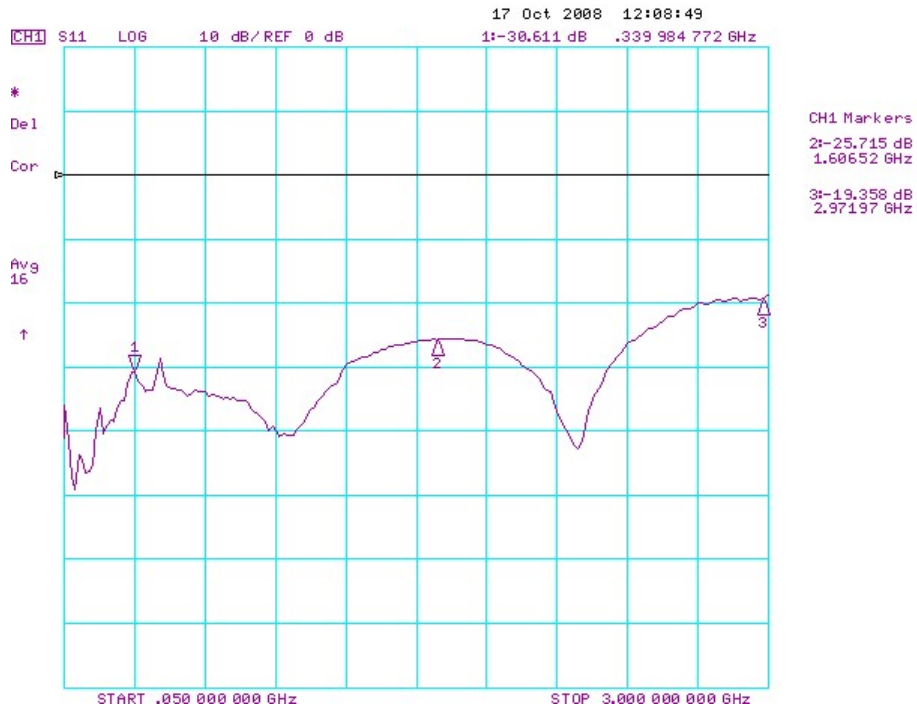

**ORL Plot - Channel 0 – Positive**

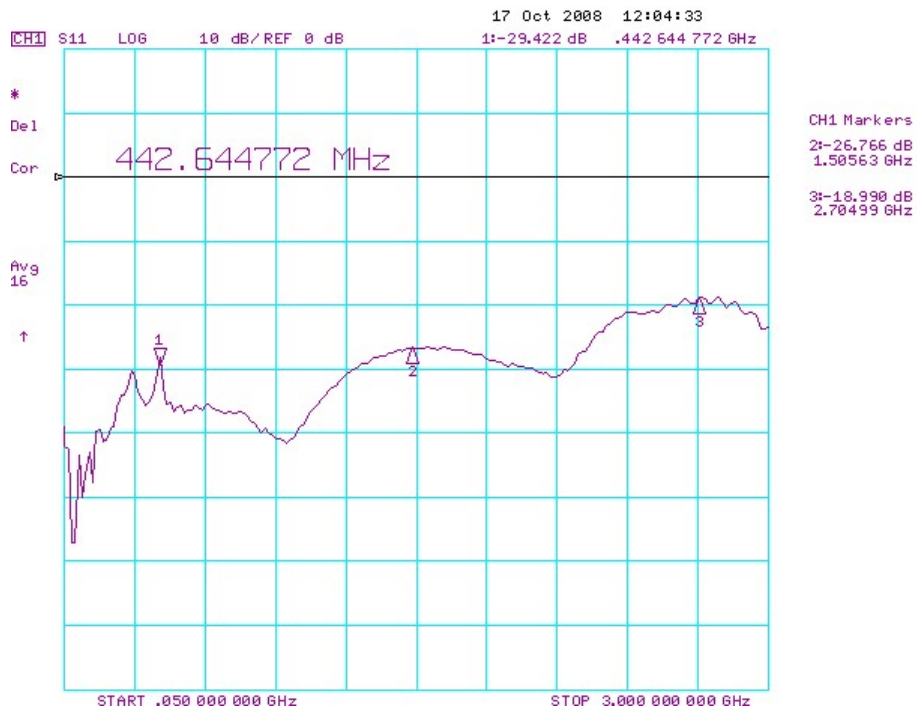

**ORL Plot - Channel 1 – Positive**

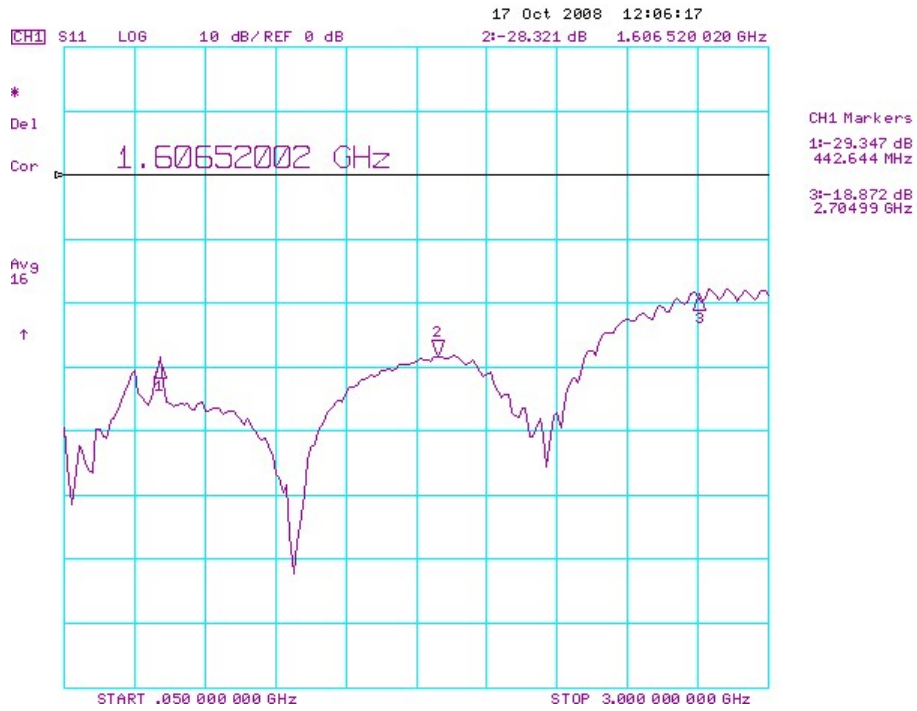

**ORL Plot - Channel 1 – Negative**

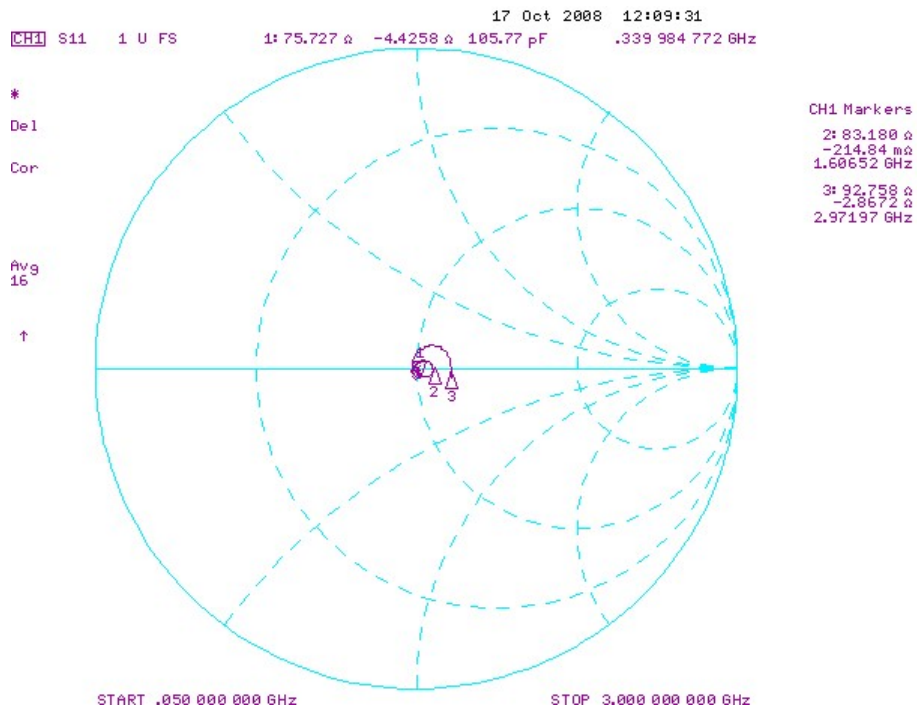

**Smith Chart – Channel 0 – Positive**

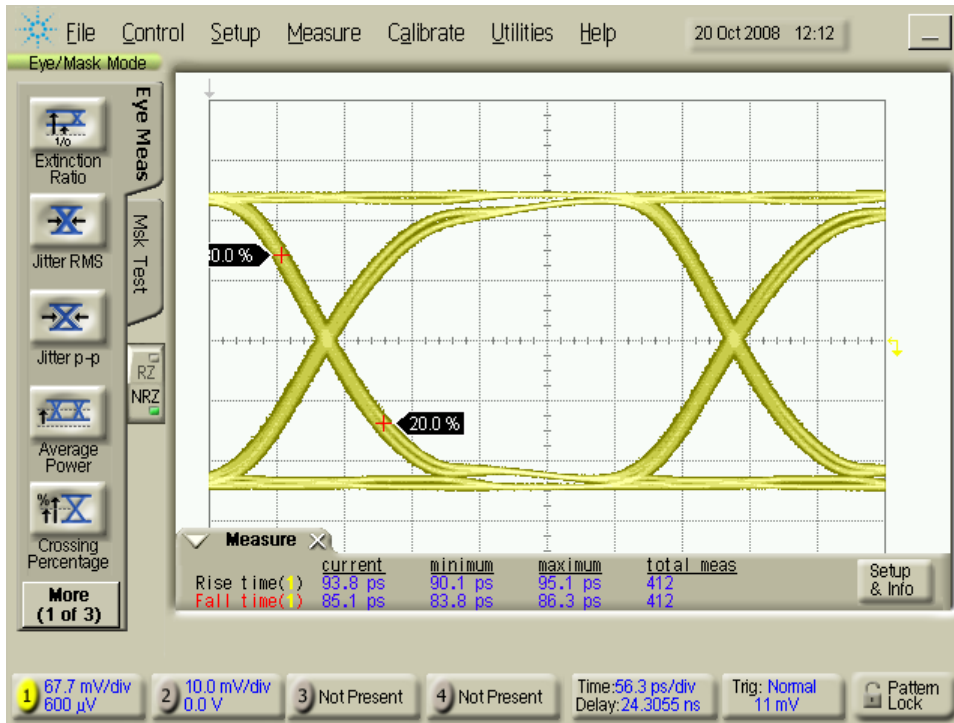

2.97Gbps EYE - Channel 0 – Positive – Transition Times

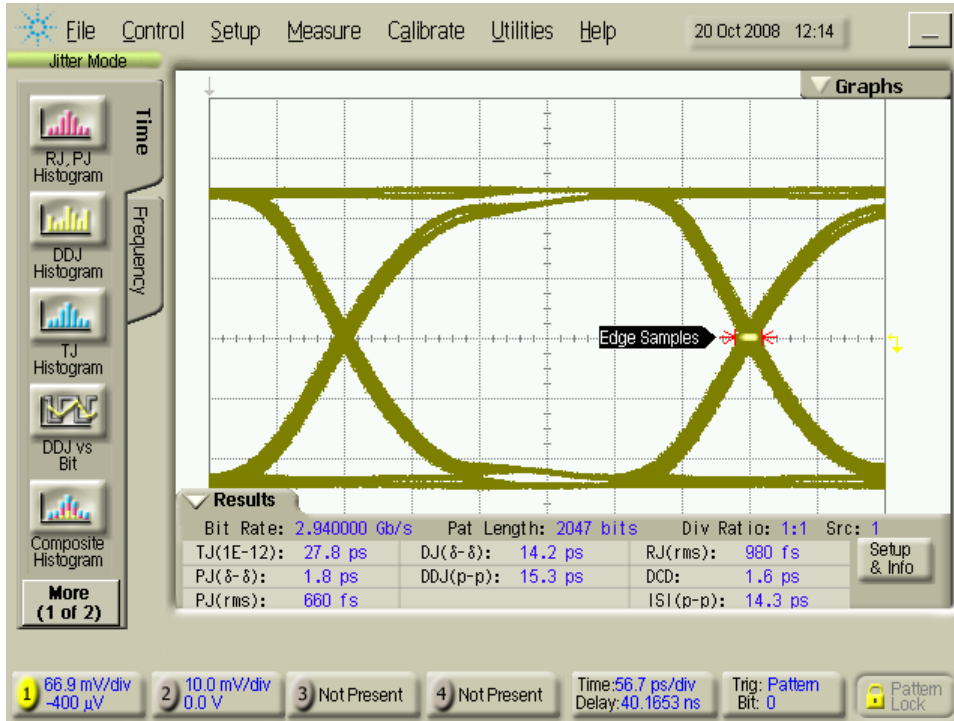

2.97Gbps EYE - Channel 0 – Positive – Jitter

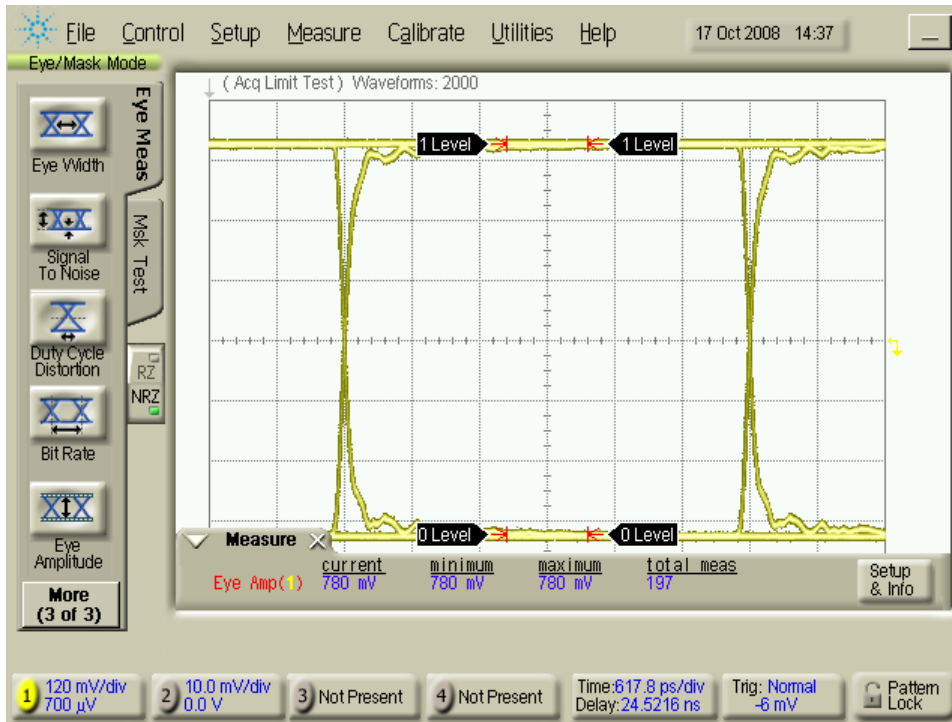

**270 Mbps EYE – Channel 0 – Negative – Color Bar - Amplitude**

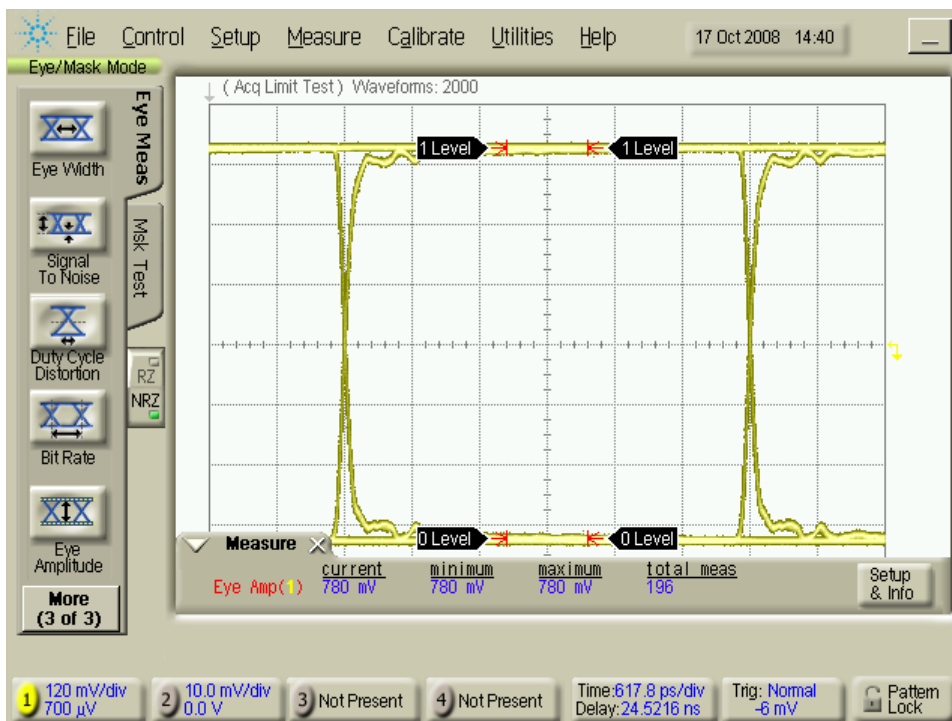

**270 Mbps EYE – Channel 0 – Positive – Color Bar – Amplitude**

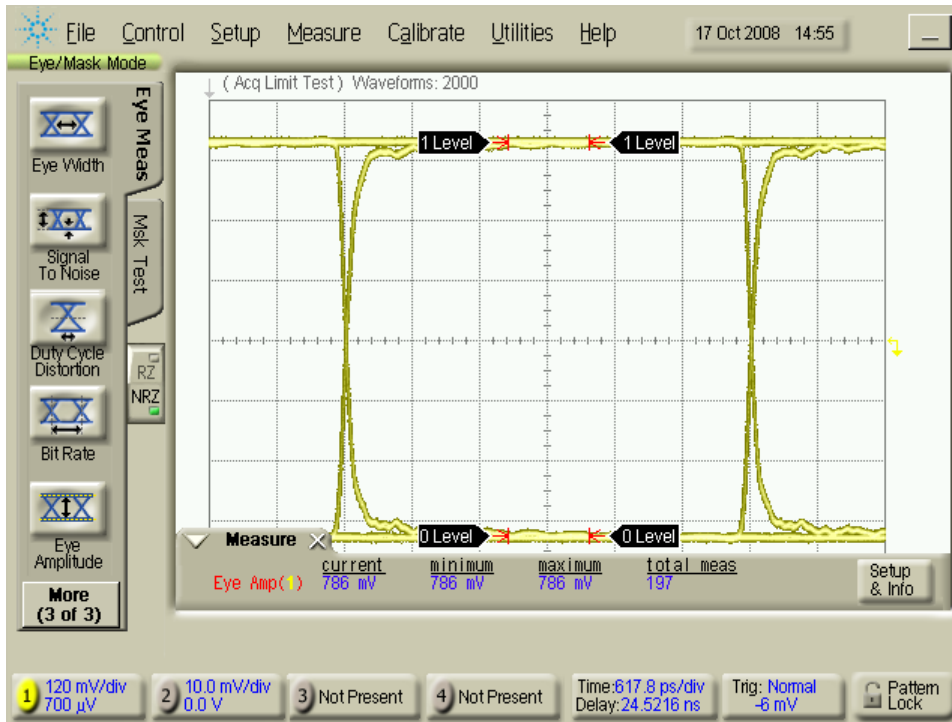

**270 Mbps EYE – Channel 1 – Negative – Color Bar – Amplitude**

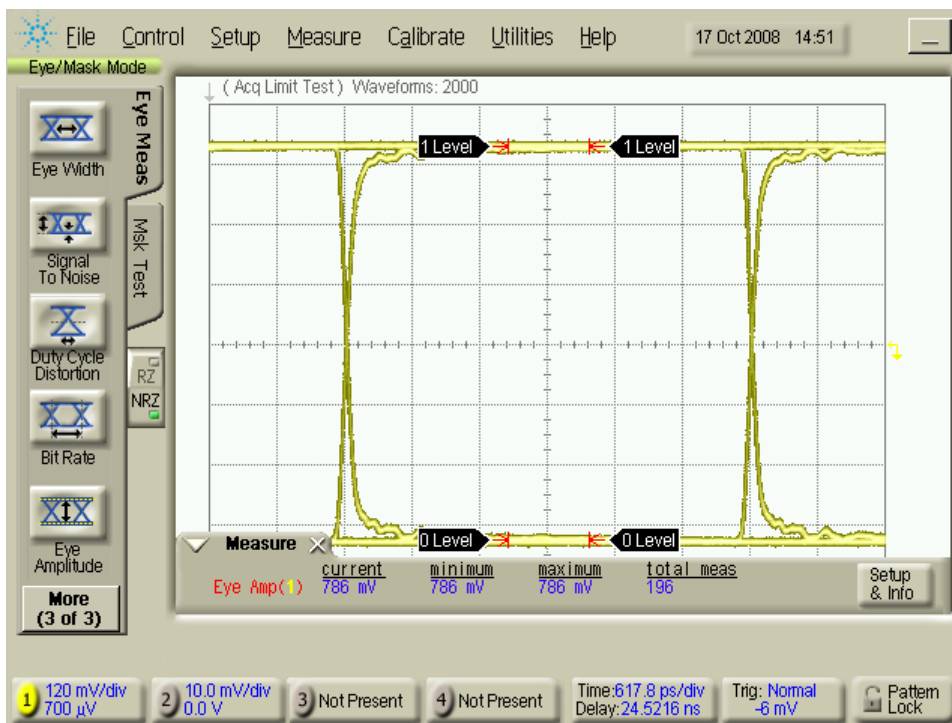

**270 Mbps EYE – Channel 1 – Positive – Color Bar – Amplitude**

## Schematic

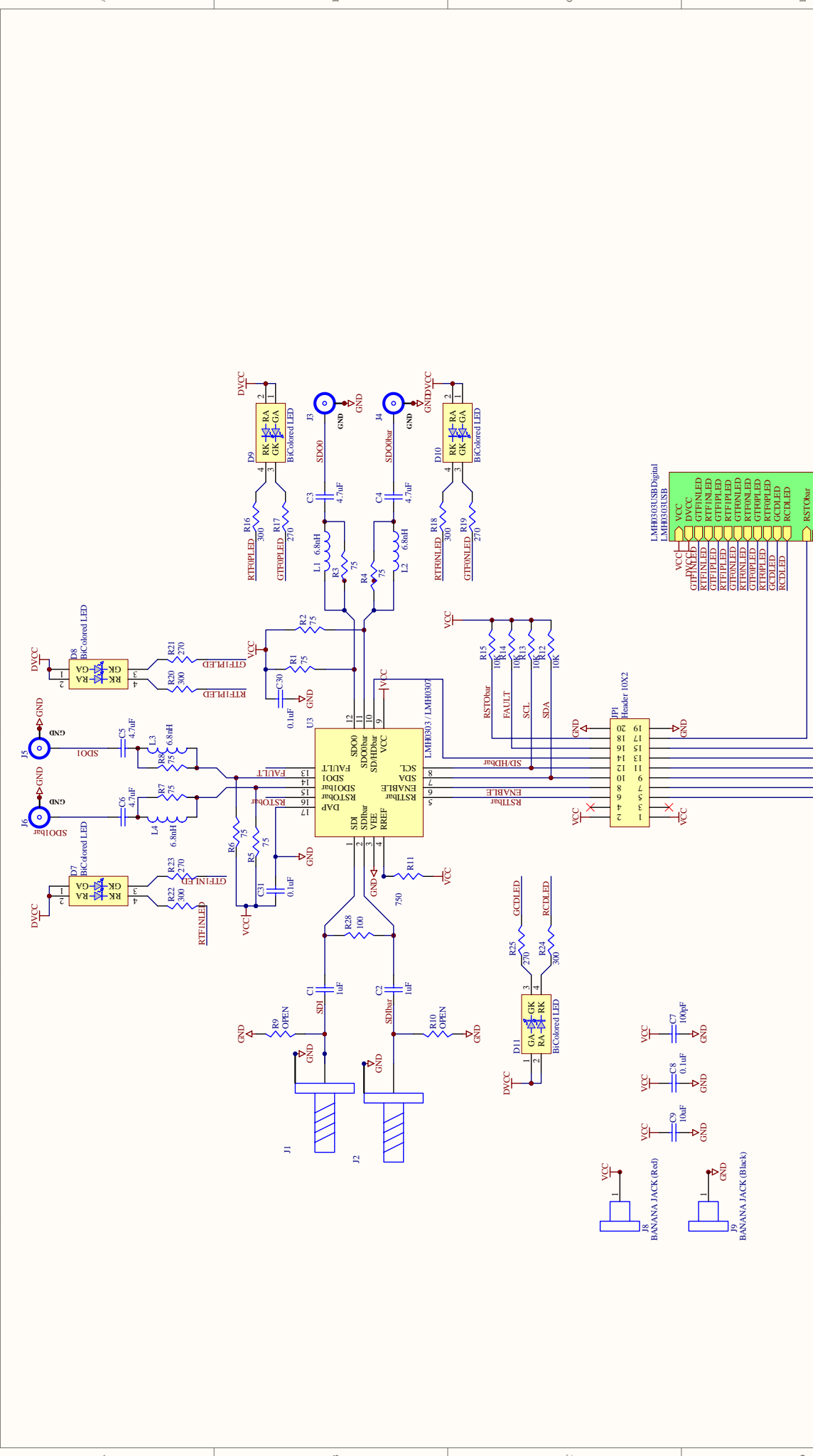

Title		SD303 / SD307 Evaluation Board for the LMH0303 / LMH0307	
Size	Number	Sheet	of
B		1	1
Date:	10/7/2009		
File:	C:\Documents and Settings\... \LMH0303\10042561.dwg		
Revision			

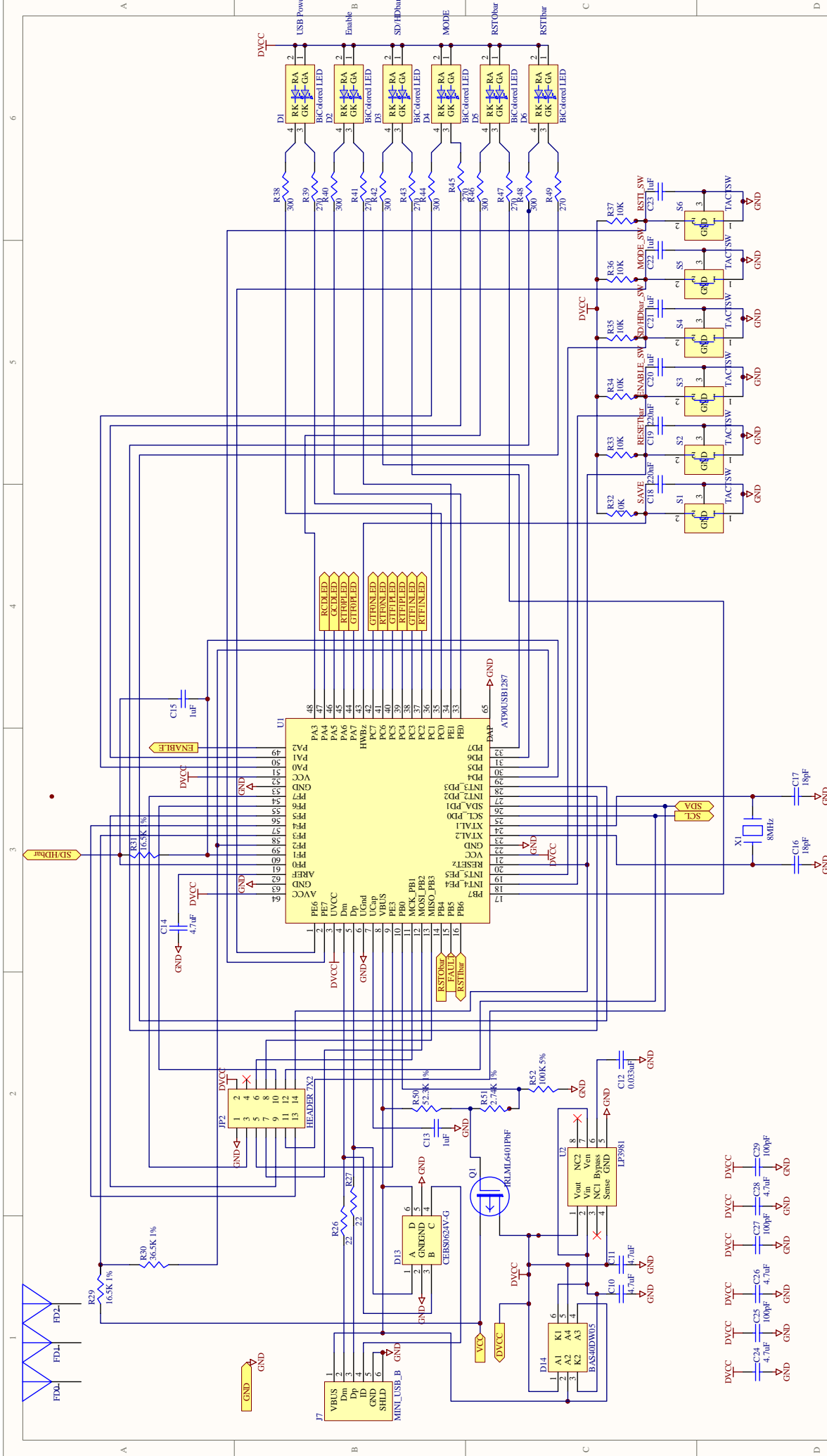

Title		SD303 / SD307 Evaluation Board for the LMH0303 / LMH0307	
Size	Number	Revision	
B			
Date:	2/12/2010	Sheet	of
File:	C:\Documents and Settings\... \LMH0303\1\BIB6409.C		

## IMPORTANT NOTICE

Texas Instruments Incorporated and its subsidiaries (TI) reserve the right to make corrections, modifications, enhancements, improvements, and other changes to its products and services at any time and to discontinue any product or service without notice. Customers should obtain the latest relevant information before placing orders and should verify that such information is current and complete. All products are sold subject to TI's terms and conditions of sale supplied at the time of order acknowledgment.

TI warrants performance of its hardware products to the specifications applicable at the time of sale in accordance with TI's standard warranty. Testing and other quality control techniques are used to the extent TI deems necessary to support this warranty. Except where mandated by government requirements, testing of all parameters of each product is not necessarily performed.

TI assumes no liability for applications assistance or customer product design. Customers are responsible for their products and applications using TI components. To minimize the risks associated with customer products and applications, customers should provide adequate design and operating safeguards.

TI does not warrant or represent that any license, either express or implied, is granted under any TI patent right, copyright, mask work right, or other TI intellectual property right relating to any combination, machine, or process in which TI products or services are used. Information published by TI regarding third-party products or services does not constitute a license from TI to use such products or services or a warranty or endorsement thereof. Use of such information may require a license from a third party under the patents or other intellectual property of the third party, or a license from TI under the patents or other intellectual property of TI.

Reproduction of TI information in TI data books or data sheets is permissible only if reproduction is without alteration and is accompanied by all associated warranties, conditions, limitations, and notices. Reproduction of this information with alteration is an unfair and deceptive business practice. TI is not responsible or liable for such altered documentation. Information of third parties may be subject to additional restrictions.

Resale of TI products or services with statements different from or beyond the parameters stated by TI for that product or service voids all express and any implied warranties for the associated TI product or service and is an unfair and deceptive business practice. TI is not responsible or liable for any such statements.

TI products are not authorized for use in safety-critical applications (such as life support) where a failure of the TI product would reasonably be expected to cause severe personal injury or death, unless officers of the parties have executed an agreement specifically governing such use. Buyers represent that they have all necessary expertise in the safety and regulatory ramifications of their applications, and acknowledge and agree that they are solely responsible for all legal, regulatory and safety-related requirements concerning their products and any use of TI products in such safety-critical applications, notwithstanding any applications-related information or support that may be provided by TI. Further, Buyers must fully indemnify TI and its representatives against any damages arising out of the use of TI products in such safety-critical applications.

TI products are neither designed nor intended for use in military/aerospace applications or environments unless the TI products are specifically designated by TI as military-grade or "enhanced plastic." Only products designated by TI as military-grade meet military specifications. Buyers acknowledge and agree that any such use of TI products which TI has not designated as military-grade is solely at the Buyer's risk, and that they are solely responsible for compliance with all legal and regulatory requirements in connection with such use.

TI products are neither designed nor intended for use in automotive applications or environments unless the specific TI products are designated by TI as compliant with ISO/TS 16949 requirements. Buyers acknowledge and agree that, if they use any non-designated products in automotive applications, TI will not be responsible for any failure to meet such requirements.

Following are URLs where you can obtain information on other Texas Instruments products and application solutions:

### Products

Audio	<a href="http://www.ti.com/audio">www.ti.com/audio</a>
Amplifiers	<a href="http://amplifier.ti.com">amplifier.ti.com</a>
Data Converters	<a href="http://dataconverter.ti.com">dataconverter.ti.com</a>
DLP® Products	<a href="http://www.dlp.com">www.dlp.com</a>
DSP	<a href="http://dsp.ti.com">dsp.ti.com</a>
Clocks and Timers	<a href="http://www.ti.com/clocks">www.ti.com/clocks</a>
Interface	<a href="http://interface.ti.com">interface.ti.com</a>
Logic	<a href="http://logic.ti.com">logic.ti.com</a>
Power Mgmt	<a href="http://power.ti.com">power.ti.com</a>
Microcontrollers	<a href="http://microcontroller.ti.com">microcontroller.ti.com</a>
RFID	<a href="http://www.ti-rfid.com">www.ti-rfid.com</a>
OMAP Mobile Processors	<a href="http://www.ti.com/omap">www.ti.com/omap</a>
Wireless Connectivity	<a href="http://www.ti.com/wirelessconnectivity">www.ti.com/wirelessconnectivity</a>

### Applications

Automotive and Transportation	<a href="http://www.ti.com/automotive">www.ti.com/automotive</a>
Communications and Telecom	<a href="http://www.ti.com/communications">www.ti.com/communications</a>
Computers and Peripherals	<a href="http://www.ti.com/computers">www.ti.com/computers</a>
Consumer Electronics	<a href="http://www.ti.com/consumer-apps">www.ti.com/consumer-apps</a>
Energy and Lighting	<a href="http://www.ti.com/energy">www.ti.com/energy</a>
Industrial	<a href="http://www.ti.com/industrial">www.ti.com/industrial</a>
Medical	<a href="http://www.ti.com/medical">www.ti.com/medical</a>
Security	<a href="http://www.ti.com/security">www.ti.com/security</a>
Space, Avionics and Defense	<a href="http://www.ti.com/space-avionics-defense">www.ti.com/space-avionics-defense</a>
Video and Imaging	<a href="http://www.ti.com/video">www.ti.com/video</a>

TI E2E Community Home Page

[e2e.ti.com](http://e2e.ti.com)

Mailing Address: Texas Instruments, Post Office Box 655303, Dallas, Texas 75265  
Copyright © 2012, Texas Instruments Incorporated

## Looking for pricing, stock, or lifecycle information?

Click below to explore more details on WIN SOURCE:

 [View SD303EVK](#) on WIN SOURCE

 [Texas Instruments](#) Information

## Optimize Your Supply Chain with WIN SOURCE Solutions

-  Global Sourcing Solution
-  Obsolete Management
-  Cost Control Management
-  Shortage Management
-  Alternative Solution
-  Excess Inventory Management