



THE DATASHEET OF SPEEDTOGOKITTOB01



TLE4922 User Manual

Cost Efficient Hall Effect Sensor

About this document

This document is the User Manual of TLE4922, cost efficient Hall effect speed sensor.

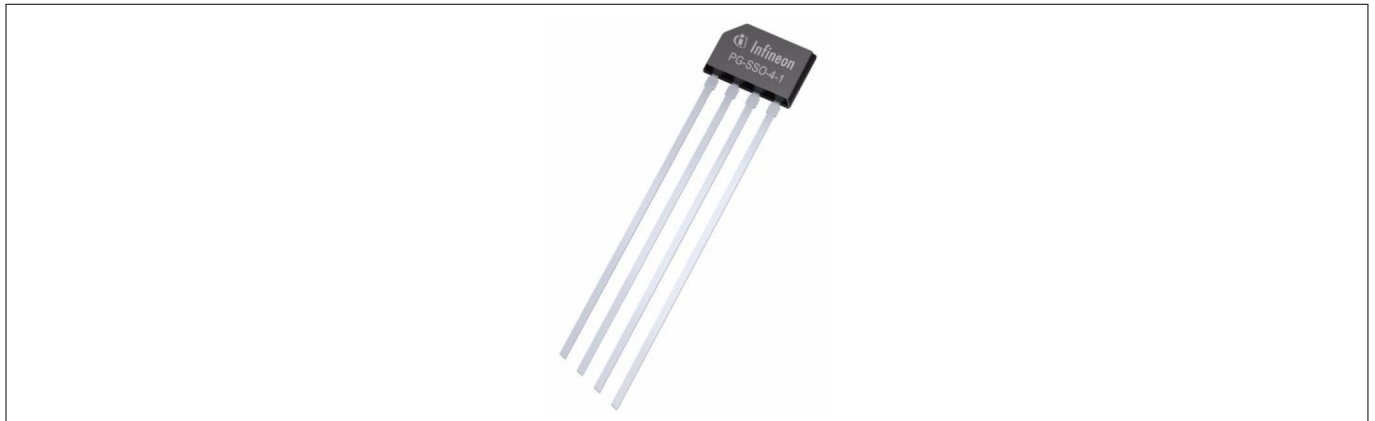

Figure 1 **TLE4922**

Scope and purpose

This User Manual compares active and passive speed sensors, focusing on the main application parameters. It provides recommendations with regards to mechanical and magnetical setup, information about customer interface and evaluation / mapping tools. Finally Frequently Asked Questions are answered at the end of the document. For further product information please refer to the TLE4922 product data sheet.

Intended audience

This User Manual is for engineers working with the TLE4922 sensor.

Table of contents

Table of contents

	About this document	1
	Table of contents	2
1	Comparison Hall versus VR	4
1.1	Passive Sensors	4
1.2	Active Sensors	5
1.3	Principle and basic operation of different speed sensing technologies	6
1.3.1	Variable reluctance sensor	6
1.3.2	Hall sensor	7
1.4	Comparison of active and passive sensors based on application parameters	8
1.4.1	Air gap performance	9
1.4.2	Zero speed and true power on function	11
1.4.3	Reference zone	12
1.4.4	Jitter (repeatability of a tooth revolution by revolution)	12
1.4.5	Electromagnetic compatibility (EMC), output signal and signal conditioning	13
1.4.6	Module size, module weight and mounting considerations	14
1.4.7	Direction detection and vibration detection	14
2	Consideration in magnetic circuit design	16
2.1	Mechanical setup	16
2.2	Magnetical setup	17
2.3	Tracking algorithm of TLE4922, Offset-update	18
2.4	Flux concentration on toothed wheel, strong back bias magnet and small operational air gap ..	19
3	Customer Interface	21
3.1	Serial Inspection and Configuration Interface (SICI)	21
3.2	SICI protocol	22
3.3	Test modes activation	23
3.4	Command codes	24
4	Evaluation Kit / Mapping Tool	25
4.1	“TLE4922 MS2GO” - Hardware	25
4.2	“TLE4922 MS2GO” - Software	26
4.3	iMAT - Speed Viewer	28
5	Frequently asked questions	29
5.1	What is the working principle of TLE4922? Can you explain the blockdiagram?	29
5.2	Can you give me some details on start up behaviour and calibrated mode? How many magnetic edges are needed for stable operation?	32
5.3	How does the hidden adaptive hysteresis concept work?	34
5.4	What is the minimum air gap?	35
5.5	What types of magnets can be used?	35
5.6	What is the reset voltage of TLE4922?	35

Table of contents

5.7	Can TLE4922 be used together with a magnetic encoder wheel?	36
6	Revision History	37
	Disclaimer	38

1 Comparison Hall versus VR

1 Comparison Hall versus VR

For automotive speed sensing mainly magnetic sensors are used due to their robustness against harsh environmental conditions. Choosing magnetic sensors nearly eliminates speed measurement impediments, such as friction, light or contaminants. In general, two different principles are used: passive and active magnetic sensors.

1.1 Passive Sensors

A typical passive magnetic sensor is the variable reluctance sensor (VR Sensor) which is shown in [Figure 2](#) in front of a passive encoder (ferro magnetic tooth wheel).

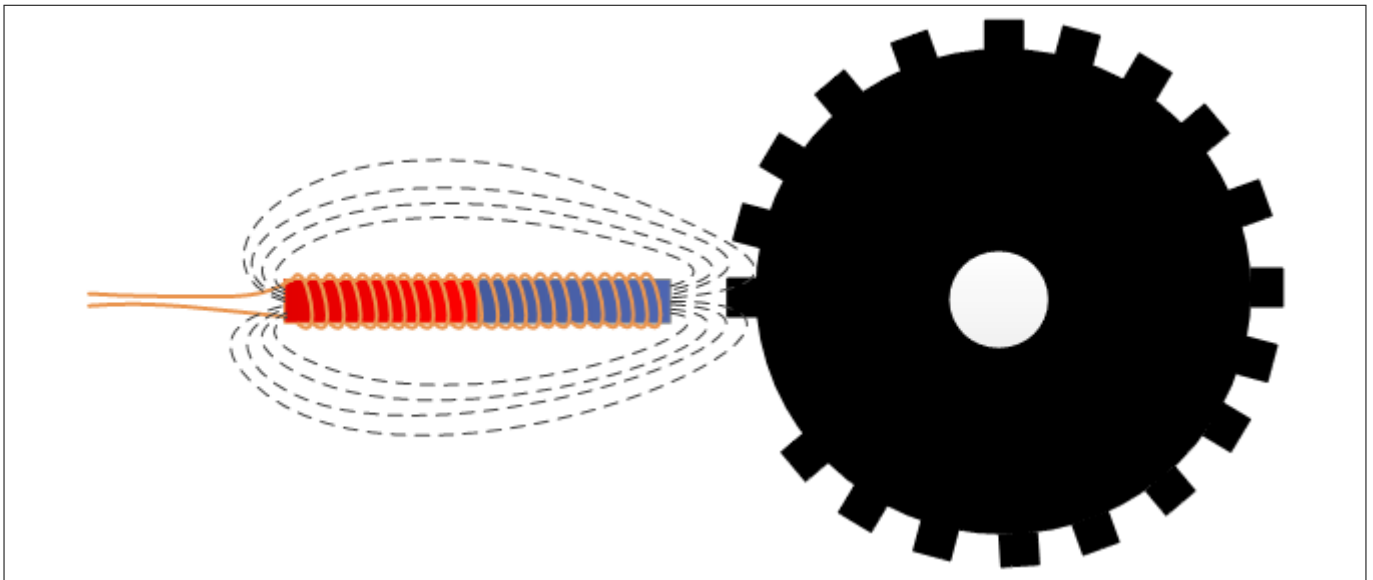

Figure 2 Basic scheme of sensing-principle of a VR-sensor

Variable reluctance sensors (VRS) are built of a small magnet in shape of a stick. Around this stick there are several windings of copper. When the magnetic flux changes due to the movement of the toothed wheel, a voltage is induced according to Faraday's law ([Equation 1](#)).

$$\epsilon = - \frac{d\phi}{dt}$$

Equation 1 Equation on the magnetic flux

Where ϵ is the electromotive force and ϕ the magnetic flux.

While the wheel is turning, the teeth of the toothed wheel create a sinusoidal output signal as shown in [Figure 3](#).

1 Comparison Hall versus VR

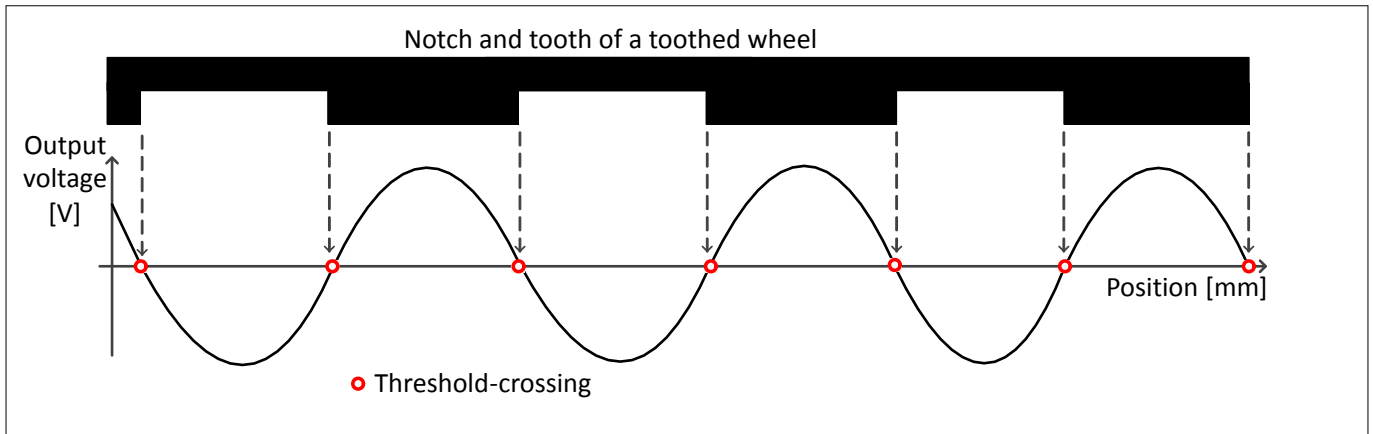

Figure 3 Toothed wheel mapped into Voltage

If the tooth is in front of the sensor, the magnetic flux increases. If a notch is in front of the VR sensor, the magnetic flux decreases. According to the equation 1, a proportional output voltage is produced on changing the flux over time.

1.2 Active Sensors

Active Sensor produces a digital output proportional to the magnitude of flux, not related to the rate of change of flux. There are several magnetic principles that can be used by active sensors such as

- Hall-Effect
- Anisotropic magneto resistance (AMR) Effect
- Giant magneto resistance (GMR) Effect
- Tunnel magneto resistance (TMR) Effect

Among all these active speed sensing technologies mentioned above, Hall effect is the most mature technology.

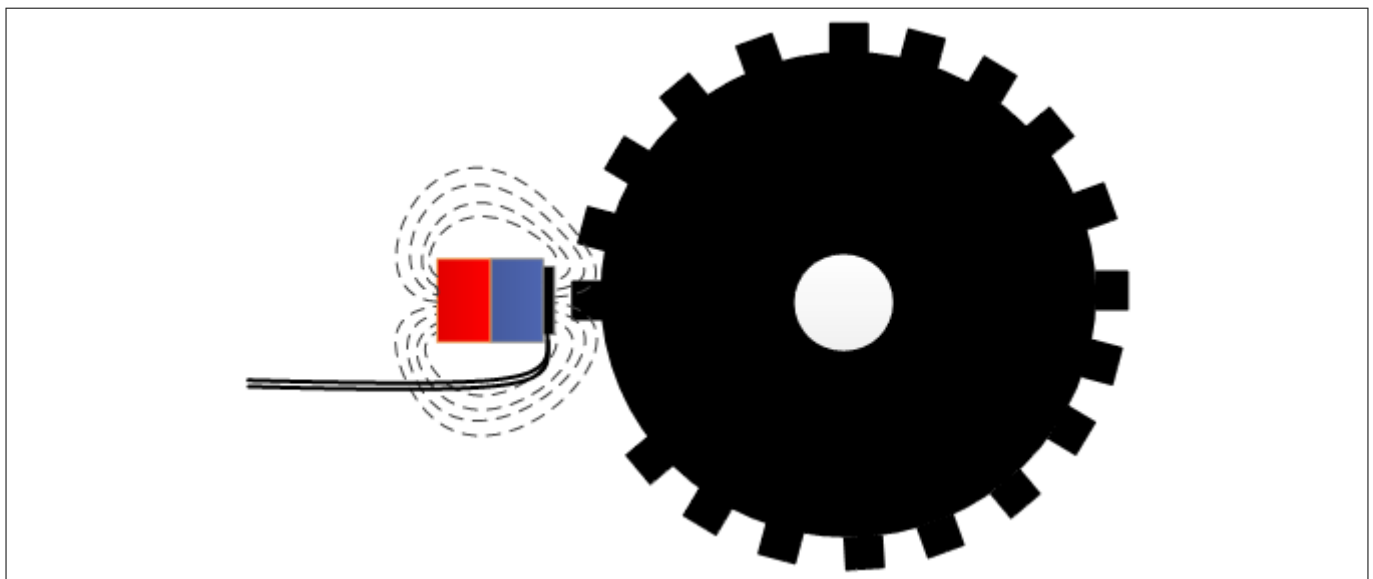

Figure 4 Basic scheme of sensing-principle of a Hall-sensor

A commonly used set up is shown in [Figure 4](#). A small magnet named as Back-bias magnet is placed behind the sensor to create the flux required for its operation. With the same principle as described in passive sensors, the magnetic flux is deviated by the teeth of the moving wheel. The difference is in the sensing principle: Hall- and

1 Comparison Hall versus VR

xMR-effect is sensing the value of flux and not the rate of change of flux. Therefore active sensors can sense even a stationary wheel. The principle of the back-biasing can also be used on wheel-biasing:

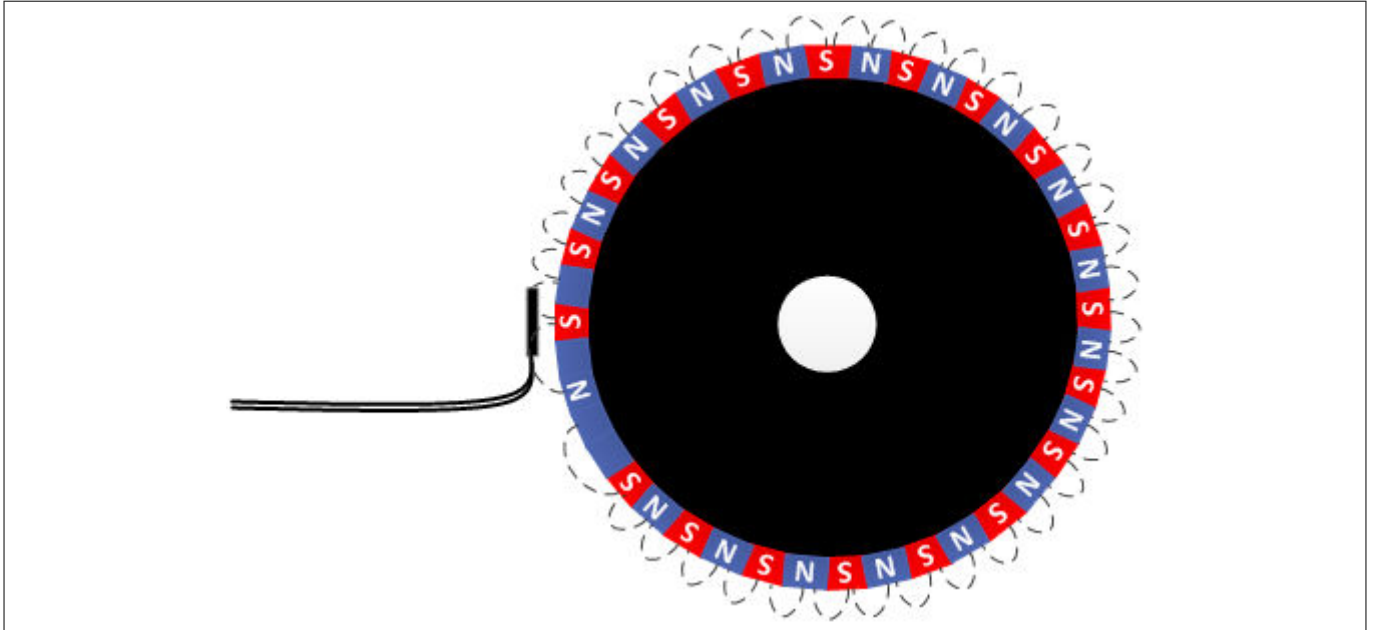

Figure 5 Basic scheme of sensing-principle of a Hall-sensor on a magnetic encoder wheel

A multi-pole-wheel (also named magnetic encoder) has a multiple number of pole-pairs mounted one after the other on the circumference of the wheel. Using this type of wheel makes the use of a back bias magnet redundant. The alternating magnetic field is produced by the wheel itself.

1.3 Principle and basic operation of different speed sensing technologies

Sensing concept is dealt more in detail in this section for further comparison. The main difference is active sensing like Hall or xMR-technology versus passive sensing based on a coil and the need of movement in the system.

1.3.1 Variable reluctance sensor

The nature of a passive sensor makes the VR sensor very robust in harsh environments. Since there is no need of an external power-supply, the sensor is robust against external electrical distortion. Different types of VR sensors are available in market with different source resistance values, number of windings and types of wires used.

The output voltage of a VR-sensor can range from only a few Millivolts going up to several hundreds of Volts depending on air gap and tooth-frequency in front of the sensor. As can be seen in [Figure 6](#), the air-gap is the distance from the toothed wheel to the surface of the sensor. Typical application air-gap is between 1mm and 2mm.

1 Comparison Hall versus VR

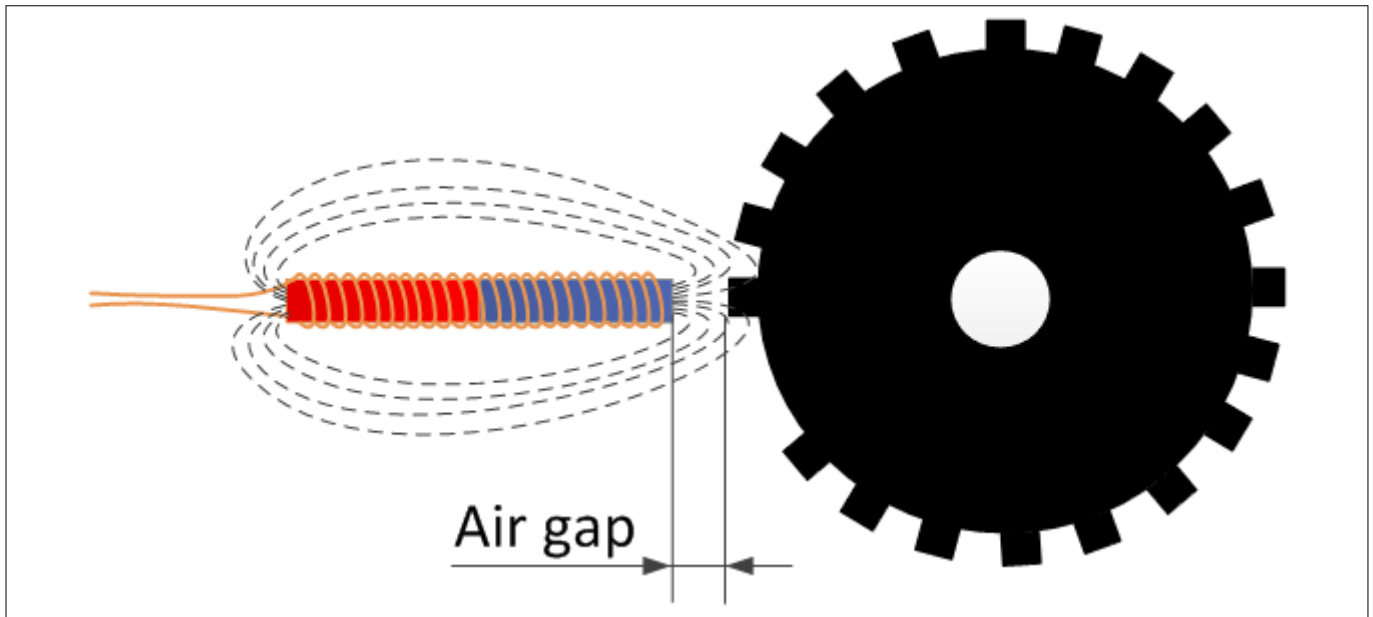

Figure 6 Definition of air gap

Further Interfacing of a VR sensor with a controller is only possible after the signal conditioning of its analog input. Signals as low as 1mV have to be amplified to a TTL (transistor-transistor logic) signal level and signals up to 400V have to be clipped to ensure safe and efficient operation of the controller input stage/phase. Standard interface IC's have a clipping input, a low-pass filtering, an adaptive amplifier and an adaptive comparator to condition the output for further usage/application together with a micro controller.

1.3.2 Hall sensor

The Hall sensor is an active system which has normally one of the following types of output:

- Open drain output which allows the ECU to choose high-voltage independent of the sensor
- Current interface which allows the manufacturer to have the same amount of wires as the VR-system: 2 wires

The signal itself is captured and amplified with less than 1mm of distance since signal conditioning is present on the silicon itself thereby providing good SNR (signal to noise ratio). Doing sensing and processing the signal at the minimum distance no electrical or magnetical noise can disturb. In one silicon area, the following features can also be achieved (detailed explanation on the following pages):

- Voltage-regulation for electrical biasing of sensing element
- Generating regulated small voltages for digital and analogue supply
- Covering a reset-circuit to guarantee proper functionality
- Including the sensing elements
- Signal amplification
- Cancellation of electrical and magnetic offset using digital or analog circuit
- Monitoring and adjusting hysteresis automatically
- Providing status information in addition to the switching information

The block diagram in [Figure 14](#) describes the main functions of a hall-sensor. Due to the high integration on silicon, it is even possible to place two or three sensing-elements to get rid of common-mode disturbances or just to provide a direction-information of the rotating wheel. The feature is currently limited to the high-end sensors because of increased manufacturing costs.

1 Comparison Hall versus VR

1.4 Comparison of active and passive sensors based on application parameters

An application is mostly defined by the passive encoder (Ferromagnetic wheel) and its geometry. This wheel has tolerances in diameter, width, tooth-height, tooth-width, and of course, its eccentricity referred to as run-out. These parameters are not directly related to the two sensing technologies, but have to be dealt with by the sensor. To find the best sensor for a specific application, several parameters have to be taken into consideration. In this section, the comparison of the two different sensing technologies is carried out based on the system-test-bench results. The passive system (VR-sensor) is called VR and has a signal-conditioning circuit as shown in **Figure 7**. Furthermore there were two types of Hall-sensors part of this comparison named Hall1 and Hall2 from different suppliers..

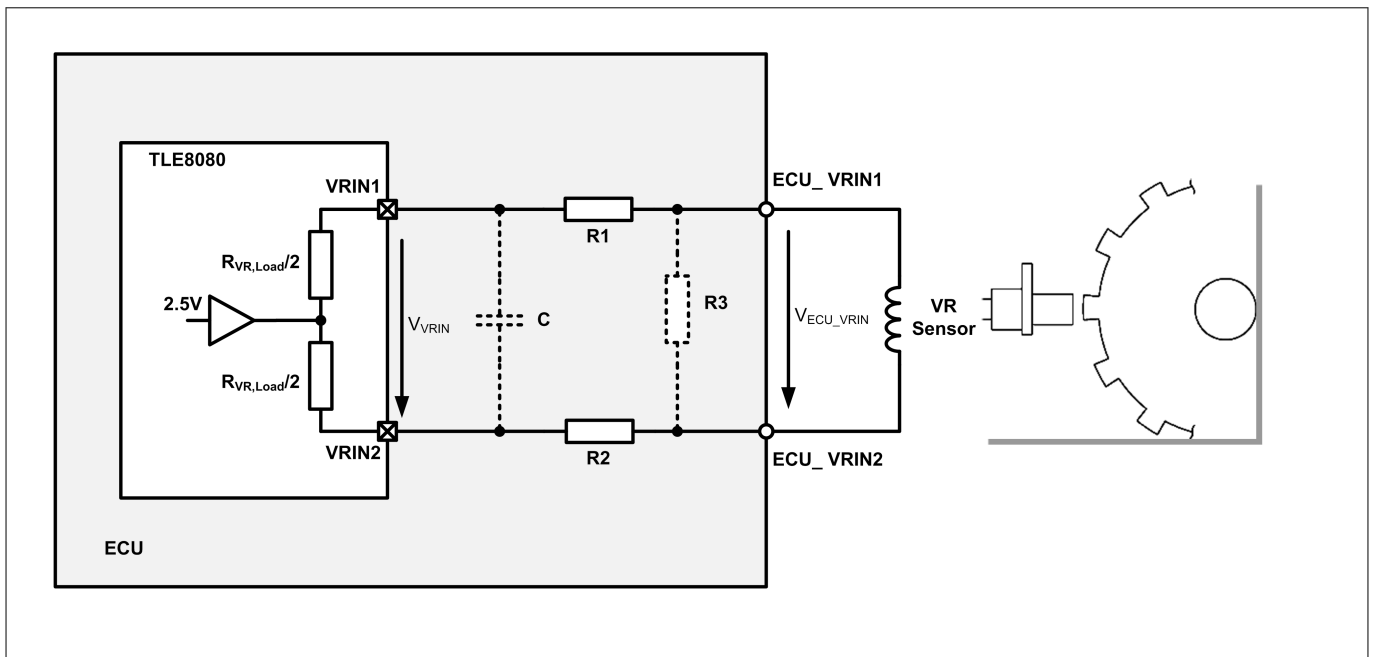

Figure 7 VR Sensor application circuit with integrated interface IC

1 Comparison Hall versus VR

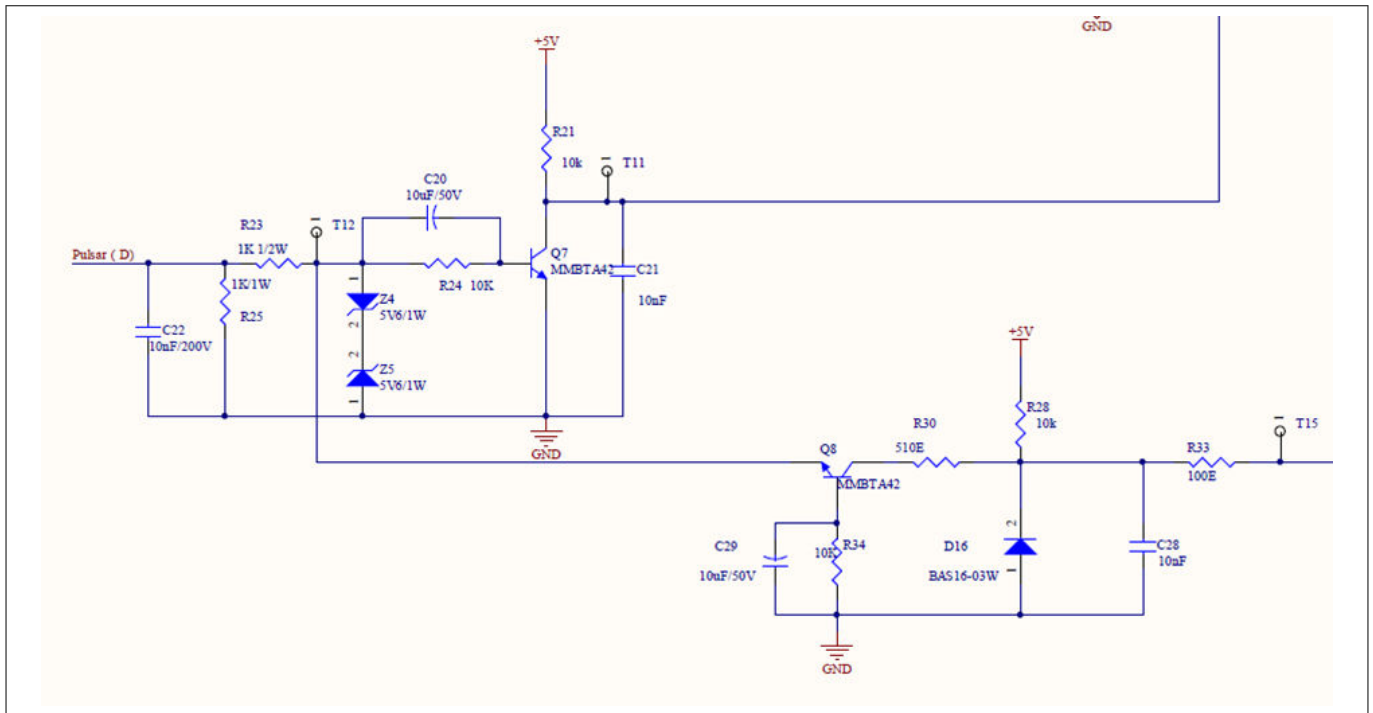

Figure 8 VR Sensor application circuit with discrete components

The alternative circuit beside an integrated VR-Interface is using some discrete circuit as shown in **Figure 8** using about 15 active and passive electronic devices to generate two accurate falling edges on the two transmitting-lines out of the VR-Sensor that is connected to the node “Pulsar (D)”. This is some effort and this is also source of failure, using a piece of printed circuit board (pcb) and a bunch of active and passive components.

System testbench:

The active sensors are supplied with 5V on Vdd and have a pull-up resistor of 1200 ohms to Vdd. For both sensors, a data acquisition system from National Instruments (PXI System) consisting of an analogue front end (which is a comparator switching at 2.5V) is employed. This signal is fed into a FPGA (Field Programmable Gate Array) clocked at 200MHz) for further processing and time-stamps are captured with a resolution of 20ns. The second input of the FPGA is fed by a high-precision encoder generating 40.000 pulses per revolution. Using this encoder the FPGA calculates the rotating angle of the wheel with an accuracy of 0.009°. The timestamps of the sensor (falling edge) and the angle of the wheel are post processed and the parameters like air-gap and jitter are calculated once sufficient data is captured.

1.4.1 Air gap performance

The manufacturer of an engine, a transmission or a complete vehicle should be able to position the sensor with a certain tolerance in front of the toothed wheel. Adding the tolerances of the wheel and its mounting, typical air-gaps of 1mm to 2mm can be achieved. The strength of the magnet used in the system (either magnet stick or back bias magnet) influences the optimal air-gap. The sensor should be capable of generating a good signal under all circumstances of air-gap and temperature. In **Figure 9** a VR-sensor can be seen at this position waiting for the air-gap measurement to start.

1 Comparison Hall versus VR

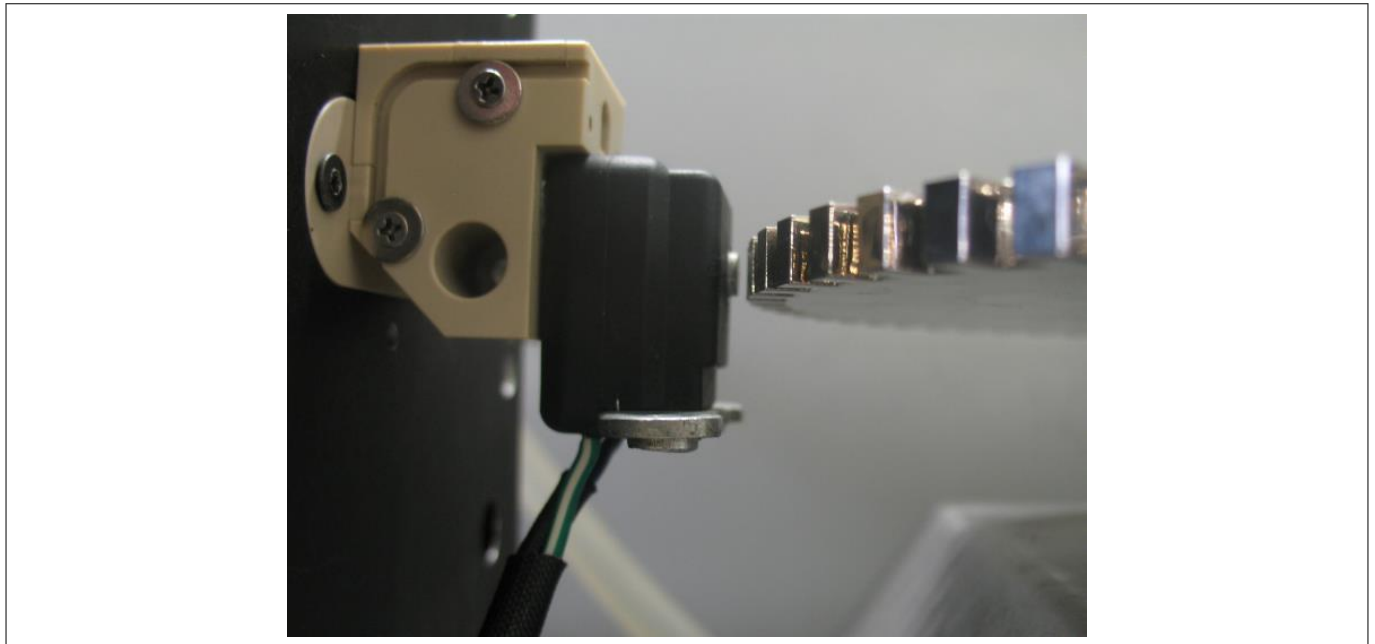

Figure 9 VR Sensor in front of a toothed wheel

For comparison typical frequencies were used: For starting the engine a low frequency like 100rpm is suitable. The frequency-range is up to 8000rpm. But a more likely rotation speed is 1000rpm.

- 100 rpm for starting behaviour of the engine
- 1000 rpm to represent rotational speeds in typical applications

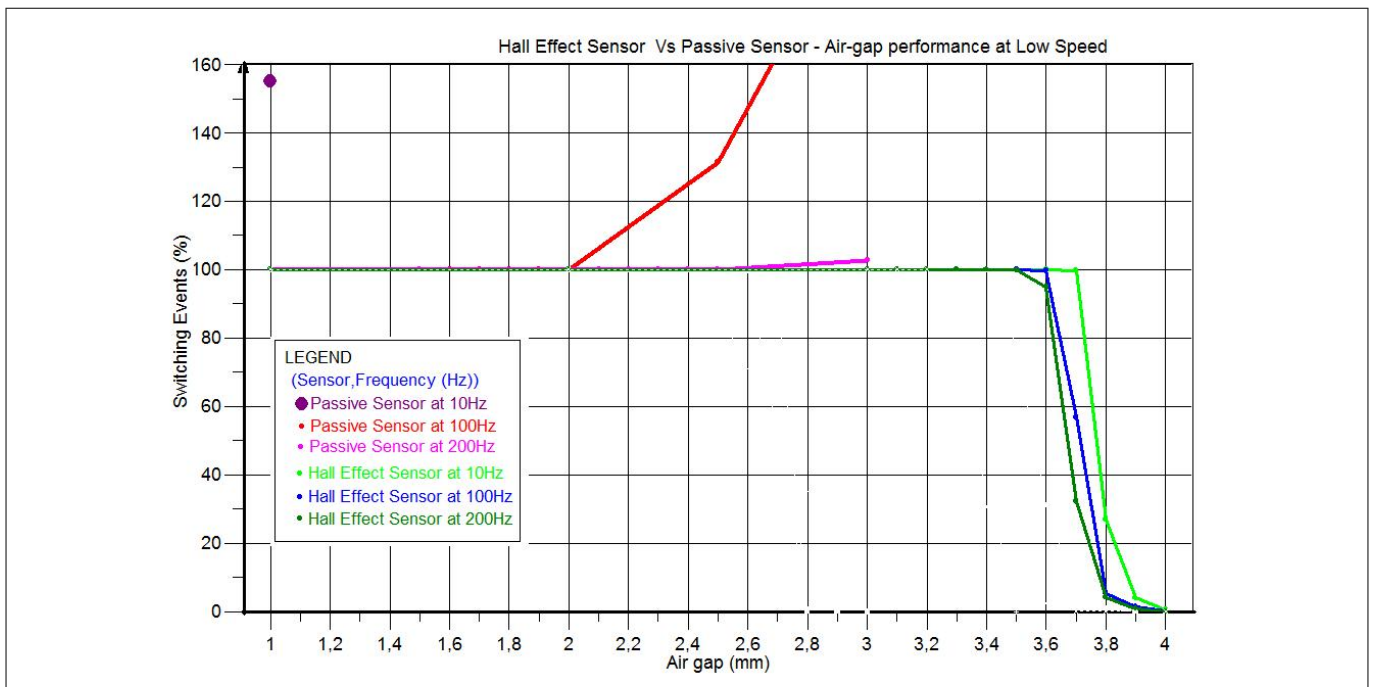

Figure 10 Air-gap performance at low rotational speed: Y-axis indicates the amount of recognized pulses for one revolution

In **Figure 10** a good performance of active sensors compared to a bad performance of the passive system was measured. The reason is the low magnetic flux at the high air-gap. At low frequencies, the passive sensor already fails at a very small air-gap (around 1mm). This limits the manufacturer in terms of mechanical tolerances.

1 Comparison Hall versus VR

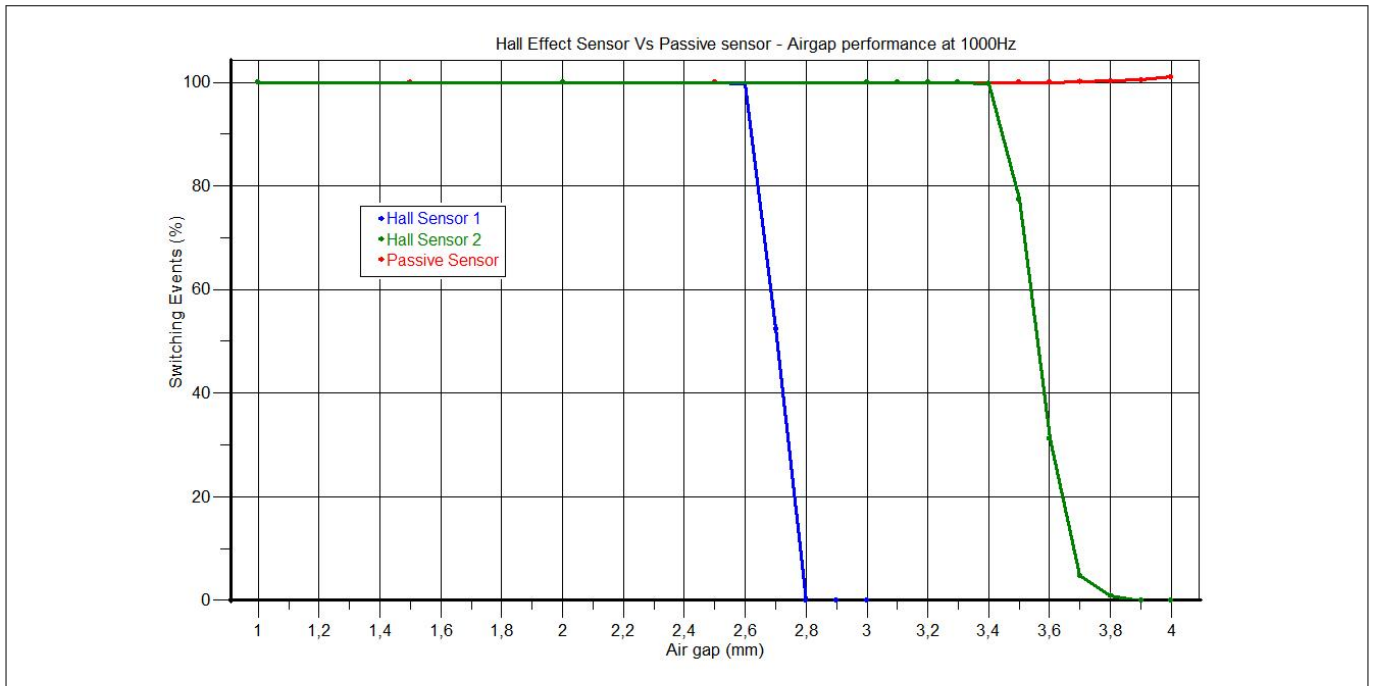

Figure 11 Air-gap performance at medium rotational speed

At medium rotational speed like 1000rpm (as shown in [Figure 11](#)) the performance of the three systems is comparable. Still there are differences between manufacturer in air-gap as can be seen from 2.8mm to 3.8mm (TLE4922) on this specific wheel. The active sensors are aware of the noise and stop working at large air gaps whereas the signal conditioning circuit of the passive sensor tries to detect still some teeth and introduces additional pulses.

1.4.2 Zero speed and true power on function

Zero speed is needed when the vehicle is in stop-start mode and the engine is down. The resulting frequency-range of a sensor capable of stop-start-mode is 0Hz (0rpm) up to 8kHz (8000rpm on a 60-2 teeth crankshaft target wheel). The sensor should be capable of generating a good signal under all circumstances. A missing pulse or an additional pulse is not allowed. True power on capability is often used in camshaft-sensing know immediately at power on the position of the valves.

One further application is autonomous driving and parking where sensing the wheel speed and sensing the transmission speed is needed at a rotational speed of less then 1 tooth per second. The feature of zero speed is used in ABS-application as well as in transmission-application for the hill-holder-functionality.

By concept of sensing, only hall-sensors are able to detect a tooth or a notch already at zero speed. Variable reluctance has the need of moving ferromagnetic parts to get a signal at all. Since modern concepts include stop-start-functionality as well as correct and adjustable valve-setting right at the start of the engine. Demand for this functionality is increasing day by day. This is a clear advantage of active sensors since these sensors work also fine at 1Hz. The operating range of VR-sensors is dependent on the air-gap. When the application allows to go for less than 1mm of air-gap a frequency range of 100Hz up to 20kHz can be achieved.

Active Sensors outperforms passive counterpart over the first three frequency decades as shown in the [Table 1](#)

Table 1 Frequency-behavior of VR-sensors compared to Hall-sensor

Tooth-frequency	DC	1Hz	10Hz	100Hz	1kHz	10kHz
VR-sensor	FAIL	FAIL	FAIL	acceptable	PASS	PASS
Hall-sensor	PASS	PASS	PASS	PASS	PASS	PASS

1 Comparison Hall versus VR

1.4.3 Reference zone

Standard crankshaft wheels do have a reference zone to enable the ECU (Engine Control Unit) to detect the zero-position of the engine. This means they have typically 60 teeth where two consecutive teeth are missing. The sensor should recognize this without influencing other operating parameters. The magnetic signal behaves in the way as illustrated in [Figure 12](#).

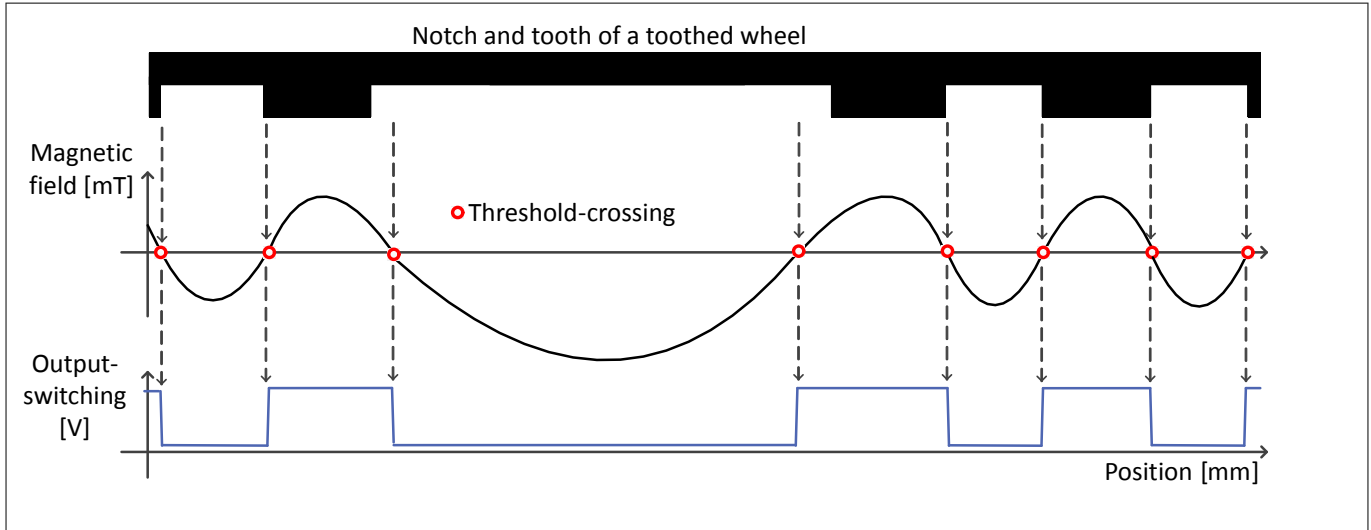

Figure 12 Magnetic signal during a reference zone

The active sensor has implemented computational power for processing of the magnetic signal difference in amplitude and even calculates asymmetric teeth. Passive sensors employ external filters to achieve at least a switching point somewhere in the middle of the magnetic signal.

1.4.4 Jitter (repeatability of a tooth revolution by revolution)

The accuracy of detecting a tooth is also an important parameter referred to as Jitter. A good jitter performance is necessary for an accurate ignition-control. In high-end sensors, the jitter is also used to do missfire detection (crankshaft application) or to detect a false air pressure in the tire (ABS-application). This is calculated by doing FFT (Fast Fourier Transformation) and detecting some vibration on the axle or doing a prediction of the next tooth and recognizing a false timing due to early or late or even missing firing the piston. Modern crankshaft sensors based on MR technology have a jitter-value in the region of 40 nsec for a 3-sigma-value.

The active system has a quiet constant jitter over frequency as illustrated in Figure 12. There are differences of up to a factor of 5 depending on different manufacturers.

1 Comparison Hall versus VR

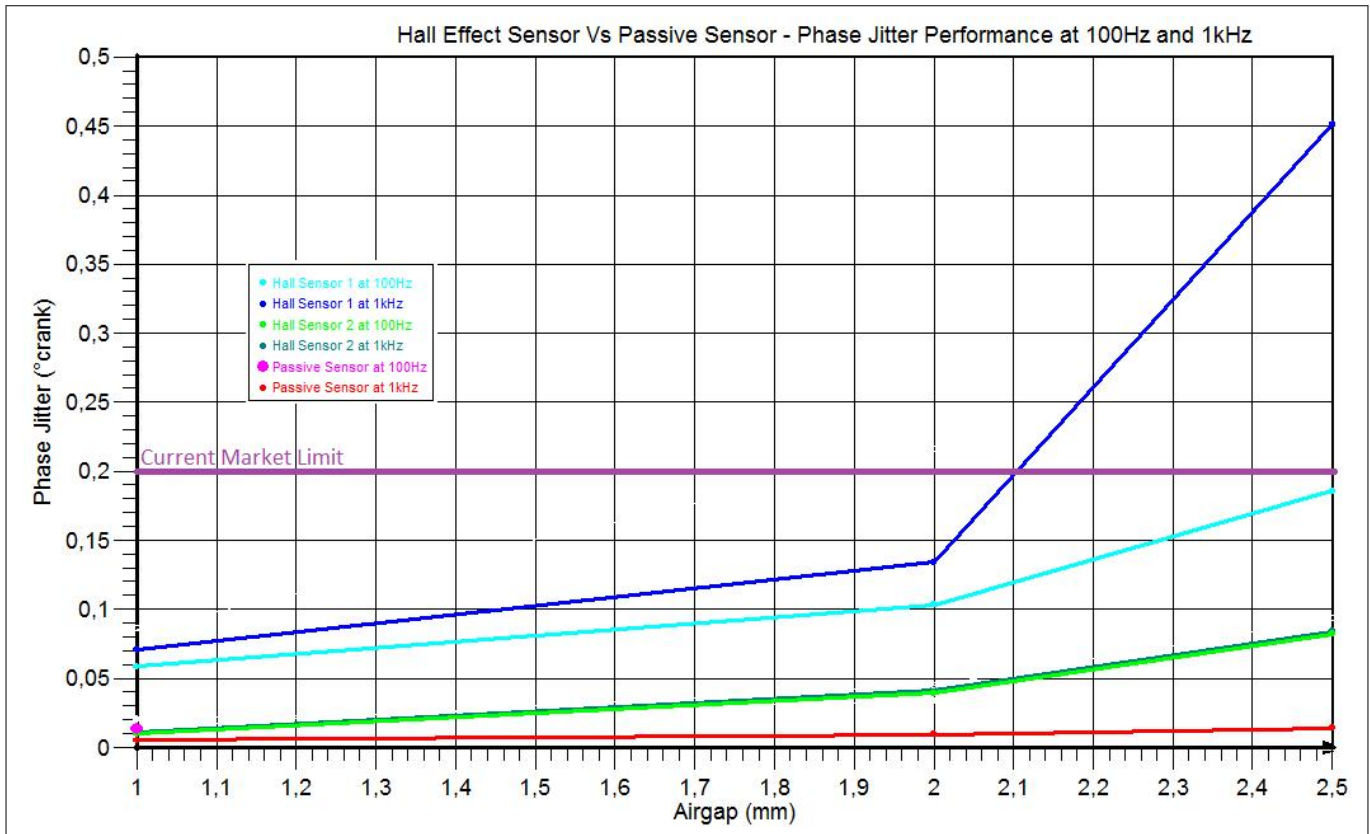

Figure 13 Phase accuracy of VR, Hall1 and Hall2 plotted versus air-gap at two different frequencies. 1°crank refers to a wheel with 60 - 2 teeth. Better accuracy can be reached by increasing the number of teeth on the wheel.

Passive systems show a strong frequency dependency. This is due to the principle of variable reluctance: When the wheel is rotating 10 times faster the signal increases by factor of 10. This results in a 10 times steeper zero-crossing of the signal and this further results in a 10 times better phase accuracy. But this works also in the opposite way. Going to low frequencies the jitter increases drastically since there is nearly no signal available any more. In the worst case signal is completely lost.

1.4.5 Electromagnetic compatibility (EMC), output signal and signal conditioning

The main difference in comparing VR-sensor with additional signal conditioning circuit and an active sensor is the length of the signal-line from the sensing element to the signal conditioning circuit: In the passive system the typical length is about 1 meter. In the active system the first amplifier is immediately beside the sensing element: less than 1mm.

1 Comparison Hall versus VR

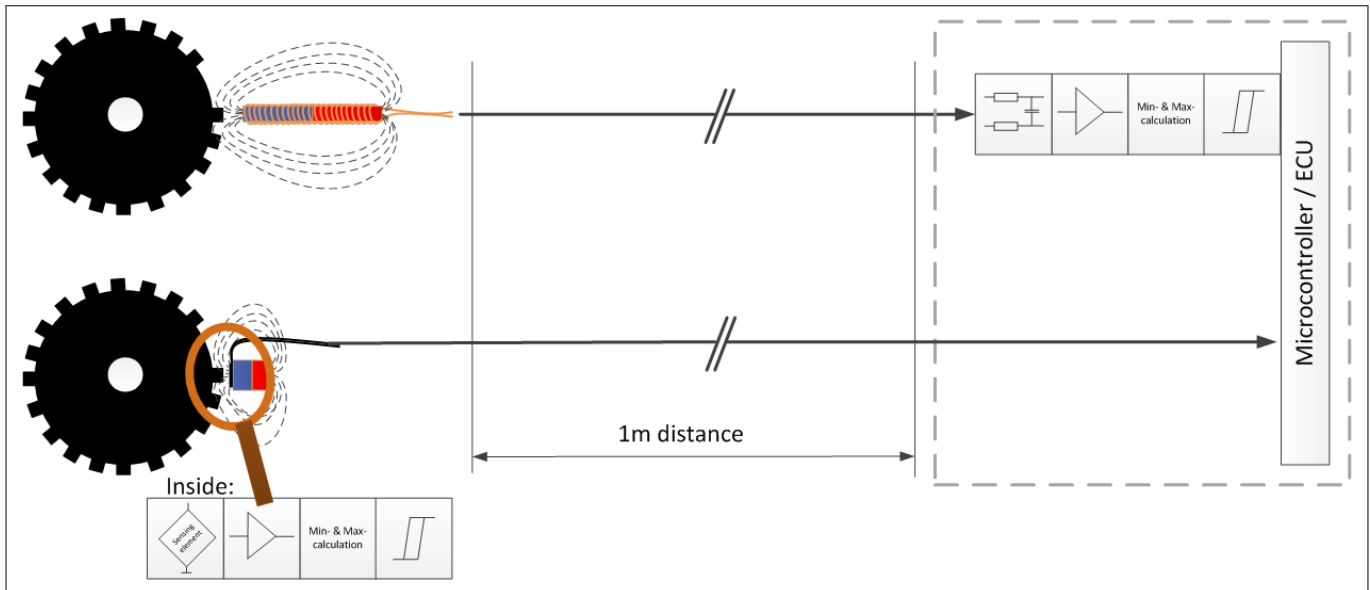

Figure 14 Length of cable transmitting the analog sensing signal to the signal-conditioning

When external electrical disturbance occurs the passive system will be affected which will result in an additional switching. In this case the active sensor has a clear advantage. Nevertheless there might be magnetic disturbance too. In this case both sensors are affected in the same way and might have extra-pulses or bad accuracy in case of large air-gap or large external electromagnetic disturbances. In high end sensors, this problem is solved by integrating multiple sensing elements. Through differential principle, speed sensing is done by calculating the difference of magnetic signal between the two sensing elements and thereby subtracting the electromagnetic disturbances along with it. The transmission of a digital signal is more immune than transmitting the analog signal to the ECU. Therefore active systems are the better solution in terms of output signal and signal conditioning.

1.4.6 Module size, module weight and mounting considerations

The size of the sensor module is one of the most relevant key parameter for combustion engines designers. A big module might need some extra-space which might limit the design. In a world of downsizing and fuel efficiency it becomes more and more important to design sensors as small as possible. There are some concepts of integrated sensors with more than one magnetic sensitive element. This is done to get homogenous stray-field-robustness or to enable direction-detection. A molded VR-sensor has usually about double the weight as a molded active hall-sensor. There is one exception to be mentioned for hall-sensors: Mounting hall-sensors in front of a multi-pole-wheel reduces further the effort in the 2nd-level-packaging (molding) of the sensor. Therefore extreme small and light weighted modules can be manufactured with technology of active sensing. This gives your transmission application or ABS application some freedom in design.

1.4.7 Direction detection and vibration detection

For future trends, there is a need to detect the direction of the wheel from the moment when the first tooth passes the sensor. Several cases need direction detection:

- Starting the engine and recognizing the direction in which the wheel is running.
- Doing stop-start of the engine to save fuel and avoid emissions. It is important to know the exact position of the wheel for doing accurate ignition at the first piston after restart at the red traffic-light. The wheel might swing over dead center position before the crankshaft finds a position where it settles. Forward and reverse direction have to be sensed and indicated to the ECU
- Vibration detection is needed in the stop-start condition as well as in transmission-wheels for vibration suppression. In the end both depends on recognizing the direction and/or the change of direction. The

1 Comparison Hall versus VR

algorithm running at the sensor is recognizing the direction change and will cancel the backward-pulse and the following forward-pulse. As a result the ECU has not to handle several pulses in both directions but only counts relevant pulses. Further the active sensor recognizes to not calibrate on vibration but stays calibrated on speed-signal

Measuring the direction is possible as soon as two sensing elements are in the system at a well known distance. Using a second sensing element in hall technology introduces the functionality of measuring the rotation direction of the wheel. Once the direction is known by the sensor, it monitors exactly the clockwise or counterclockwise movement of the wheel. According to the algorithm implemented, the vibration can be suppressed or sent to the output with a certain protocol, using information of the wheel-rotation-direction.

2 Consideration in magnetic circuit design

2 Consideration in magnetic circuit design

Introduction:

- We as Infineon want to make our valuable customer the magnetic circuit design as easy as possible.
- To do so, TLE 4922 is designed to be easily used.
 - TLE4922 is able to read every toothed wheel or magnetic encoder wheel.
 - TLE 4922 is able to sense very small magnetic signals due to the measurement principle of the monocrystal Hall sensor and its high sensitivity.
 - TLE4922 can be used with any magnet thanks to the sensing availability of both magnetic polarities.

2.1 Mechanical setup

Figure 15 and Figure 16 show the three main components of the magnetic circuit: the toothed wheel, the sensing element (TLE4922) and the back bias magnet. Typically the sensing element and the back bias magnet are molded in one module where already the cable and a mounting ring is attached. The typical module setup glues the magnet to the package of the sensing element.

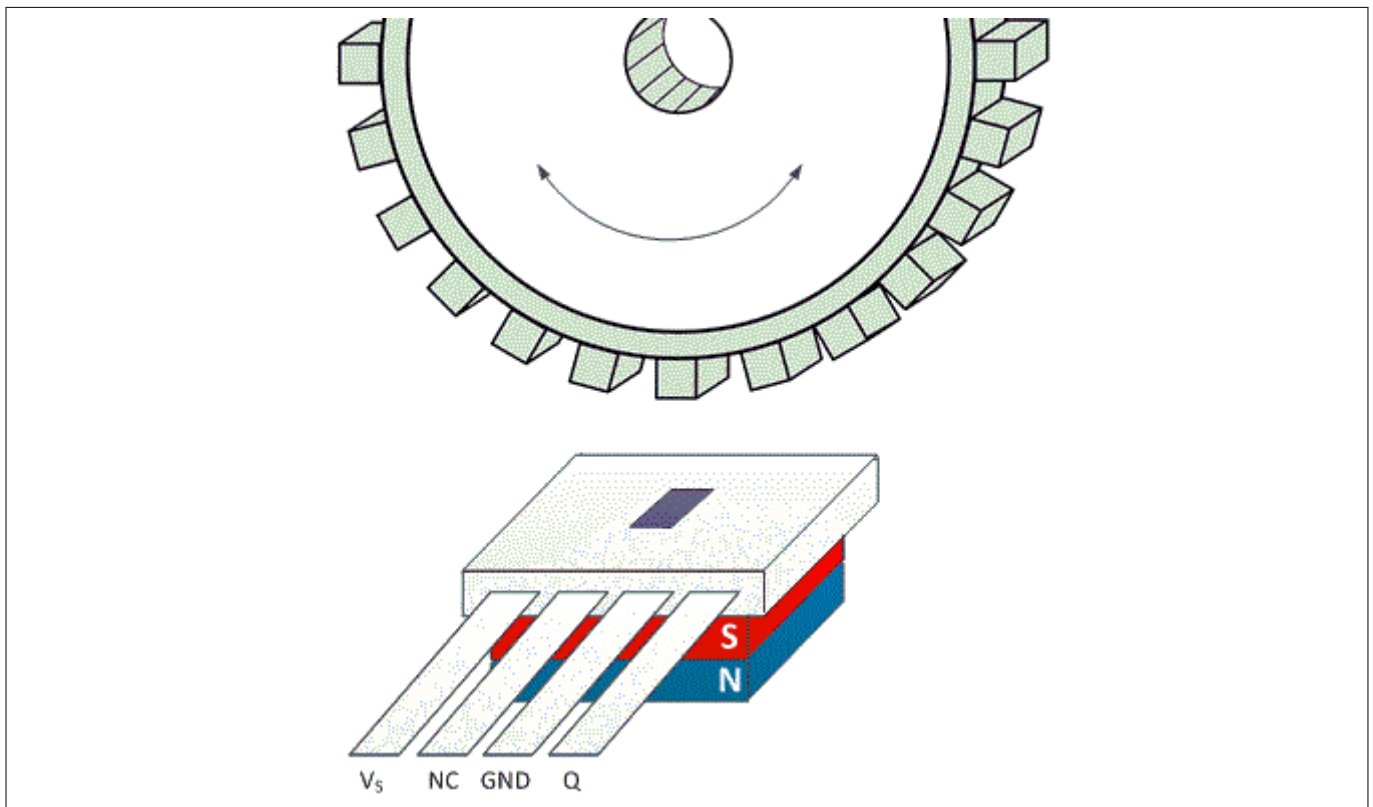

Figure 15 Schematical components of the magnetic circuit

2 Consideration in magnetic circuit design

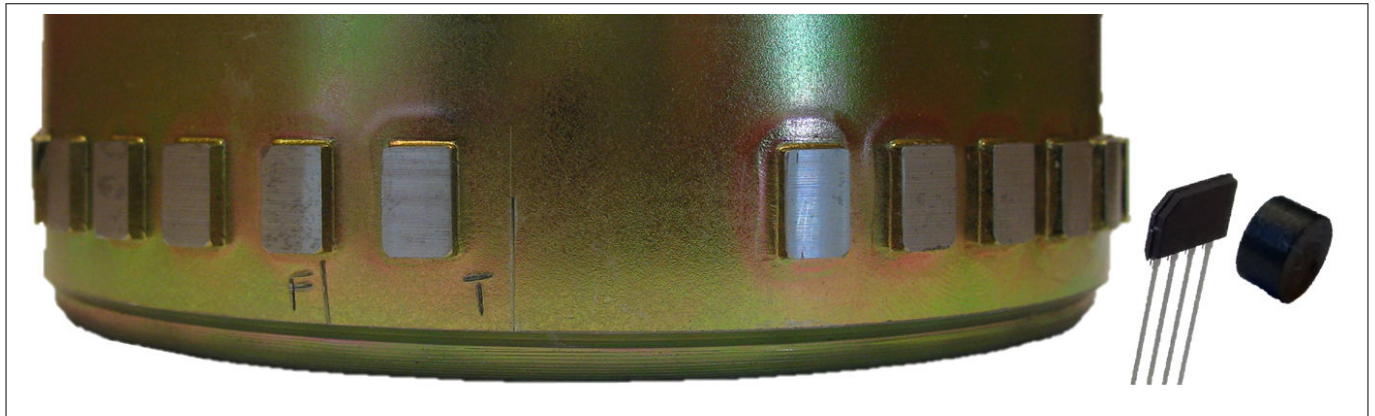

Figure 16 **Components of the magnetic circuit**

2.2 **Magnetical setup**

Depending on back bias magnet strength, back bias magnet polarity and module air gap different magnetic signals are generated by the magnetic circuit as following figures illustrate.

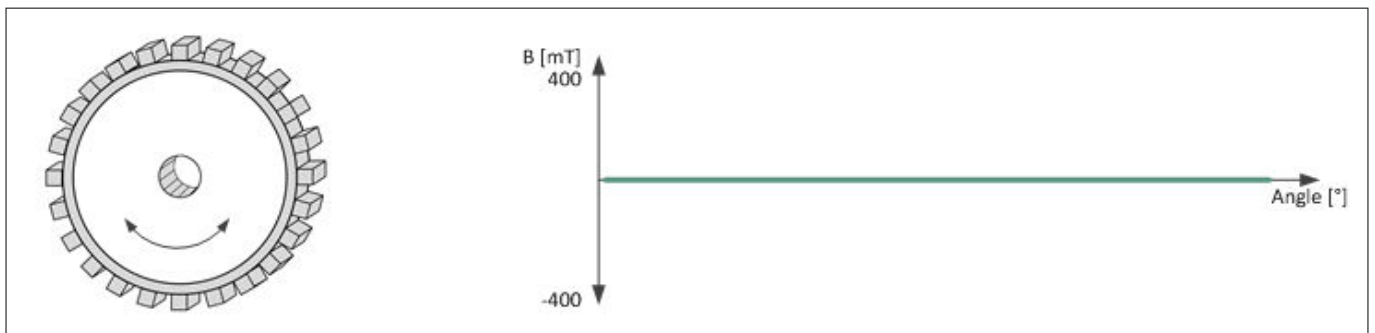

Figure 17 **Magnetic signal with no back bias magnet in place**

There is no presence of a magnet and accordingly no magnetic signal is generated.

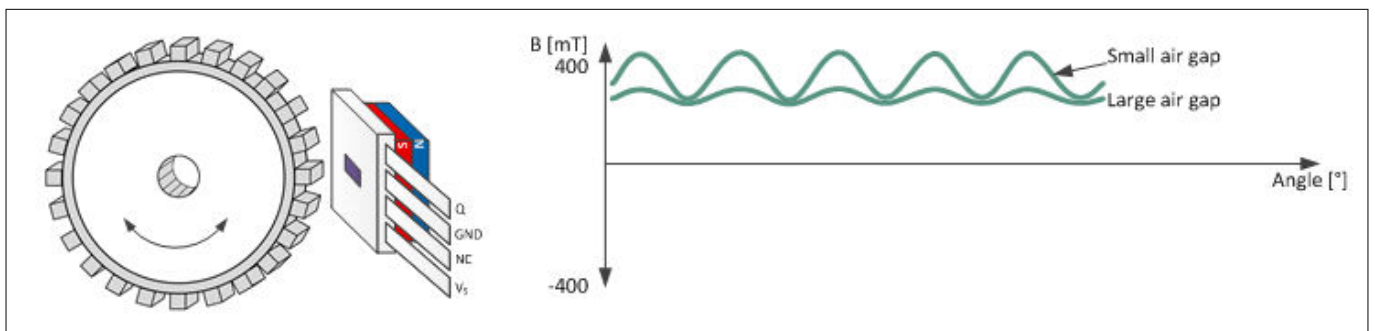

Figure 18 **Magnetic signals at two different air gaps**

Changing the air gap between toothed wheel and module changes the AC peak to peak signal. The minimum signal is representing the notch of the wheel.

By assuming an air gap change the notch has nearly no influence on the magnetic signal. But the presence of a tooth increases the flux-density. Therefore the maximum amplitude sees a big change over air gap as illustrated in [Figure 18](#).

2 Consideration in magnetic circuit design

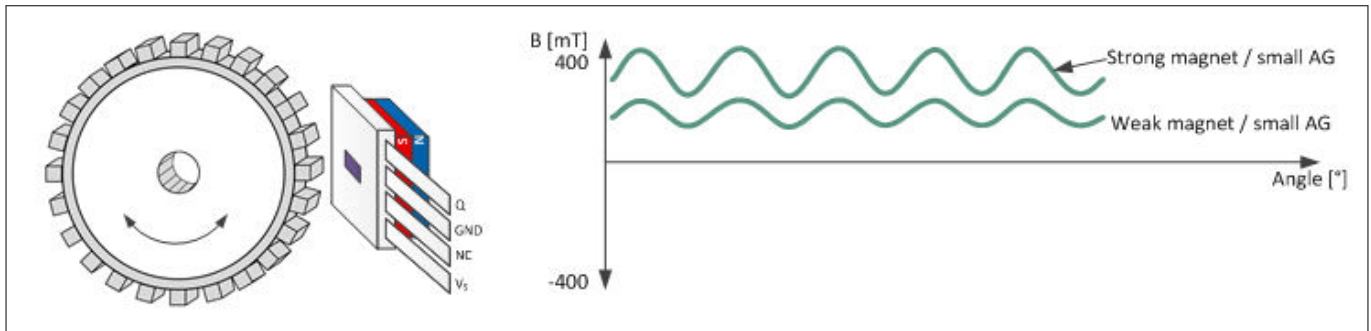

Figure 19 Magnetic signals with a strong and a weak back bias magnet

Different magnet strength has a linear influence on the sensed signal. The magnetic signal scales with the strength of the back bias magnet.

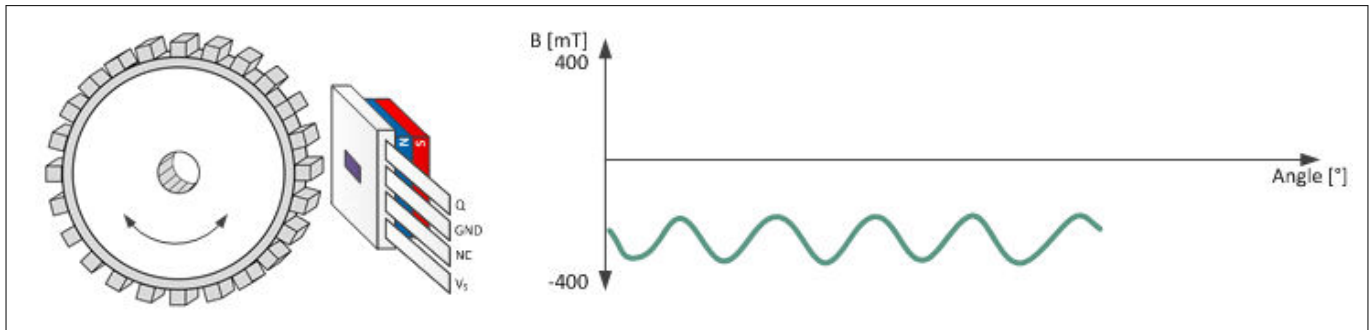

Figure 20 Magnetic signal with changed polarity of back bias magnet

Flipping the back bias magnet will change polarity of the magnetic signal. TLE4922 is capable of dealing with both magnetic polarities. A wrong polarity assembly of the back bias magnet will not be recognized immediately since TLE4922 continues switching. Since the amplitude is inverted (now the minimum value represents the tooth instead the maximum) a different behaviour could occur in the application.

2.3 Tracking algorithm of TLE4922, Offset-update

The algorithm for following the magnetic signal and updating of the threshold is property of Infineon. Therefore some details will not be given in this user manual. Nevertheless basic algorithm will be described to enable our customers to understand the capabilities of TLE4922.

2 Consideration in magnetic circuit design

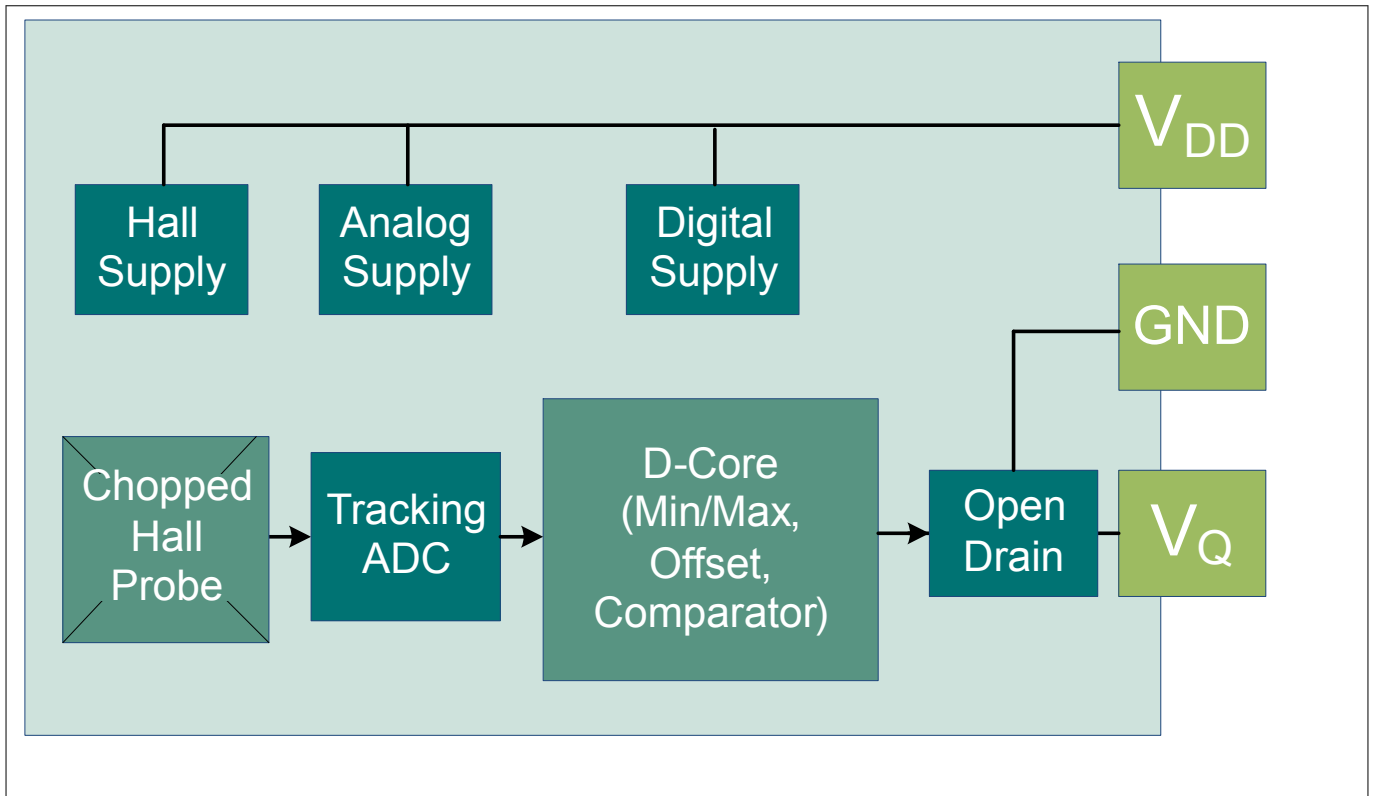

Figure 21 Block diagram of TLE4922

Basically the TLE4922 has an analog to digital conversion allowing to implement all algorithms in the digital core. Inside the digital core there is a detection of minimum, and maximum of the actual signal. Out of these values and a certain filtering functionality the actual switching threshold is calculated which is mainly the mean-value of maximum and minimum. Additionally the adaptive hidden hysteresis is calculated out of minimum, maximum and threshold value.

For standard wheels as well as for certain run out or for some air gap jumps the algorithm will follow correctly the toothed profile with corresponding switching on at the output “Q”. For a run out of more than 1mm and wheels with less than 10 teeth the algorithm of TLE4922 might not be able to follow the run-out which might result in losing some switching events on the output of TLE4922.

2.4 Flux concentration on toothed wheel, strong back bias magnet and small operational air gap

Out of the previous [Chapter 2.3](#) there has to be mentioned on special case the magnetic circuit designer has to be aware:

When TLE4922 exceeds the boundary of the full scale range (“Linear Region” in the datasheet) due to the algorithm the tracking of the magnetic signal is started at 0mT. This means the magnetic circuit designer has to take care using strong rare earth magnets in combination with a small airgap between tooth of the toothed wheel and surface of the module.

2 Consideration in magnetic circuit design

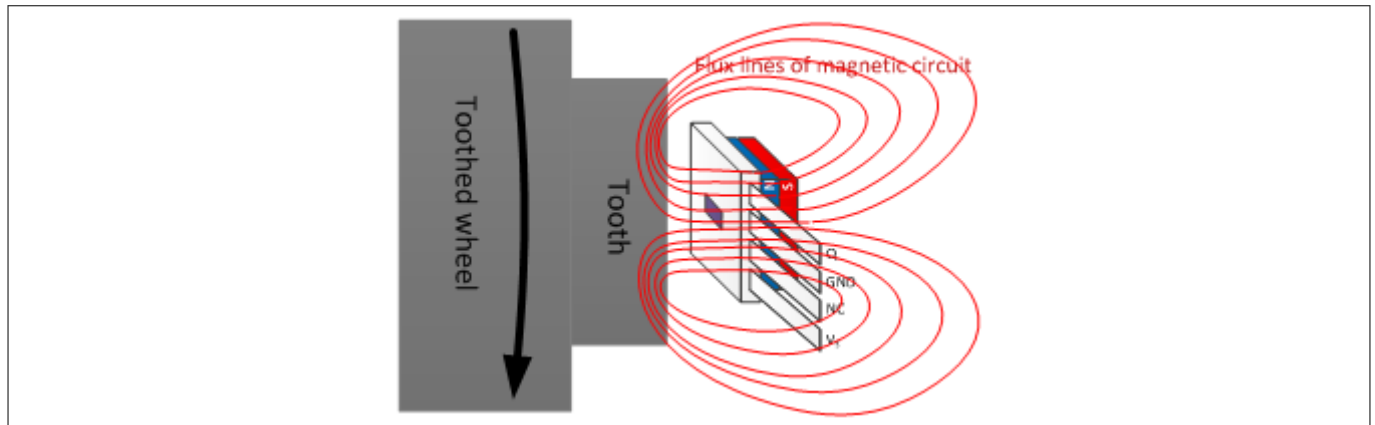

Figure 22 Flux concentration on the tooth

As illustrated in [Figure 22](#) the magnetic flux lines are concentrated in the area between the tooth and the back bias magnet. The flux-lines are allowed to go shorter due to the presence of the tooth of the wheel. As a result the field at the sensing element increases.

The magnetic circuit design has to be designed to not allow the magnetic field exceeding the “Linear Region” of TLE4922. Exceeding will cause a reset of the tracking algorithm which will most probably result in a missing tooth at the output of TLE4922.

Typically this will not happen since TLE4922 is designed as a low cost product when ferrit material is used for biasing the magnetic circuit. In the case a rare earth magnet is used a small magnet is expected to reduce at least costs. Above mentioned scenario was observed in doing system measurements with back-bias magnets exceeding 350mT at a position of 0.7mm above the surface of the magnet.

3 Customer Interface

3 Customer Interface

Once the system is defined the wheel, the magnet and the sensor have to be assessed for compatibility. Typically the sensor is placed in front of the wheel and the functionality is proven over all mounting tolerances inside the system and versus temperature and working conditions like different rotational speed or vibration. Observing the output of the sensor under these conditions make the customer free to access if the sensor is suitable for the application. To gain some safety margin the limits of the application can even be exceeded or a very bad manufactured (but within the tolerances) target wheel can be used.

TLE4922 is able to do this.

TLE4922 has an additional feature allowing the customer to access the internal signal. This enables watching the signal-processing while the toothed wheel is rotating in front of the sensor. Reading and saving this “raw data” into some spread-sheet and afterwards assessing the collected data with an assessment tool provided by Infineon gives the customer an increased confidence-level since the complete tolerances of manufacturing TLE4922 is included into the result.

3.1 Serial Inspection and Configuration Interface (SICI)

This Chapter gives an overview about the Serial Inspection and Configuration Interface (SICI). For this, the digital output (“Q”) pin is used. Furthermore it gives some programming examples and a list of the available commands.

The transmission is based on transmitting a single bit to the sensor and immediately receiving a bit. These bits form a 8bit command word, similar to the SPI interface. This makes the interface bit-synchronous and very flexible in timing.

Physically SICI is a single wire like the output “Q” of TLE4922. There is an open drain output at each end of the line and a single pull up resistor. To enable both “ends” of the line to listen, there is a comparator added on every node. So a node consists of the open drain output to send data and of a comparator to receive data.

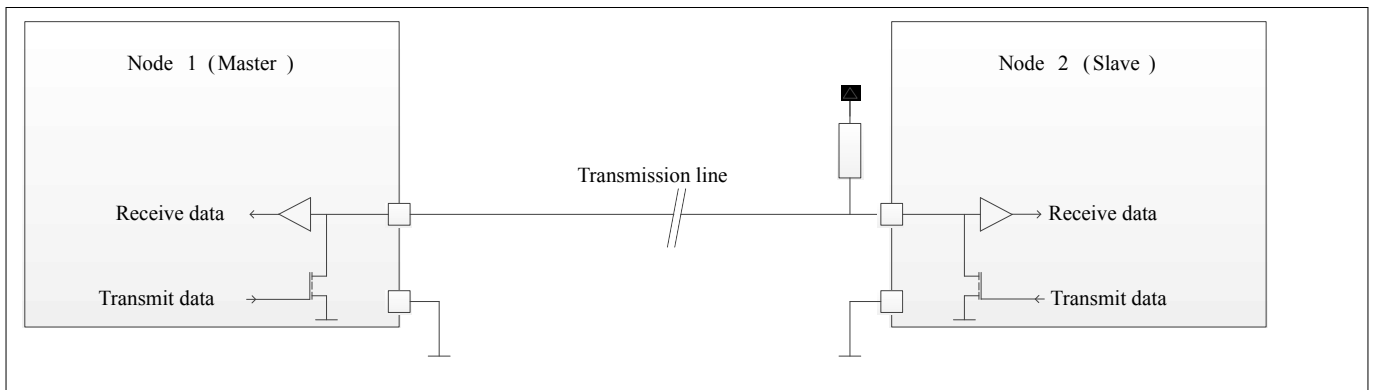

Figure 23 Physical layer of SICI

The communication using SICI will disable the standard functionality of the output following the toothed wheel and replaces it by exchanging data.

In SICI-mode the master drives some data on the communication line. The Slave is observing the output that is normally left undriven in standard operating mode pulled up by the resistor. As soon the master starts driving the line this is recognized by the slave. When the master sends the correct sequence of logical “0” and logical “1” the slave accepts the password and will also switch to SICI-mode.

3 Customer Interface

3.2 SICI protocol

SICI is a low voltage, bit-wise communication based on Master and Slave (TLE4922). Both have open drain output to drive the output-line.

The protocol is based on Master transmitting a single PWM bit and receiving one bit from slave.

The diagram in **Figure 24** illustrate the physical level of the signal for transmission and reception of “0”and “1”
 At the beginning of the communication both Master and Slave are releasing the line. In idle mode the line will stay in HIGH level due the pull-up resistor.

For t_1 Master is forcing the line in LOW.

For t_2 Master and Slave are releasing the line.

at the end of t_2 , Master if forcing the line in LOW for a very short interval, still detectable by the slave, and then it releases the line for $t_3=abs(t_2-t_1)$ to be driven eventually by the slave according to its response. When t_3 elapses, Master read out the response.

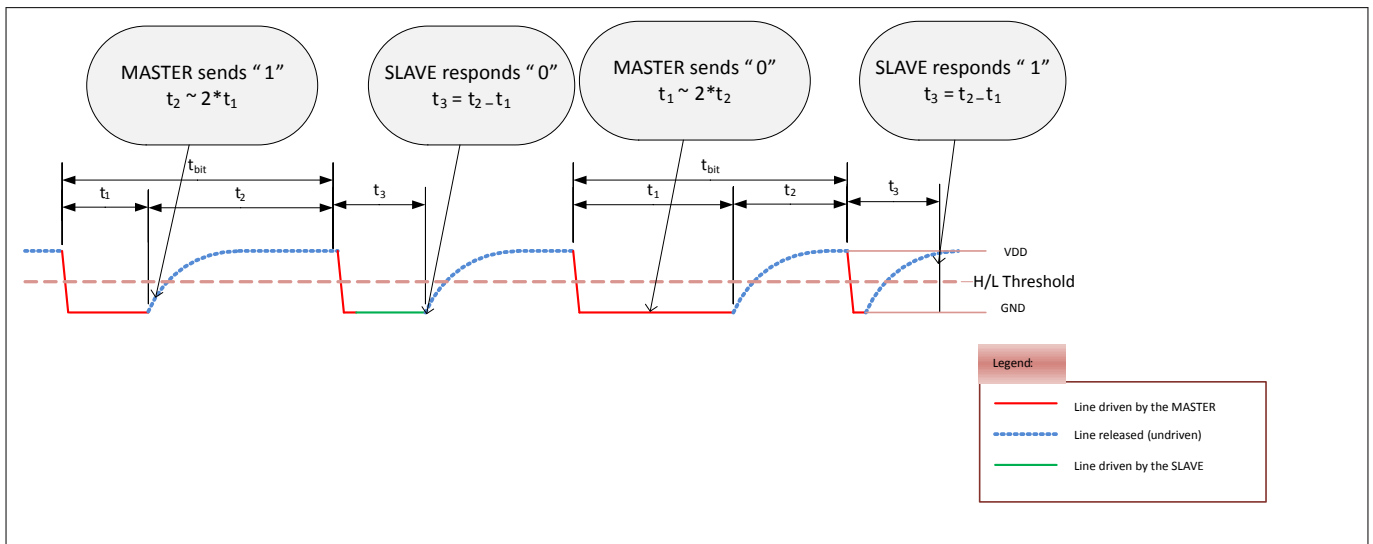

Figure 24 SICI communication - Bit timing

We choose t_1 and t_2 in such ratio to allow the device to safely distinct between “1”and “0”.

$t_1 = 2 * t_2$ - master sends “0”

or

$t_2 = 2 * t_1$ - master sends “1”

Following table presents the timing constraints for the implemented communication protocol, resulted from

Table 2 SICI Protocol Timing Constraints

Parameter	Symbol	Values			Unit	Note / Test Condition
		Min.	Typ	Max.		
SICI PWM zero master low duration	t_{11}	2	-	50	us	Duration of the “low” pulse generated by the MASTER when sending an “1” No external capacitor on Q pin
SICI pause	t_4	2	-	-	us	Time interval between to consecutive bits

A frame of 8 bits starting with “1” is named “command”.

A frame of 16 bits starting with “0”is named “data word”.

3 Customer Interface

In order to read a value, the controller should send an empty (all zero) 16bits word. The read values are the ones that have been sampled at the beginning of the received empty data word - first negative edge of the word.

For the command words the device will respond with the same value as the one sent to it.

A violation of protocol - incomplete bit or incomplete word shall force the device output Q in “LOW”, hence further communication shall not be possible and the device shall be restarted with a power on restart.

3.3 Test modes activation

In order to enter the test modes and execute a test, the Master has to apply the following sequence (**Figure 25**):

- ramp -up supply V_s
- In t_{test_setup} but at least t_{reset} after ramping supply VDD initialize a SICI communication and send TEST_PSWD1 word
- Using SICI protocol send the actual test mode configuration command optionally followed by one parameter

It is mandatory that no conditions for switching due magnetic field variation are met before complete receiving of the signature command otherwise the device shall not enter in test mode.

If the initialization command is received prior to elapsing of $t_{power-on}$ (see datasheet), the device shall unconditionally enter the test mode.

If the initialization command is received prior to elapsing of t_{test_setup} (typically 20msec) and no switching conditions due variation of external magnetic field are met, the device shall enter the test mode.

If the initialization command is completely received after t_{test_setup} the device shall not enter test mode.

Due to the receiving of initialization command fails due protocol violation, the chip shall not enter test mode.

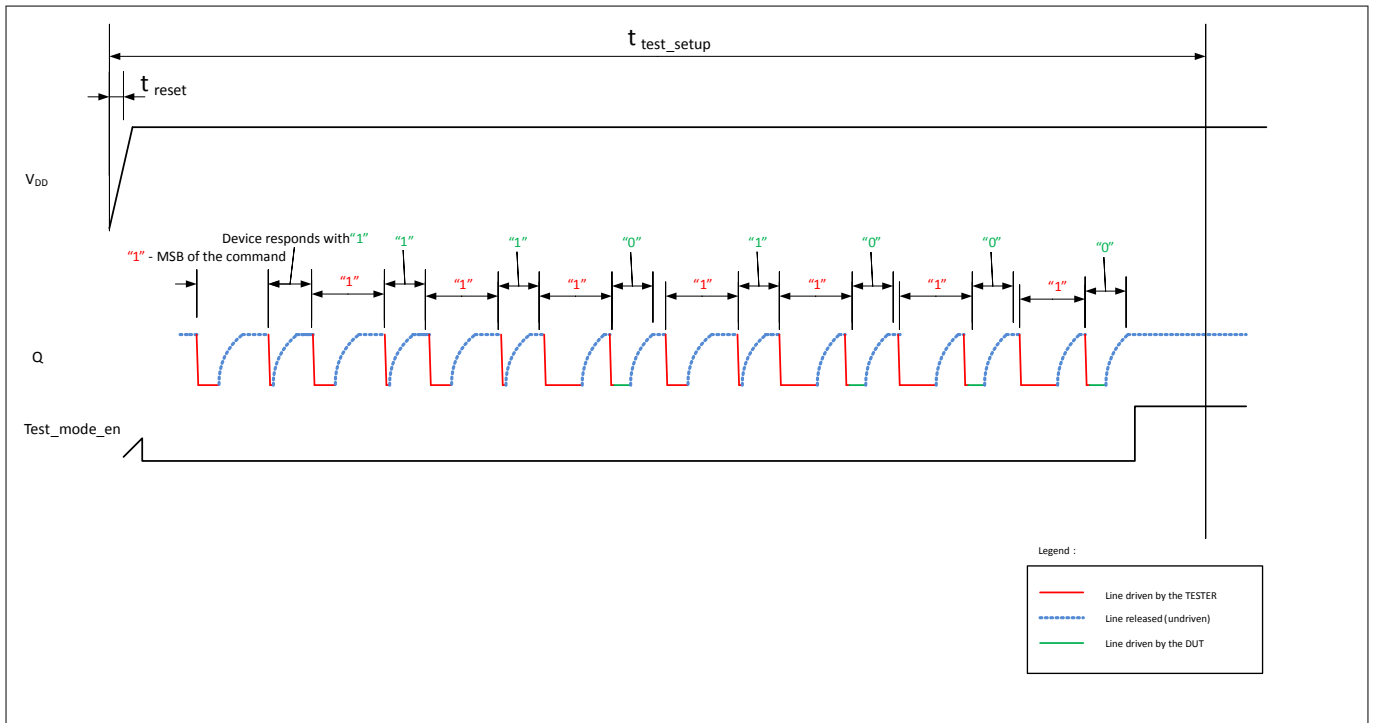

Figure 25 SICI Interface enable sequence

In order to exit the testmode, the master shall normally reset the device via a power-on-reset sequence.

3 Customer Interface

3.4 Command codes

As mentioned before four registers of the TLE4922 can be read after accessing the Interface-mode written in following table.

Table 3 Command codes reference

Command type	Command binary code									TM	Command Result
Command	7	6	5	4	3	2	1	0			
WRITE											
	1	1	0	0	0	1	0	1	0		Activates test mode
READ											
	1	0	1	0	1	1	0	0	1		read MIN register
	1	0	1	0	1	1	0	1	1		read MAX register
	1	0	1	0	1	1	1	1	1		read threshold register
	1	0	1	1	1	0	1	0	1		Read demodulated filtered tracking (IIR output)

Further commands are implemented for productive end of line testing and therefore not item of this user manual.

4 Evaluation Kit / Mapping Tool

4 Evaluation Kit / Mapping Tool

To enable our customer to do system evaluation on his own Infineon provides the “TLE4922 MS2GO”-Evaluation-kit.

As a first evaluation the delivered module TLE4922 + ferrite back bias magnet is able to sense the magnetic shape of a toothed wheel. The customer can choose to watch the output-switching following the teeth of the wheel or is allowed to watch the internal signal of TLE4922 corresponding to the magnetic field. A range of +/-500mT is displayed over time. TLE4922 acts like a linear Hall sensor with digital interface as described in [Chapter 3](#).

This magnetic mapping may be stored on the disc of your computer and processed by a further tool “iMAT - Speed Viewer” to do assessment on air gap and accuracy.

After successfully testing the customer can replace the Infineon-module by the customer module and repeat the evaluation using the Infineon-interface (small red pcb).

Even in the application and at the end of manufacturing-line the customer can connect the evaluation kit to evaluate the quality of mounting or the quality of the wheel.

- Bent tooth detection
- Damaged magnetization detection
- Maximum run out acceptance
- Maximum / Minimum airgap acceptance

4.1 “TLE4922 MS2GO” - Hardware

The hardware to do a first evaluation of TLE4922 in a customer application consists of an Infineon module holding a ferrite back bias magnet and a TLE4922 as pictured on the left hand side of [Figure 26](#) and an interface-pcb enabling communication between PC and TLE4922.

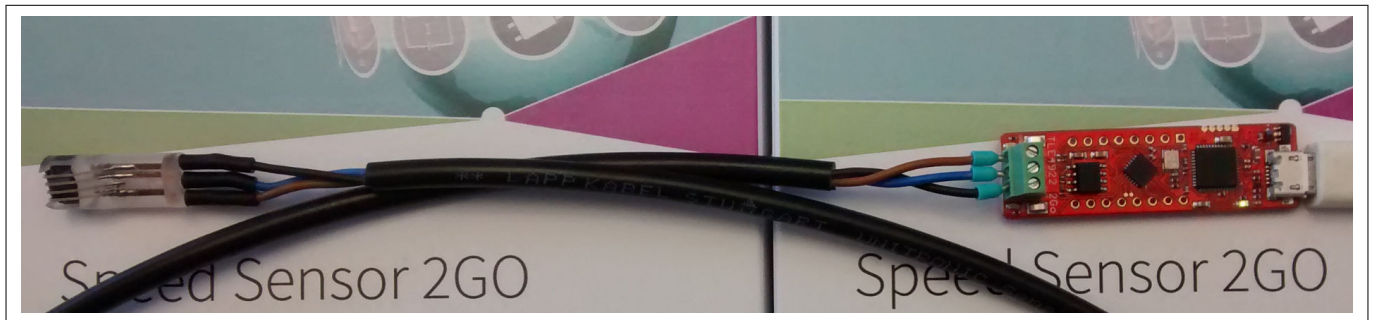

Figure 26 Hardware of “TLE4922 MS2GO”: Module and pcb

The pcb is able to enter the digital 5V interface of TLE4922. It follows the S.I.C.I-standard.

Any module with a TLE4922 inside may be attached to the pcb. 3 wires have to be connected. The pull-up resistor is onboard the pcb.

4 Evaluation Kit / Mapping Tool

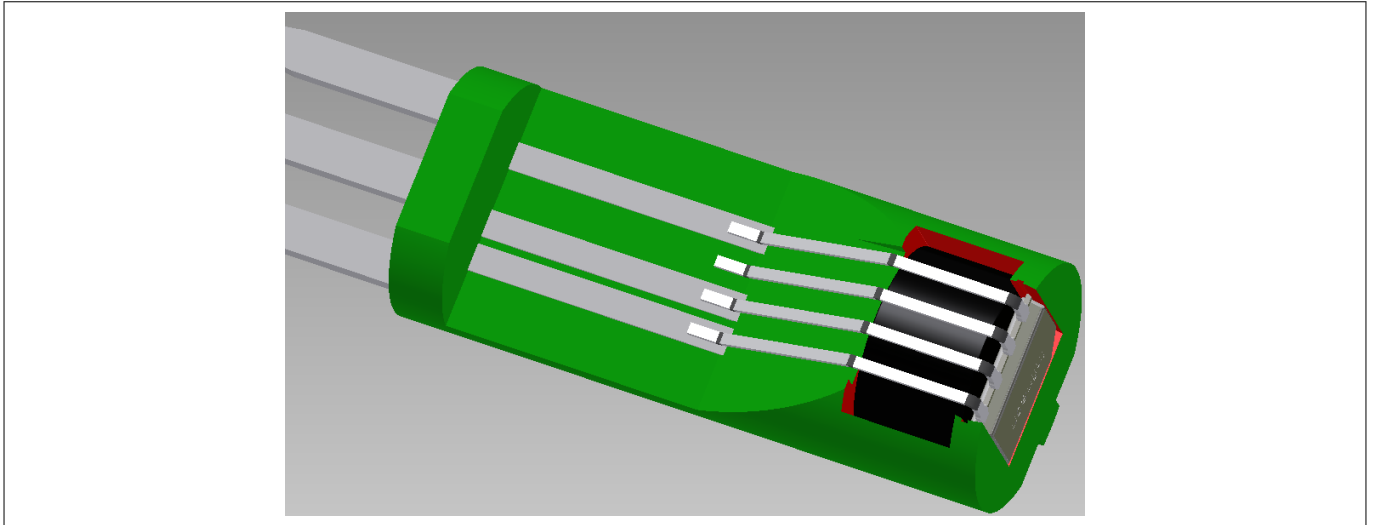

Figure 27 TLE4922 MS2GO: schematic of module

The module holds a magnet made from standard ferrite. this material is independent from large price dependency like observed on rare-earth material in the last years. In ferrite material an air gap up to 4 mm can be achieved. Rare earth material like SmCo or NdFeB can go for 6mm of air gap and further improved jitter-performance.

The nominal value of the used ferrite magnet is 120mT in 0.7mm distance above the surface. This is the distance of the sensing element inside TLE4922 to the front of the package.

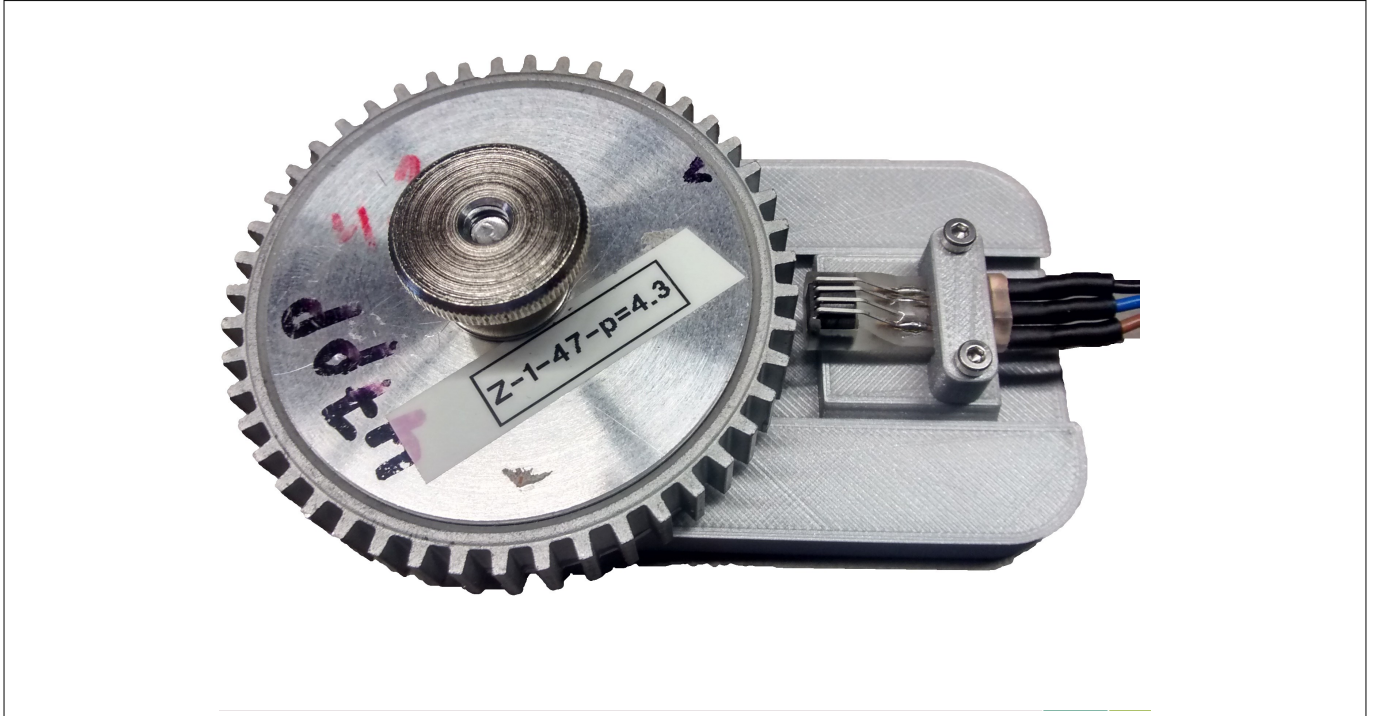

Figure 28 Low-cost demonstrator: TLE4922 MS2GO in front of a toothed wheel

Intention of the TLE4922 MS2GO - kit is demonstration of working principle based on Infineon's low cost speed sensor and a low cost back bias magnet made from ferrite material.

4.2 “TLE4922 MS2GO” - Software

On the Infineon web-page at the download area the software for the TLE4922 MS2GO - kit can be downloaded.

4 Evaluation Kit / Mapping Tool

URL: www.infineon.com

The opened software appears like **Figure 29**.

In the left area the USB-connected kit will be found and displayed. Please choose “XMC-device COM xxx”. In the case no device is displayed please check your USB-connection or unplug and plug in again.

The second step is to choose between one of the two existing modes:

- Mapping mode: The TLE4922 acts like a linear Hall Sensor and will display the magnetic field in the range from -500mT to +500mT.
- Functional mode: The output will switch according the toothed wheel in front of the sensor. Notch of the wheel will be a LOW voltage state. Tooth of the wheel will be a HIGH voltage state.

With the “Start”-button the Evalkit will start capturing the requested data: Either magnetic field-data or detected tooth and notch.

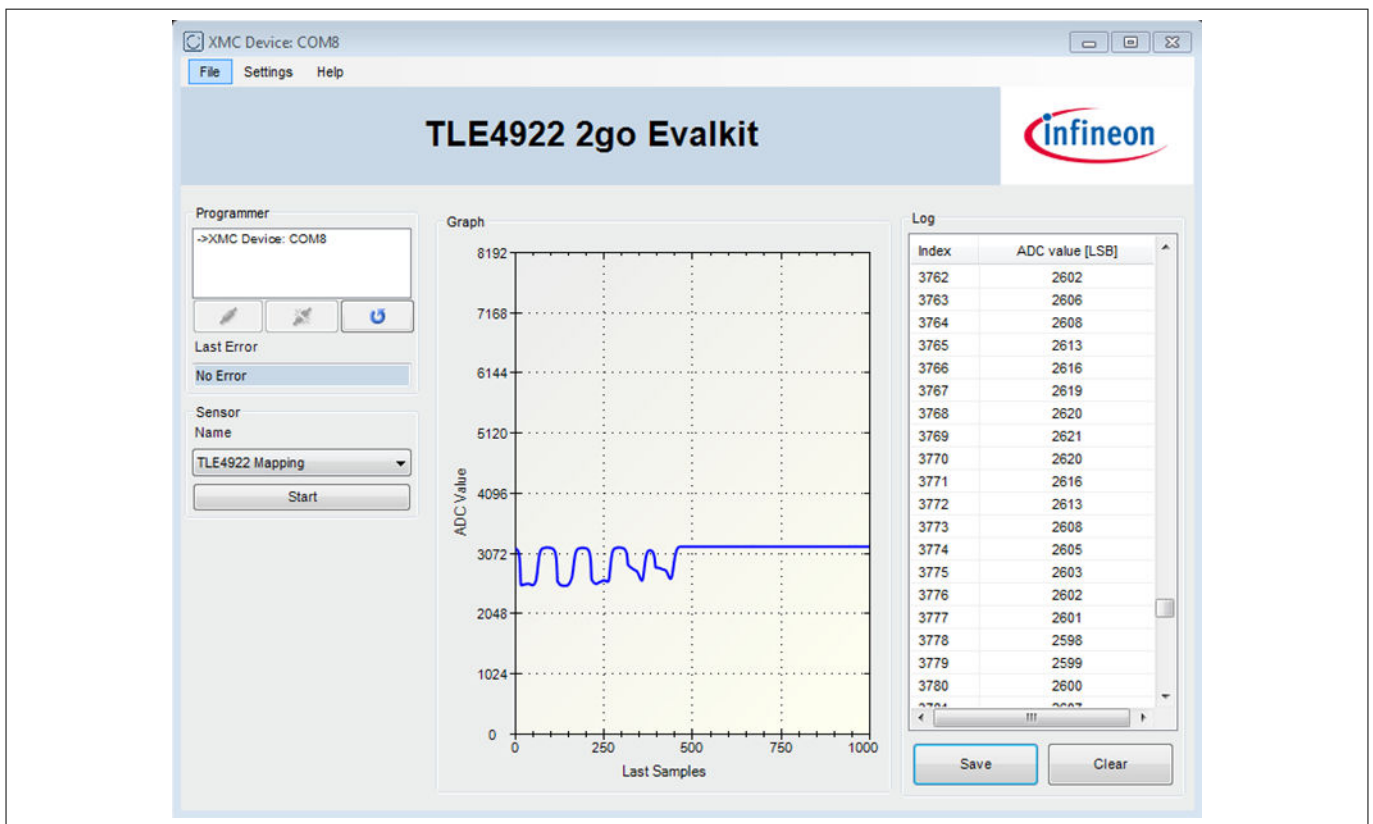

Figure 29 Screenshot: Evaluation kit TLE4922

In the middle area a graph is indicating the requested data over time-axis.

In the right area the captured data is available in numbers. These numbers can be exported into textfile or MS-Excel for further post-processing.

4 Evaluation Kit / Mapping Tool

4.3 iMAT - Speed Viewer

Assessing captured data from the evaluation kit is traditionally done in any post-processing-tool like Matlab, Excel, NI-DIADDEM or any other software. For standardized assessment of essential application parameters like:

- Minimum airgap assessment
- Maximum airgap assessment
- Maximum runout acceptance
- Bent tooth detection
- Phase accuracy

An Infineon-tool called “iMAT” can be used as well. For further details on this Infineon-software please contact your local Infineon field application engineer.

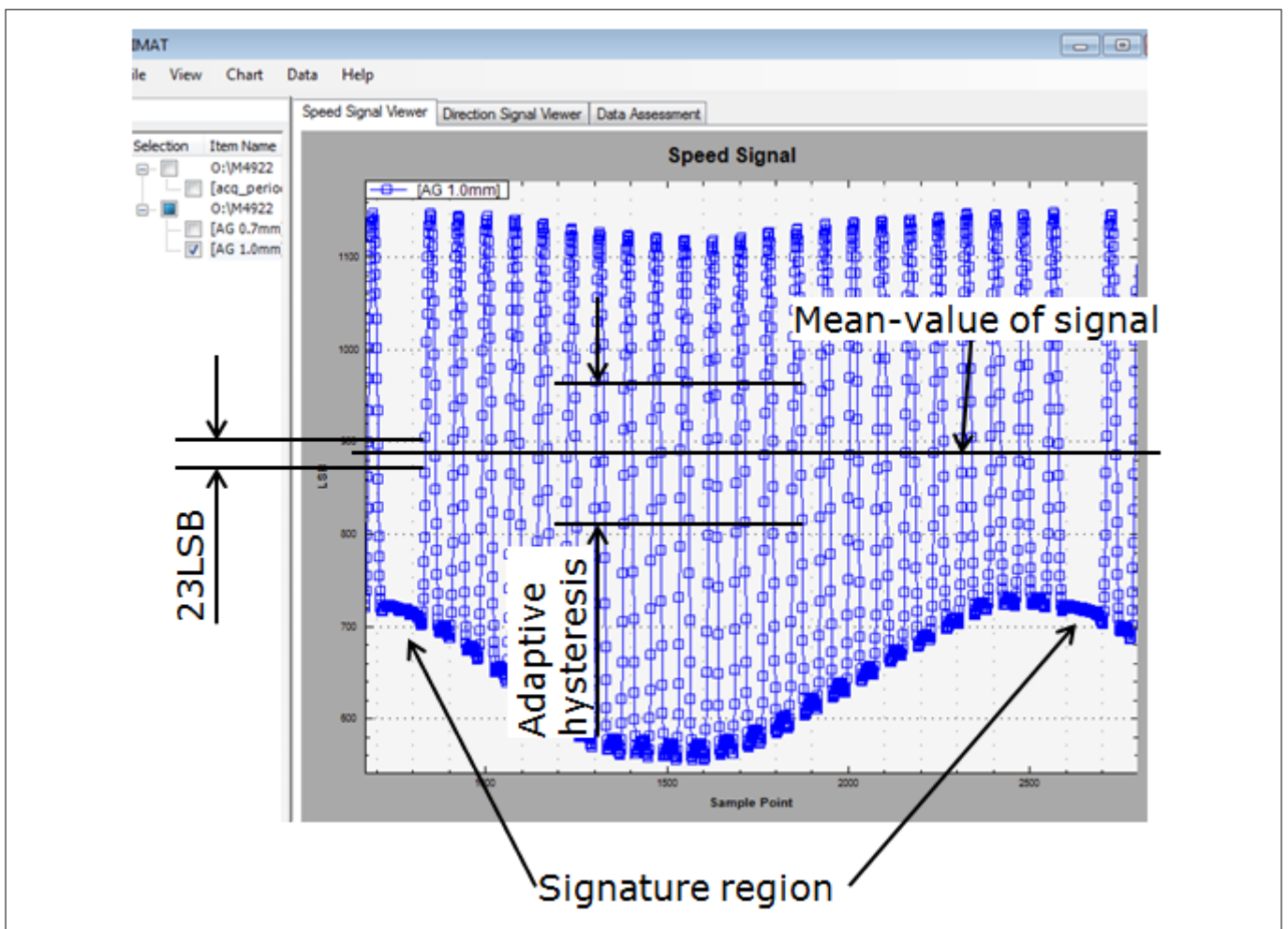

Figure 30 Screenshot on iMAT

5 Frequently asked questions

5 Frequently asked questions

5.1 What is the working principle of TLE4922? Can you explain the blockdiagram?

As mentioned in chapters before TLE4922 is a very basic type of sensor as can be seen on the small number of functional blocks in the block diagram (Figure 31).

The supply is supposed to be nominal between 5V and 15V. Out of this supply voltage three voltage regulators are generating the supply voltage of the sensing element (Hall supply), of the analog domain (Analog supply) and the digital domain (Digital supply).

At the chopped Hall Probe the magnetic field B_z is already converted from magnetic field into an electrical voltage. The technical principle of chopping cuts off the random offset of the Hall probe itself. Typically every hall probe has some random magnetic offset moving over temperature and mechanical stress. TLE4922 compensates the magnetic offset through spinning the supply-voltage of the Hall probe to all 4 directions and calculating the average.

In the functional block “Tracking ADC” the the electrical voltage of the Hall probe is converted into a digital number. Converting into a digital domain has the advantage of easy implementation and simulation of algorithms.

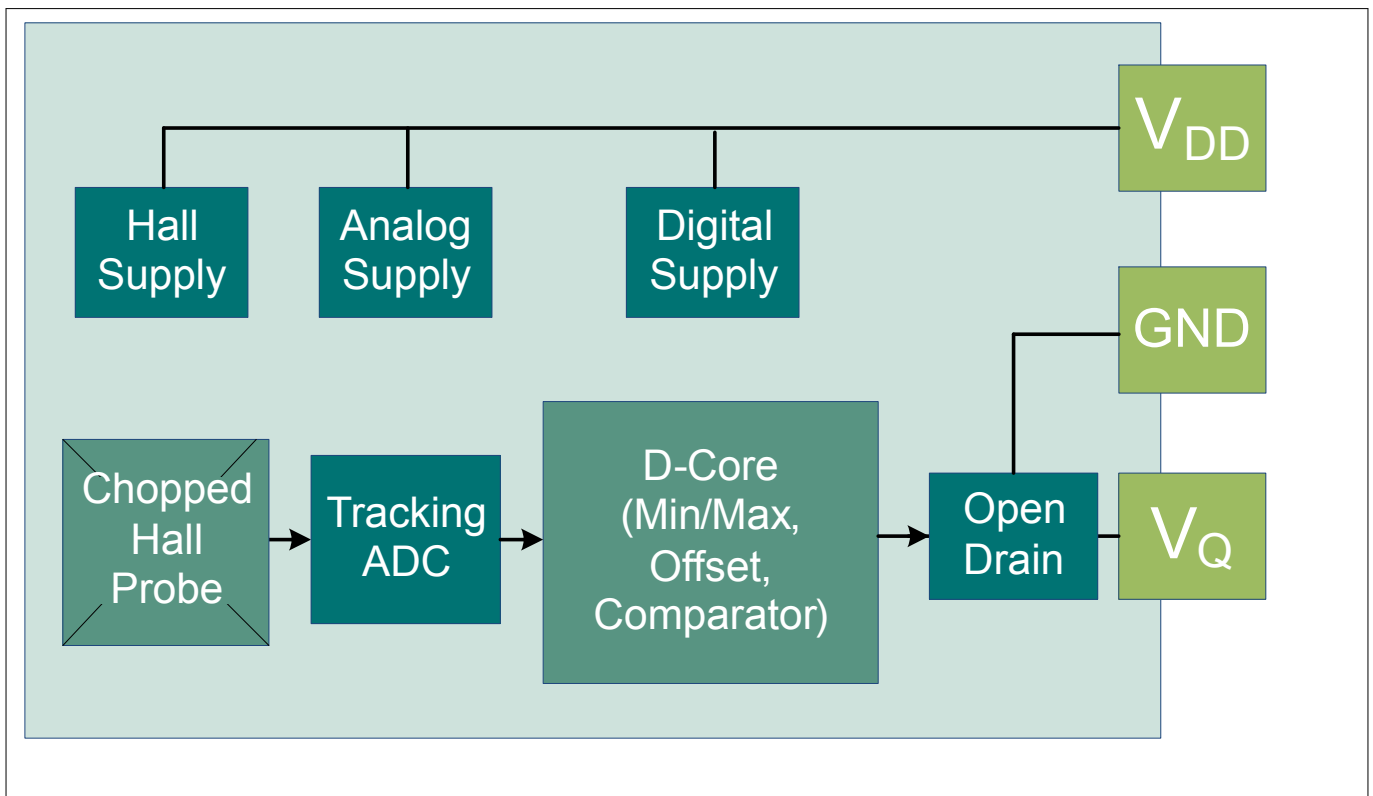

Figure 31 Block diagram of TLE4922

In the digital core itself the signal is tracked all the time. Algorithms allow to detect the minimum and the maximum of the magnetic field representing a tooth and a notch of the toothed wheel. Out of the found minimum and the found maximum the threshold for the switching event is calculated in taking roughly the mean-value. In reality there is some averaging implemented to be not too sensitive on magnetic distortion but still allow TLE4922 to follow a run out of the wheel or some air gap jumps. Due to implementation of a hidden adaptive hysteresis the sensor is insensitive to vibration or manufacturing tolerances of the toothed wheel as well as positioning tolerances of the module.

5 Frequently asked questions

Finally the output of the digital core drives the Open Drain Output. This is not a simple transistor but protected through short current detection and thermal shut down in case of an overload.

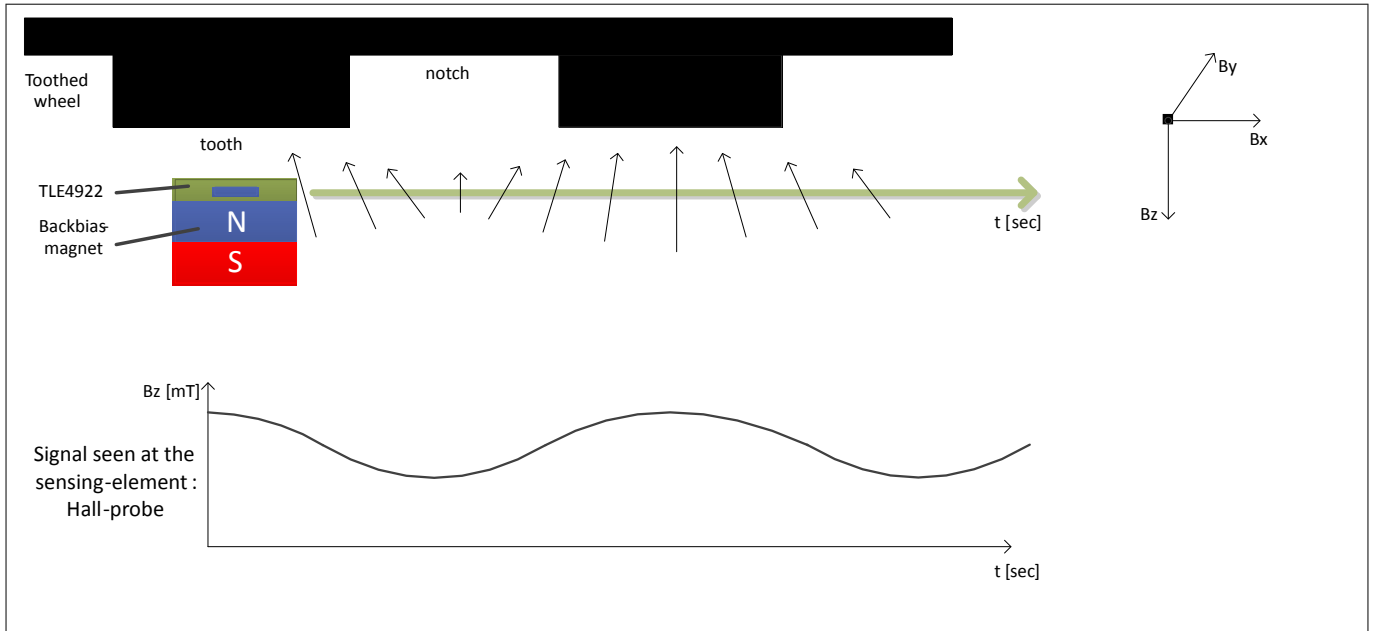

Figure 32 Magnetic field in front of a toothed wheel

The field vectors of a magnet will be deviated by a toothed wheel as illustrated in [Figure 32](#). In front of a tooth the amplitude of the field will increase since the tooth is working like a flux-concentrator and is shortening the effective length of the flux. In front of a notch there is only little influence on the magnetic circuit since the air gap between toothed wheel and magnet is too large. The chopped Hall probe of TLE4922 is able to sense the Z-component of magnetic field.

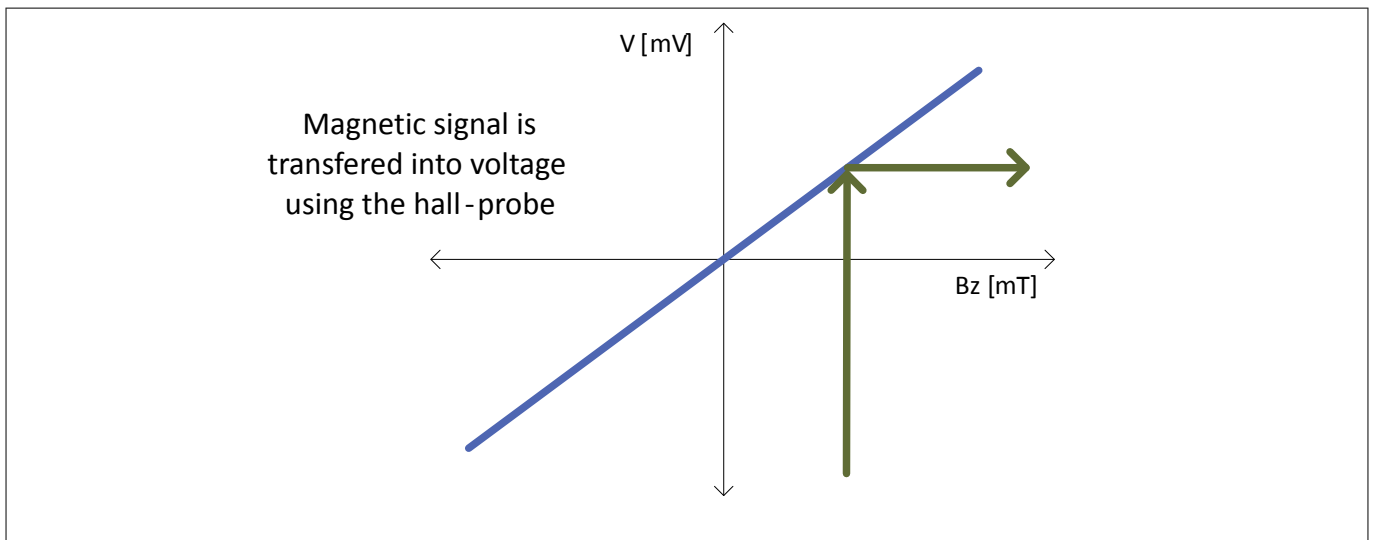

Figure 33 Transfer-curve of a Hall probe

A Hall probe transfers perpendicular magnetic field into electrical voltage. The effect is linear over the whole range.

5 Frequently asked questions

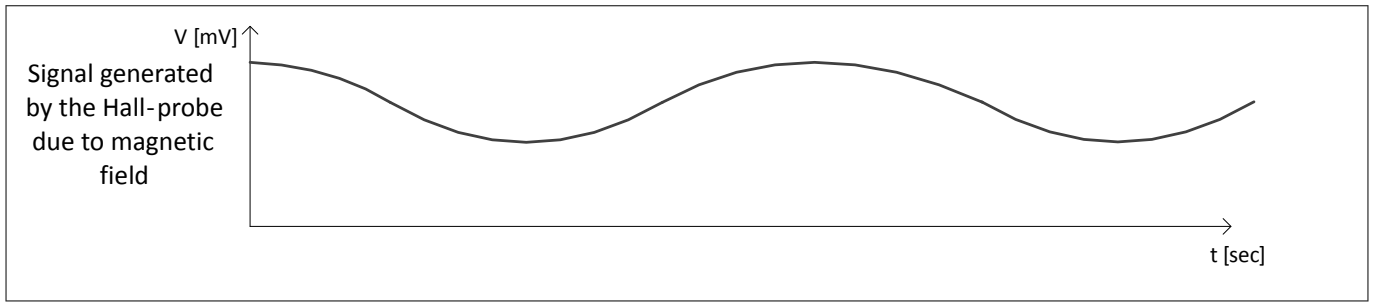

Figure 34 Signal at output of the Hall probe

A setup as shown in [Figure 32](#) will result in a signal at the output of the Hall probe as illustrated in [Figure 34](#). The B_z is directly converted into a voltage. Due to special chopping technique of TLE4922 the intrinsic offset is already cancelled out.

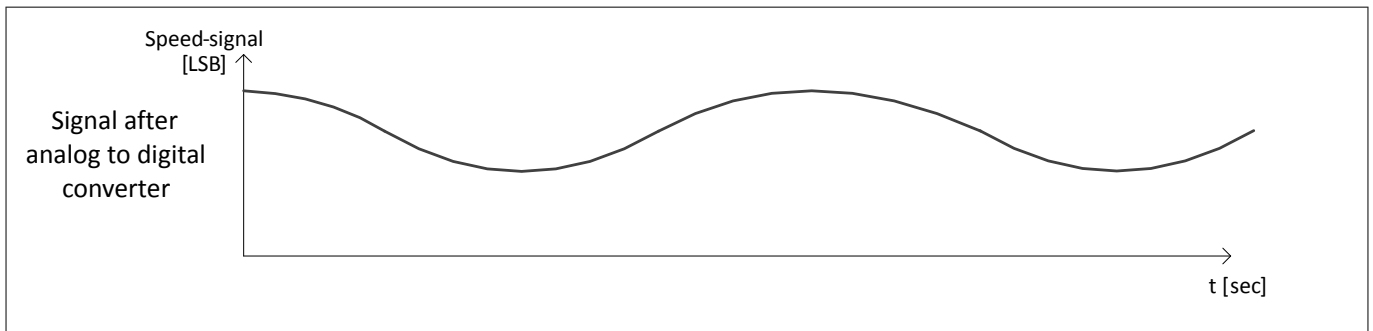

Figure 35 Signal at output of the ADC (Analog to Digital Converter)

The tracking ADC of TLE4922 converts the electrical signal of the Hall probe into a continuous stream of digital numbers. These numbers are ready to be processed in the digital core of TLE4922. The shape of these digital numbers represents the B_z at the Hall probe.

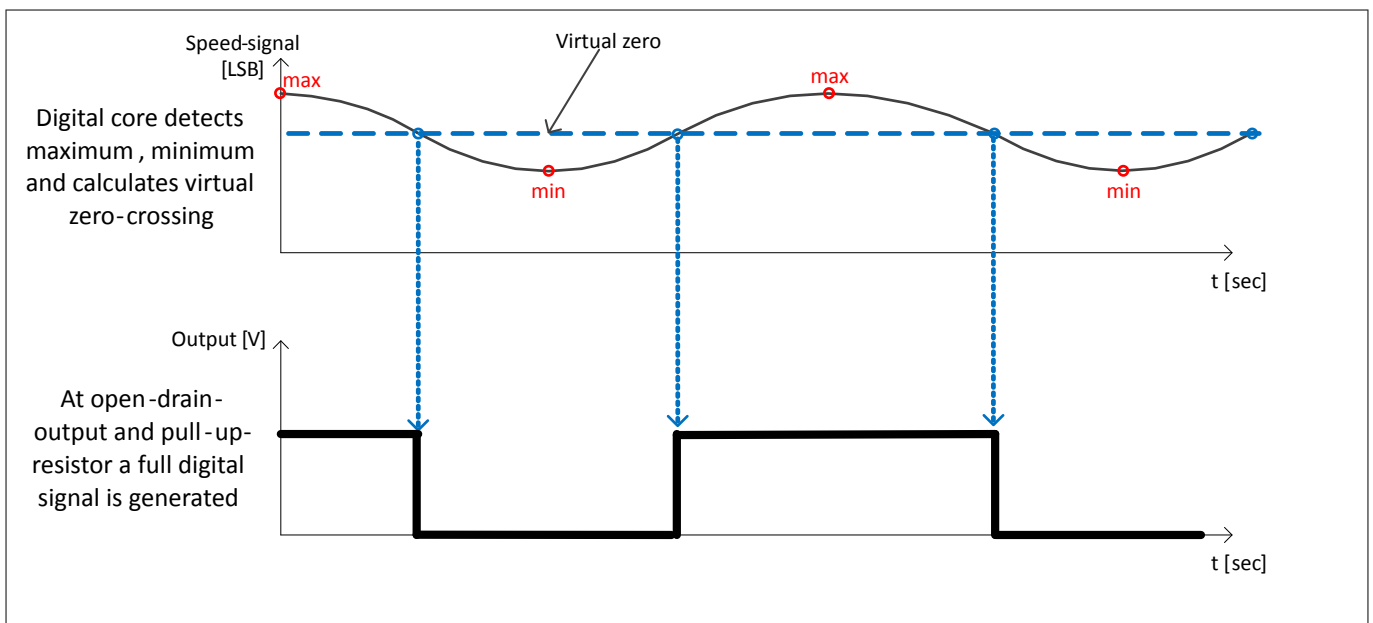

Figure 36 Simplified scheme of the switching algorithm in TLE4922

The digital core of TLE4922 is able to calculate all the digital numbers coming from the tracking ADC. It follows the signal and detects the minimum and the maximum in the signal as indicated with red dots in [Figure 36](#). With these numbers the meanvalue is calculated which gives the switching threshold level. Whenever the signal

5 Frequently asked questions

crosses this threshold level a switching event at the output is triggered: falling and rising edges according to the magnetic signal.

To prevent unwanted switching near the switching threshold a hidden adaptive hysteresis is implemented. Hidden means the hysteresis can not be measured using any measurement-device. It is simply an additional threshold that has to be crossed by the magnetic field before a further switching event is released. Adaptive threshold means this level is not fixed but is a certain percentage of the last measured amplitude (max-value minus min-value).

Additionally there are some algorithms implemented to make the output switching robust against external magnetic stray-field influence, to handle run out of a target wheel, handle some sudden air gap jump or avoid additional switching on vibration.

5.2 Can you give me some details on start up behaviour and calibrated mode? How many magnetic edges are needed for stable operation?

TLE4922 has different behaviour during on the very first output-pulse provided on output-pin “Q” as on all following edges.

After start up time the sensor does not know if a tooth, a notch or a transition from either tooth to notch or from notch to tooth is in front of the sensor. Therefore TLE4922 can not work as described in [Chapter 5.1](#). As described in running mode TLE4922 has to know one minimum and one maximum in the magnetic field to calculate the meanvalue representing the switching threshold.

For the first edges after start up time a different algorithm was implemented to not miss any edge of the output-signal starting at “high”-level right after start up is finished.

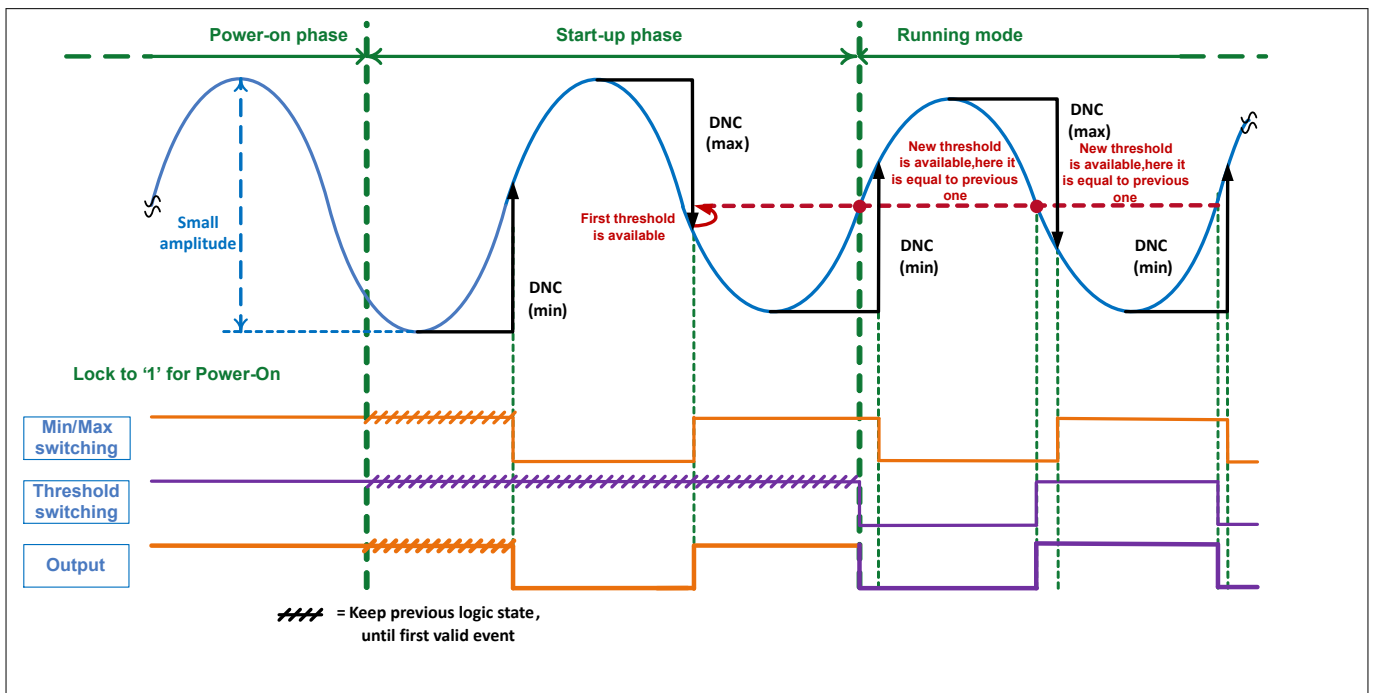

Figure 37 Transition between modes

Power on phase:

In this phase TLE4922 starts tracking the magnetic signal during power up of all voltage regulators. Working points of the analog circuit have to settle and therefore the digital core can not trust this signal. As a result the output “Q” is kept in “high” (logical voltage level “high”) for typically 700µsec. This number is reflected in the datasheet as “Power on Time”.

Start up phase:

5 Frequently asked questions

In start-up phase it is important to not miss any edges. Every active sensing technology is suitable for detecting very slow signals. A Hall-sensor fits perfect to detect the first edge after start-up. Following the signal in [Figure 37](#) TLE4922 will see a magnetical minimum signal and then a mangetical signal starts to increase.

Inside TLE4922 a minimum signal change is implemented which is called Digital Noise Constant (DNC). After exceeding this minimum needed signal change TLE4922 will switch the signal-output to digital “low” as indicated in the picture. Since the amplitude is not known at this time the edge might be too early or too late compared to further teeth of this wheel.

The magnetic signal is now reaching a maximum and the number is now decreasing. As soon the DNC is exceeded. The output-switching is performed on detected maximum field and the detected DNC which makes the detection of the maximum valid.

With this valid maximum and minimum of magnetic field TLE4922 calculates the switching threshold and enables the third and final phase.

Running mode / Calibrated phase:

In the “Running mode” TLE4922 switches in the middle of the magnetic field and considers hysteresis as well. Final accuracy is reached. Under certain startup conditions this will take up to three magnetic edges. Typically two edges are needed.

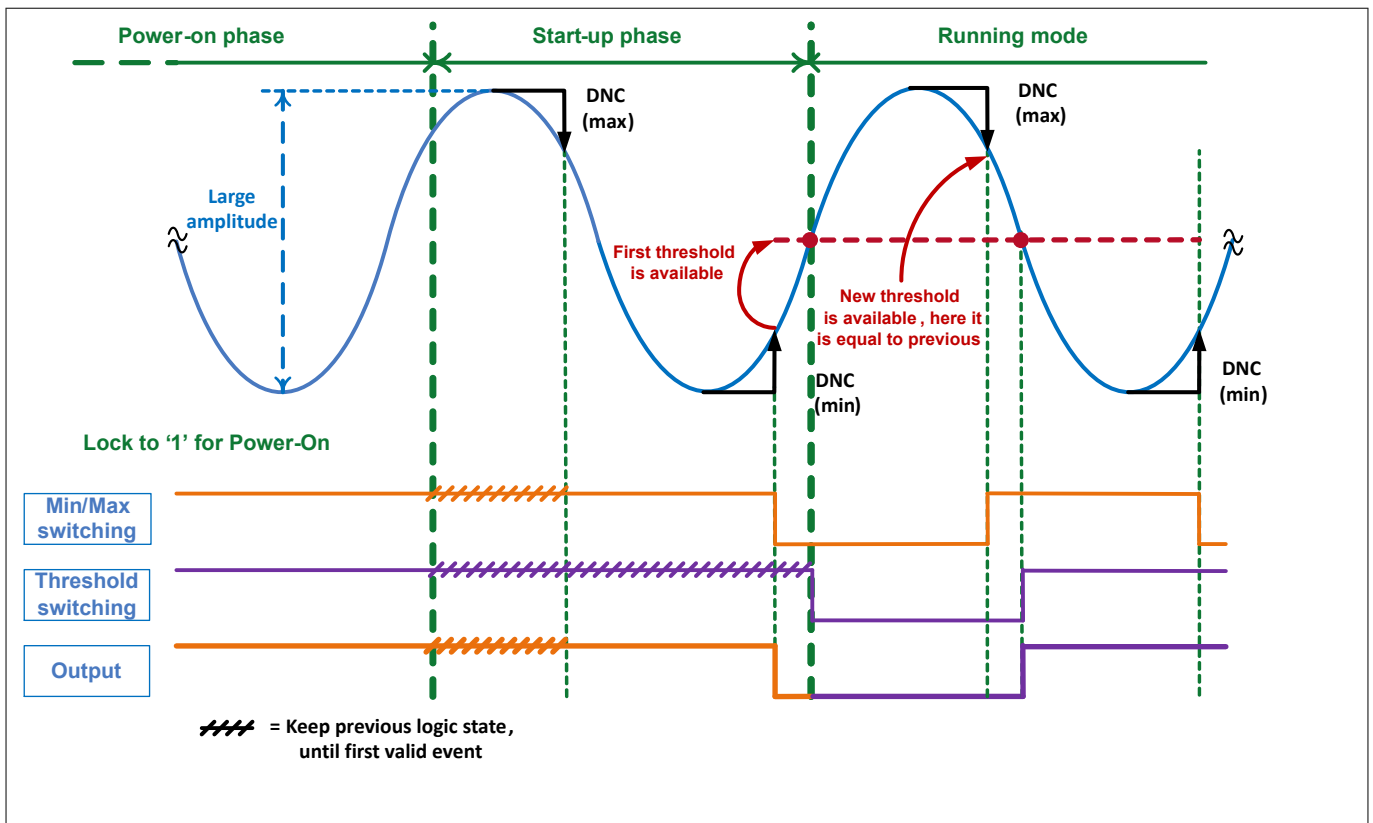

Figure 38 Transition between modes (case 2)

In [Figure 38](#) a special case is illustrated. As can be seen during the start-up phase the first edge is detected and a switching to “high” is initiated. Since the output “Q” is already at “high” no change can be observed. The magnetic edge is not visible at the output. After the second extrema the falling edge at the output is visible. TLE4922 calculates the threshold since it can be calculated now. Running mode is now switching on all further edges on calculated threshold.

This example makes clear to take care on “magnetic edges”, “output signal edges” and “pulses” which consist out of two edges.

5 Frequently asked questions

5.3 How does the hidden adaptive hysteresis concept work?

Two features are implemented in TLE4922 to enable precise switching points at zero-crossing and to suppress vibration and noise.

The hidden hysteresis concept introduces two additional thresholds above and below switching threshold of TLE4922 as illustrated in [Figure 39](#).

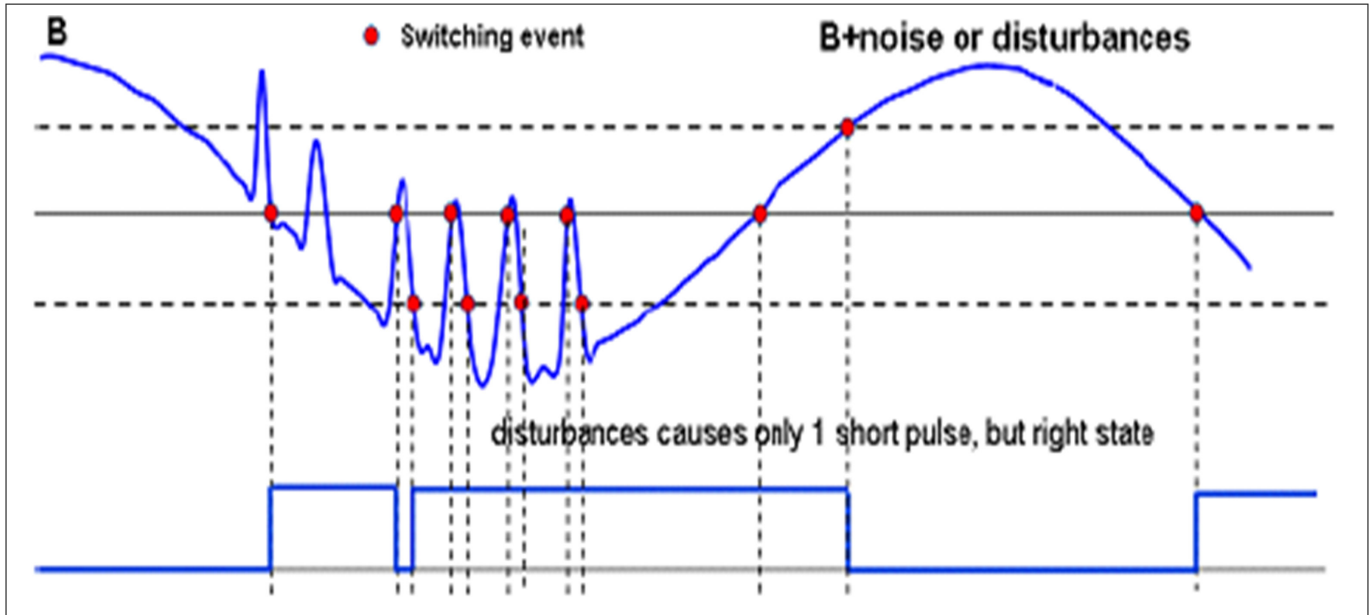

Figure 39 Hidden hysteresis concept

Hysteresis means the magnetic field has to pass not only the switching threshold to put a switching edge to the output “Q” but requires one additional crossing of a hysteresis threshold. Additionally the positive and the negative hysteresis threshold has to be passed alternating.

In [Figure 39](#) the first red dot indicates the crossing of the switching threshold which directly responds into a switching event at the output “Q” since the positive hysteresis threshold was crossed before.

Following crossing of the switching threshold due to noise will not lead to any output edges since no hysteresis threshold was exceeded in between.

After some noise is as big as exceeding hysteresis threshold and switching threshold one additional output-pulse is generated at output-pin “Q”.

Further noise will be ignored since the positive hysteresis threshold was not crossed. After crossing the positive hysteresis threshold the output “Q” is enabled again and a corresponding falling edge is visible.

As soon as noise is not in the system any more switching of the output is done at zero crossing of the switching threshold.

The strength of this implementation is avoiding additional switching on noise and minimizing additional switching due to vibration to maximum one pulse. Of course as soon as vibration is as big as one tooth this can not be recognized by the system any more.

Hidden hysteresis means described functionality with two hysteresis threshold not visible at the output during normal operation.

Adaptive hysteresis describes an adapting hysteresis level depending on the amplitude of the magnetic field of the last detected teeth. In TLE4922 the hysteresis threshold is calculated as 12.5%-value of the last peak-to-peak-value from minimum to maximum. Positive hysteresis threshold is switching threshold + 12.5% of last amplitude. Negative hysteresis threshold is switching threshold - 12.5% of last amplitude.

5 Frequently asked questions

The adaptive hysteresis threshold allows TLE4922 to follow the run-out of the toothed wheel where at the same time signal to noise-ratio is increased at small air gap in the application. Together with some update-rules this fits perfect for crankshaft application.

5.4 What is the minimum air gap?

In the datasheet the parameter “minimum air gap” is specified and verified at a certain wheel also mentioned in the datasheet. Due to restrictions of the measurement setup the minimum air gap able to be verified is 0.5mm.

In the case of no run out of the target wheel and accurate positioning a minimum air gap of 0.0mm can work. In the application a minimum air gap of 0.0mm is possible as long as BLR (parameter “Linear Region”) is not exceeded.

Be aware the tooth of the toothed wheel increases flux density and in combination with a strong back bias magnet the minimum air gap might be 0.5mm or even 1.0mm. Typically this should not be an issue since TLE4922 is overmolded by customer mold-compound. Details are explained in [Chapter 2](#).

5.5 What types of magnets can be used?

TLE4922 is designed to deal with every type of magnet as back bias magnet. The designer of the magnetic circuit has to take care to not exceed 400mT at the sensitive position of TLE4922 as described in [Chapter 2](#). This has to be considered for minimum air gap performance.

On the other hand the maximum air gap has to be achieved. Typical air gap performance of 3mm with anisotropic ferrite material based magnets can be achieved. Typical temperature behaviour of minimum needed field is shown in [Figure 40](#).

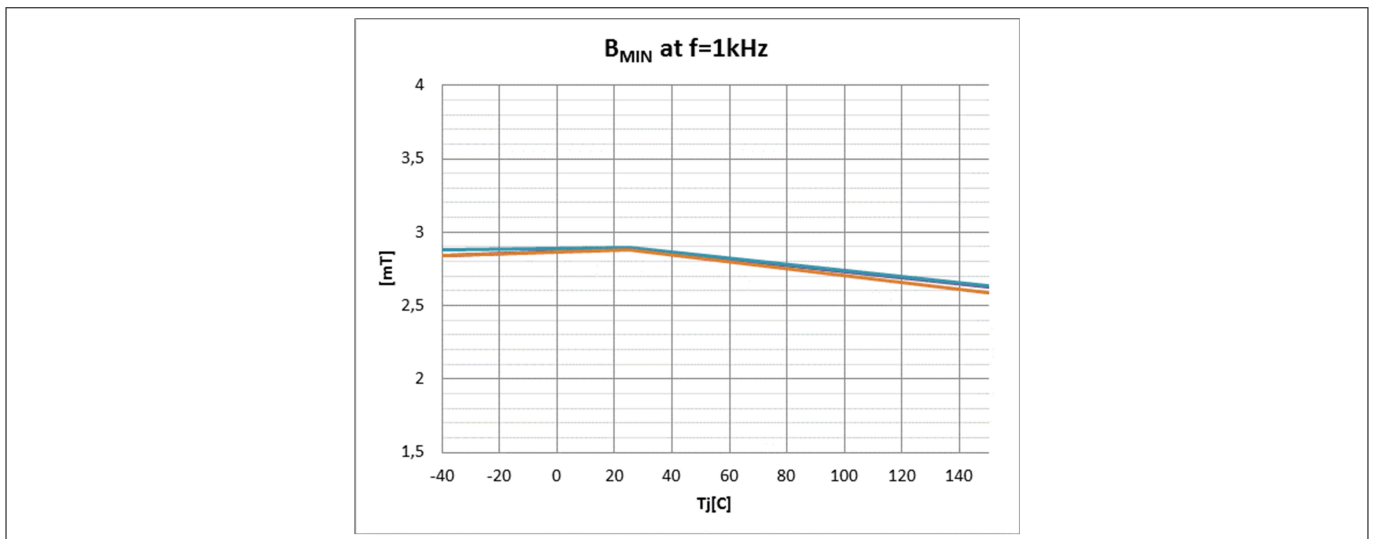

Figure 40 Minimum field needed for output switching (typical value)

Customers have to do a trade off on costs, features and performance choosing either NdFe, SmCo or Ferrite magnet material.

5.6 What is the reset voltage of TLE4922?

TLE4922 is used to operate in “Operating voltage range” as stated in the datasheet.

Due to reason of EMC-events and external series resistor in Vdd-line the reset-level is of interest. Typical reset levels at Speed-Sensors with voltage interface at Infineon are between 3 and 4 volts. The reset level of TLE4922 is not specified.

Three Vdd-voltage ranges have to be considered:

5 Frequently asked questions

- Below reset level the sensor does not operate and the behaviour is not defined. The output will be high impedance and the current-consumption might deviate from datasheet specification.
- From reset level to minimum value of operating range the sensor TLE4922 has full functionality in terms of digital core and algorithms but might deviate in some specified parameters from the datasheet. Analog working points will not be settled and therefore some deviation might occur.
- Above minimum value of operating range TLE4922 is fully functional according to datasheet

5.7 Can TLE4922 be used together with a magnetic encoder wheel?

Magnetic encoder wheels have alternating magnetic poles on their surface as pictured in [Figure 41](#). TLE4922 is able to handle these wheels very easily since the field strength is in the range of $\pm 100\text{mT}$. Compared to the capability of TLE4922 with more than $\pm 400\text{mT}$ this application is easy to handle. The magnetic field has typically no offset and due to the hysteresis concept TLE4922 is the perfect sensor for encoder wheels.

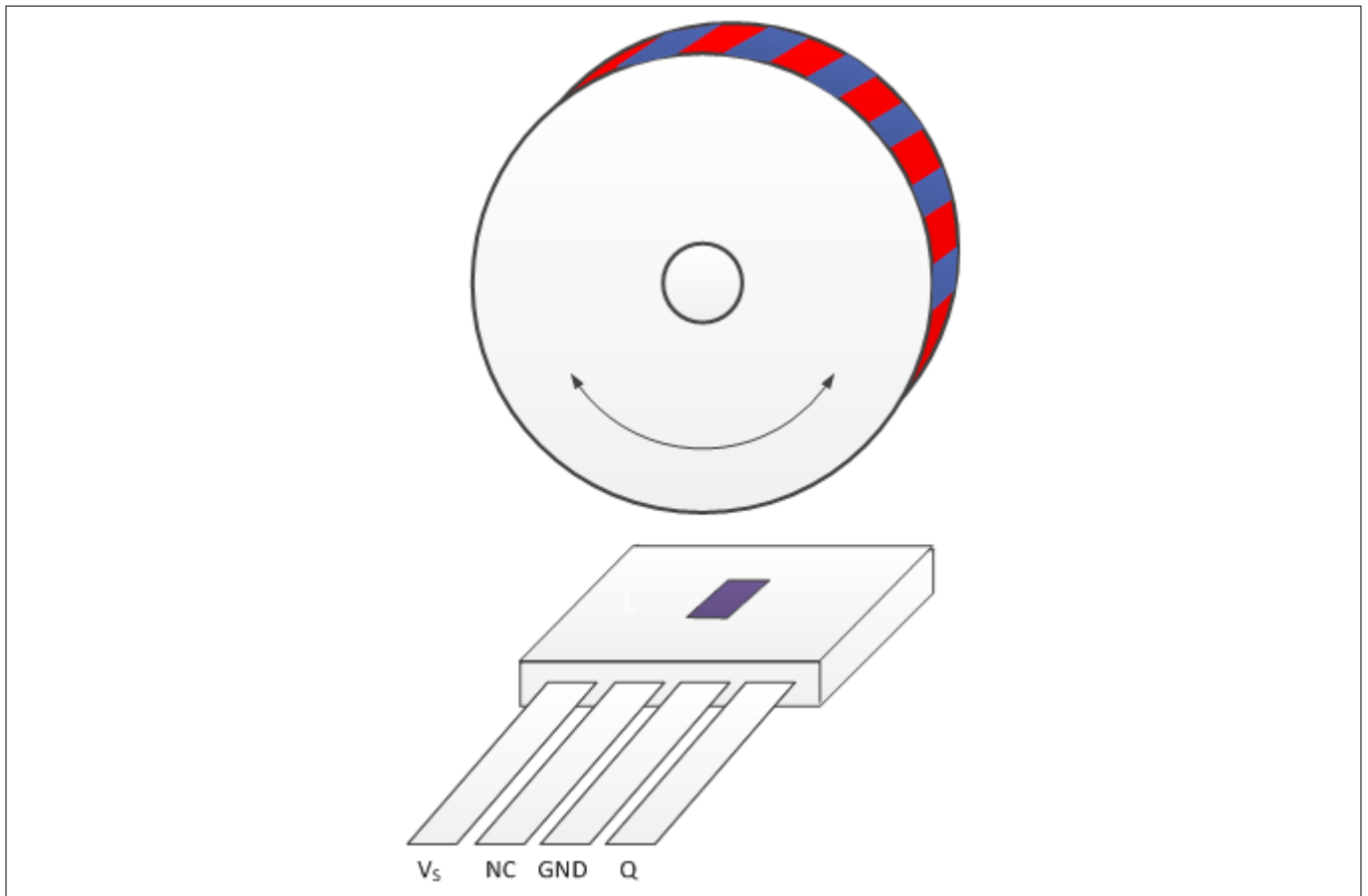

Figure 41 Magnetic encoder wheel

6 Revision History

6 Revision History

Revision History: 2020-06-15, V 1.1

Previous Revision: V1.0

Page	Subjects (major changes since last revision)
25, 26, 27	Changed name of evaluation kit to TLE4922 MS2GO
All	Changed template

Trademarks

All referenced product or service names and trademarks are the property of their respective owners.

Edition 2020-06-15

Published by
Infineon Technologies AG
81726 Munich, Germany

© 2020 Infineon Technologies AG
All Rights Reserved.

Do you have a question about any
aspect of this document?
Email: erratum@infineon.com

Document reference
IFX-byh1568033892103

IMPORTANT NOTICE

The information given in this document shall in no event be regarded as a guarantee of conditions or characteristics ("Beschaffheitsgarantie").

With respect to any examples, hints or any typical values stated herein and/or any information regarding the application of the product, Infineon Technologies hereby disclaims any and all warranties and liabilities of any kind, including without limitation warranties of non-infringement of intellectual property rights of any third party.

In addition, any information given in this document is subject to customer's compliance with its obligations stated in this document and any applicable legal requirements, norms and standards concerning customer's products and any use of the product of Infineon Technologies in customer's applications.

The data contained in this document is exclusively intended for technically trained staff. It is the responsibility of customer's technical departments to evaluate the suitability of the product for the intended application and the completeness of the product information given in this document with respect to such application.

WARNINGS

Due to technical requirements products may contain dangerous substances. For information on the types in question please contact your nearest Infineon Technologies office.

Except as otherwise explicitly approved by Infineon Technologies in a written document signed by authorized representatives of Infineon Technologies, Infineon Technologies' products may not be used in any applications where a failure of the product or any consequences of the use thereof can reasonably be expected to result in personal injury.

Looking for pricing, stock, or lifecycle information?

Click below to explore more details on WIN SOURCE:

- ⊖ [View SPEEDTOGOKITTOBO1 on WIN SOURCE](#)
- ⊖ [Infineon Technologies Information](#)

Optimize Your Supply Chain with WIN SOURCE Solutions

- ✓ Global Sourcing Solution
- ✓ Obsolete Management
- ✓ Cost Control Management
- ✓ Shortage Management
- ✓ Alternative Solution
- ✓ Excess Inventory Management