



THE DATASHEET OF SDAF01



Description

The FS2012 mass flow sensor module measures the flow across a sensing surface using the thermo-transfer (calorimetric) principle. The FS2012 is capable of measuring gas or liquid medium.

The FS2012 offers key advantages over other flow solutions. The sensor utilizes series of MEMS thermocouples, which provide excellent signal-to-noise ratio. The solid thermal isolation along with the silicon-carbide film coating offers excellent abrasive wear resistance and long-term reliability.

The high temperature material used in the flow channel housing and base allows for a wide operating temperature.

Wetted materials consist of a glass fiber-reinforced PA66 resin, epoxy, and silicon carbide.

Typical Applications

- Process controls and monitoring
- Oil and gas leak detection
- HVAC and air control systems
- CPAP and respiratory devices
- Liquid dispensing systems

Features

- Gas or liquid mediums
- Robust solid isolation technology
- Resistant to surface contamination
- No cavity to cause clogging
- Resistant to vibration and pressure shock
- Low-power application
- High-temperature flow housing
- Analog output: 0V to 5V
- Digital output: I2C
- Supply voltage: 5V
- Module operating temperature range: 0°C to +85°C
- 52.8 x 24.0 mm module with 6-pin header

FS2012 Flow Sensor Module

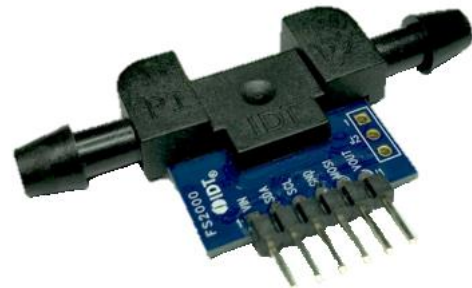

Contents

1. Pin Assignments.....	3
2. Pin Descriptions.....	3
3. Absolute Maximum Ratings.....	4
4. Operating Conditions.....	4
5. Electrical Characteristics.....	5
6. Functional Description.....	6
7. I2C Sensor Interface.....	6
7.1 Sensor Slave Address.....	6
7.2 Data Read.....	6
8. Calculating Flow Sensor Output.....	6
9. Analog Output.....	7
10. Package Drawings and Land Pattern.....	8
11. Ordering Information.....	8
12. Revision History.....	9

List of Figures

Figure 1. Pin Assignments for Module – Top View.....	3
Figure 2. Analog Output Example.....	7

List of Tables

Table 1. Pin Descriptions.....	3
Table 2. Absolute Maximum Ratings.....	4
Table 3. Operating Conditions.....	4
Table 4. Electrical Characteristics.....	5

1. Pin Assignments

Figure 1. Pin Assignments for Module – Top View

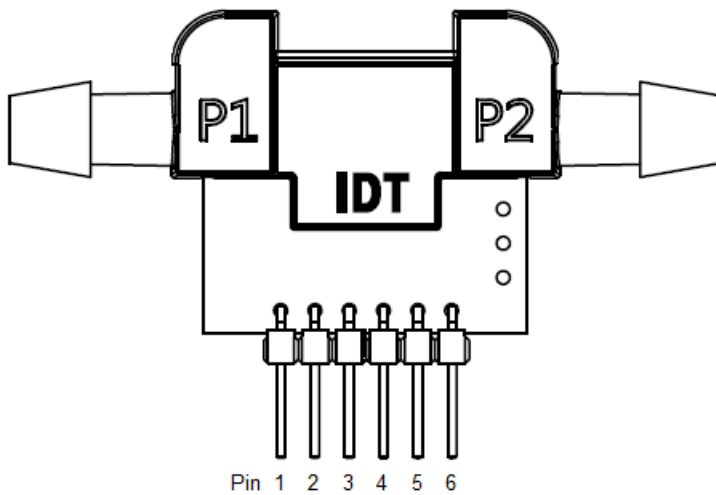

2. Pin Descriptions

Table 1. Pin Descriptions

Pin Number	Pad Name	Type	Description
1	V _{IN}	Input	Supply voltage
2	SDA	Input/Output	Serial data
3	SCL	Input	Serial clock
4	GND	Ground	Ground
5	MOSI		Do not connect
6	V _{OUT}	Output	Analog output

3. Absolute Maximum Ratings

The absolute maximum ratings are stress ratings only. Stresses greater than those listed below can cause permanent damage to the device. Functional operation of the FS2012 at absolute maximum ratings is not implied. Exposure to absolute maximum rating conditions may affect device reliability.

Table 2. Absolute Maximum Ratings

Symbol	Parameter	Conditions	Minimum	Maximum	Units
V _{IN}	Supply Voltage		-0.3	5.5	V
T _{STOR}	Storage Temperature		-50	130	°C
P _{BURST}	Burst Pressure			10	bar

4. Operating Conditions

Table 3. Operating Conditions

Symbol	Parameter	Minimum	Typical	Maximum	Units
V _{IN}	Supply Voltage	4.75	5.0	5.25	V
T _{AMB}	Ambient Operating Temperature	0	–	85	°C

5. Electrical Characteristics

Table 4. Electrical Characteristics

Note: See important notes at the end of the table.

Symbol	Parameter	Conditions	Minimum	Typical	Maximum	Units
I _{VIN}	Current Consumption			30		mA
Gas Flow ^{[a], [c], [d], [d]}						
F _{NG}	Gas Flow Range	FS2012-1020-NG	0.015		2 (2000)	SLPM (SCCM)
		FS2012-1100-NG	0.015		10 (10000)	SLPM (SCCM)
E _{NG}	Flow Accuracy	FS2012-1020-NG; 0.2 to 2 SLPM, at 25°C		±2	±5	% Reading
		FS2012-1100-NG; 1 to 10 SLPM, at 25°C				
V _{OUT_ANG}	Analog Voltage Output	Min to Max of Flow Range	0	—	5	V
OFF _{ZERO_NG}	Analog Zero Offset		0.03	0.045	0.05	V
t _{SAMPLE_G}	Gas Sample Rate	Per measurement		0.4096		Sec
Liquid Flow ^{[a], [b], [c], [d], [d]}						
F _{LQ}	Liquid Flow	FS2012-1001-LQ	0.025		0.5 (500)	SLPM (SCCM)
		FS2012-1002-LQ	0.025		1.0 (1000)	SLPM (SCCM)
E _{LQ}	Flow Accuracy	FS2012-1001-LQ; 25 to 500 SCCM, at 25°C		±2	±6	% Reading
		FS2012-1002-LQ; 50 to 1000 SCCM, at 25°C				
V _{OUT_ALQ}	Analog Voltage Output	Min to Max of Flow Range	0	—	5	V
OFF _{ZERO_LQ}	Zero Offset		0.03	0.045	0.05	V
t _{SAMPLE_L}	Liquid Sample Rate	Per measurement		0.7168		Sec

[a] Direction of flow is from P1 In to P2 Out.

[b] Board circuitry is not protected from liquids.

[c] SLPM: Standard liter per minute.

[d] SCCM: Standard cubic centimeter per minute.

[e] Standard Flow Controller Reference: 25°C, 1atm.

6. Functional Description

The FS2012 digital flow sensor accurately measures the mass flow rate of a liquid or gaseous medium across the sensor using the calorimetric principle.

The MEMS flow sensor comprises a resistive heater and two clusters of thermocouples (thermopiles), each positioned symmetrically upstream and downstream of the heater. The thermopile output changes according to the rate of flow, and it is proportional to the amount of heat sensed from the heater.

7. I2C Sensor Interface

The FS2012 operates as a slave device via the digital I2C compatible communication protocol bus with support for 100kHz and 400kHz bit rates. To accommodate multiple devices, the protocol uses two bi-directional open-drain lines: a Serial Data Line (SDA) and a Serial Clock Line (SCL). Pull-up resistors to VDD are required. Several slave devices can share the bus, and multiple master devices on the same bus are supported. If two or more masters attempt to initiate a data transfer simultaneously, an arbitration scheme is employed with a single master always winning the arbitration. Note that it is not necessary to specify one device as the master in a system; any device that transmits a START bit and a slave address becomes the master for the duration of that transfer.

7.1 Sensor Slave Address

The FS2012 default I2C address is 07_{HEX}. The device will respond only to this address.

7.2 Data Read

The FS2012 is programmed to continuously output data to the I2C bus.

- Number of bytes to read out: 2
- First returned byte: MSB
- Second returned byte: LSB

8. Calculating Flow Sensor Output

The entire output of the FS2012 is 2 bytes. The flow rate for gas and liquid parts is calculated as follows:

Output Data

- Number of bytes to read out: 2
- First returned byte: MSB
- Second returned byte: LSB

Gas Part Configurations (-NG ending for part code number)

- Conversion to SLPM
- Flow in SLPM = [(MSB << 8) + LSB] / 1000

Liquid Part Configurations (-LQ ending for part code number)

- Conversion to SCCM
- Flow in SCCM = [(MSB << 8) + LSB] / 10

Example:

Output data = 1F 2A (hex)

Then = (1F + 2A) = 1F2A = 7978 (decimal)

Flow (Liquid) = 7978/10 = 797.80 SCCM

9. Analog Output

The voltage output is ratiometric to the full scale span. Use the following conversion for the range examples.

Gas (SLPM)

Typical $OFF_{ZERO_NG} = 0.045V$

- 0 to 2 SLPM: Flow = $0.4 \times [Output (V) - OFF_{ZERO_NG}]$
- 0 to 10 SLPM: Flow = $2 \times [Output (V) - OFF_{ZERO_NG}]$

Liquid (SCCM)

Typical $OFF_{ZERO_LQ} = 0.045V$

- 0 to 500 SCCM: Flow = $100 \times [Output (V) - OFF_{ZERO_LQ}]$
- 0 to 1000 SCCM: Flow = $200 \times [Output (V) - OFF_{ZERO_LQ}]$

Figure 2. Analog Output Example

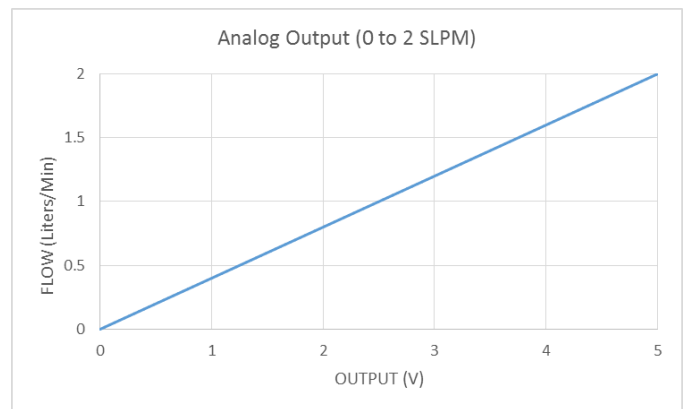
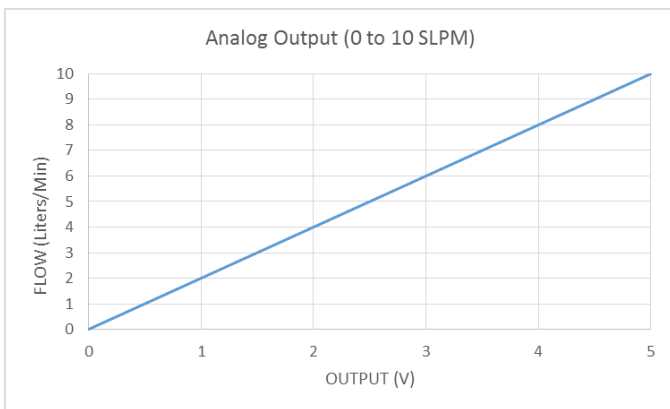

10. Package Drawings and Land Pattern

The package outline drawings are appended at the end of this document and are accessible from the link below. The package information is the most current data available.

<https://www.idt.com/document/psc/fs2012-package-outline-drawing-5280-x-3317-mm-body-254-mm-pitch-mod0>

11. Ordering Information

Note: The part code depends on the application. In the part code, NG refers to “non-corrosive gas” and LQ refers to “liquid.”

- For NG parts, the calibration gas is nitrogen. Other calibration gases are available on request.
- For LQ parts, the calibration fluid is DI water.

Orderable Part Number	Description and Package	Carrier Type	Temperature
FS2012-1020-NG	0 to 2 SLPM calibrated gas flow sensor mounted on a circuit board with a flow housing; digital I2C and analog output	Box	0°C to +85°C
FS2012-1100-NG	0 to 10 SLPM calibrated gas flow sensor mounted on a circuit board with a flow housing; digital I2C and analog output	Box	0°C to +85°C
FS2012-1001-LQ	0 to 0.5 SLPM (500 SCCM) calibrated liquid flow sensor mounted on a circuit board with a flow housing; digital I2C and analog output	Box	0°C to +85°C
FS2012-1002-LQ	0 to 1.0 SLPM (1000 SCCM) calibrated liquid flow sensor mounted on a circuit board with a flow housing; digital I2C and analog output	Box	0°C to +85°C

12. Revision History

Revision Date	Description of Change
August 24, 2018	<ul style="list-style-type: none"> ▪ Update for Table 4. ▪ Update for module drawing. ▪ Add flow calculation example. ▪ Minor edits .
September 11, 2017	<ul style="list-style-type: none"> ▪ Update for module width on page 1. ▪ Update for module dimensions drawing. ▪ Update for Table 4.
July 19, 2017	Initial release of the preliminary datasheet.

IMPORTANT NOTICE AND DISCLAIMER

RENESAS ELECTRONICS CORPORATION AND ITS SUBSIDIARIES (“RENESAS”) PROVIDES TECHNICAL SPECIFICATIONS AND RELIABILITY DATA (INCLUDING DATASHEETS), DESIGN RESOURCES (INCLUDING REFERENCE DESIGNS), APPLICATION OR OTHER DESIGN ADVICE, WEB TOOLS, SAFETY INFORMATION, AND OTHER RESOURCES “AS IS” AND WITH ALL FAULTS, AND DISCLAIMS ALL WARRANTIES, EXPRESS OR IMPLIED, INCLUDING, WITHOUT LIMITATION, ANY IMPLIED WARRANTIES OF MERCHANTABILITY, FITNESS FOR A PARTICULAR PURPOSE, OR NON-INFRINGEMENT OF THIRD-PARTY INTELLECTUAL PROPERTY RIGHTS.

These resources are intended for developers who are designing with Renesas products. You are solely responsible for (1) selecting the appropriate products for your application, (2) designing, validating, and testing your application, and (3) ensuring your application meets applicable standards, and any other safety, security, or other requirements. These resources are subject to change without notice. Renesas grants you permission to use these resources only to develop an application that uses Renesas products. Other reproduction or use of these resources is strictly prohibited. No license is granted to any other Renesas intellectual property or to any third-party intellectual property. Renesas disclaims responsibility for, and you will fully indemnify Renesas and its representatives against, any claims, damages, costs, losses, or liabilities arising from your use of these resources. Renesas' products are provided only subject to Renesas' Terms and Conditions of Sale or other applicable terms agreed to in writing. No use of any Renesas resources expands or otherwise alters any applicable warranties or warranty disclaimers for these products.

(Disclaimer Rev.1.01 Jan 2024)

Corporate Headquarters

TOYOSU FORESIA, 3-2-24 Toyosu,
Koto-ku, Tokyo 135-0061, Japan
www.renesas.com

Trademarks

Renesas and the Renesas logo are trademarks of Renesas Electronics Corporation. All trademarks and registered trademarks are the property of their respective owners.

Contact Information

For further information on a product, technology, the most up-to-date version of a document, or your nearest sales office, please visit www.renesas.com/contact-us/.

Looking for pricing, stock, or lifecycle information?

Click below to explore more details on WIN SOURCE:

- ⊖ [View SDAF01 on WIN SOURCE](#)
- ⊖ [Renesas Electronics America](#) Information

Optimize Your Supply Chain with WIN SOURCE Solutions

- ✓ Global Sourcing Solution
- ✓ Obsolete Management
- ✓ Cost Control Management
- ✓ Shortage Management
- ✓ Alternative Solution
- ✓ Excess Inventory Management