



## Si1000 AND Si1010 DEVELOPMENT KIT USER'S GUIDE

### 1. Relevant Devices

The Si1000 and Si1010 Development Kits are intended as development platforms for the microcontrollers in the Si100x and Si101x MCU family, respectively. The members of these MCU families include Si1000, Si1001, Si1002, Si1003, Si1004, Si1005, Si1010, Si1011, Si1012, Si1013, Si1014, and Si1015. Each kit consists of a motherboard and daughtercard. The daughtercard included in the kit is configured for high band (868/915 MHz) and up to +20 dBm transmit power. Additional daughtercards may be purchased separately for low band or low transmit power applications.

### 2. Kit Contents

The Si1000 and Si1010 Development Kit contains the following items:

- Si1000 motherboard which supports all Si10xx series daughtercards
- Si1000 or Si1010 daughtercard (Si1000 or Si1010 MCU pre-soldered on the daughtercard)
- Si10xx Development Kit Quick-Start Guide
- Silicon Laboratories IDE and Product Information CD-ROM. CD content includes the following:
  - Silicon Laboratories Integrated Development Environment (IDE)
  - Keil 8051 Development Tools (macro assembler, linker, evaluation C compiler)
  - Source code examples and register definition files
  - Documentation
  - Si1000 and Si1010 Development Kit User's Guide (this document)
- AC to DC Power Adapter
- USB Debug Adapter (USB to Debug Interface)
- 2 USB cables
- 2 AAA batteries



Figure 1. Si1000 Motherboard with Si1000 Daughtercard

# Si10xx-DK

---

## 3. Software Overview

All software required to develop firmware and communicate with the target microcontroller is included in the CD-ROM. The CD-ROM also includes other useful software.

Below is the software necessary for firmware development and communication with the target microcontroller:

- Silicon Laboratories Integrated Development Environment (IDE)
- Keil 8051 Development Tools (macro assembler, linker, evaluation C compiler)

Other useful software that is provided in the CD-ROM includes the following:

- Configuration Wizard 2
- Keil  $\mu$ Vision Drivers
- CP210x USB to UART Virtual COM Port (VCP) Drivers

### 3.1. Software Installation

The included CD-ROM contains the Silicon Laboratories Integrated Development Environment (IDE), Keil software 8051 tools and additional documentation. Insert the CD-ROM into your PC's CD-ROM drive. An installer will automatically launch allowing you to install the IDE software or read documentation by clicking buttons on the Installation Panel. If the installer does not automatically start when you insert the CD-ROM, run *autorun.exe* found in the root directory of the CD-ROM. Refer to the *ReleaseNotes.txt* file on the CD-ROM for the latest information regarding known problems and restrictions. After installing the software, see the following sections for information regarding the software and running one of the demo applications.

### 3.2. CP210x USB to UART VCP Driver Installation

The Si10xx Target Board includes a Silicon Laboratories CP2103 USB-to-UART Bridge Controller. Device drivers for the CP2103 need to be installed before PC software such as HyperTerminal can communicate with the target board over the USB connection. If the "Install CP210x Drivers" option was selected during installation, this will launch a driver "unpacker" utility.

1. Follow the steps to copy the driver files to the desired location. The default directory is *C:\SiLabs\MCU\CP210x*.
2. The final window will give an option to install the driver on the target system. Select the "Launch the CP210x VCP Driver Installer" option if you are ready to install the driver.
3. If selected, the driver installer will now launch, providing an option to specify the driver installation location. After pressing the "Install" button, the installer will search your system for copies of previously installed CP210x Virtual COM Port drivers. It will let you know when your system is up to date. The driver files included in this installation have been certified by Microsoft.
4. If the "Launch the CP210x VCP Driver Installer" option was not selected in step 3, the installer can be found in the location specified in step 2, by default *C:\SiLabs\MCU\CP210x\Windows\_2K\_XP\_S2K3\_Vista*. At this location run *CP210xVCPInstaller.exe*.
5. To complete the installation process, connect the included USB cable between the host computer and the USB connector (P3) on the Si10xx Target Board. Windows will automatically finish the driver installation. Information windows will pop up from the taskbar to show the installation progress.
6. If needed, the driver files can be uninstalled by selecting "Silicon Laboratories CP210x USB to UART Bridge (Driver Removal)" option in the "Add or Remove Programs" window.

### 3.3. Silicon Laboratories IDE

The Silicon Laboratories IDE integrates a source-code editor, a source-level debugger, and an in-system Flash programmer. See Section 5. "Using the Keil Software 8051 Tools with the Silicon Laboratories IDE," on page 8 for detailed information on how to use the IDE. The Keil Evaluation Toolset includes a compiler, linker, and assembler and easily integrates into the IDE. The use of third-party compilers and assemblers is also supported.

#### 3.3.1. IDE System Requirements

The Silicon Laboratories IDE requirements:

- Pentium-class host PC running Microsoft Windows 2000 or newer
- One available USB port
- 64 MB RAM and 40 MB free HD space recommended

### 3.3.2. 3rd Party Toolsets

The Silicon Laboratories IDE has native support for many 8051 compilers. The full list of natively supported tools is as follows:

- Keil
- IAR
- Raisonance
- Tasking
- Hi-Tech
- SDCC

The demo applications for the Si10xx target board are written to work with the Keil and SDCC toolsets.

## 3.4. Keil Evaluation Toolset

### 3.4.1. Keil Assembler and Linker

The Keil demonstration toolset assembler and linker place no restrictions on code size.

### 3.4.2. Keil Evaluation C51 C Compiler

The evaluation version of the C51 compiler is the same as the full version with the following limitations: Maximum 4 kB code generation, and there is no floating point library included. When installed from the CD-ROM, the C51 compiler is initially limited to a code size of 2 kB, and programs start at code address 0x0800. Refer to "AN104: Integrating Keil Tools into the Silicon Labs IDE" for instructions to change the limitation to 4 kB and have the programs start at code address 0x0000.

## 3.5. Configuration Wizard 2

The Configuration Wizard 2 is a code generation tool for all of the Silicon Laboratories devices. Code is generated through the use of dialog boxes for each of the device's peripherals.

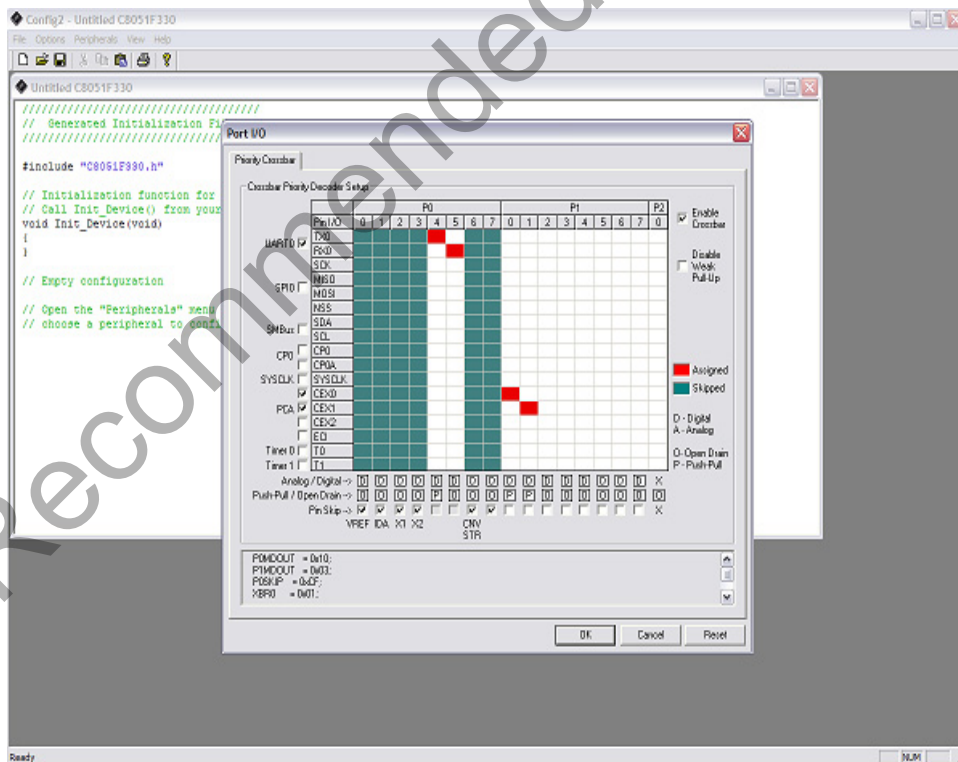

Figure 2. Configuration Wizard 2 Utility

# Si10xx-DK

The Configuration Wizard utility helps accelerate development by automatically generating initialization source code to configure and enable the on-chip resources needed by most design projects. In just a few steps, the wizard creates complete startup code for a specific Silicon Laboratories MCU. The program is configurable to provide the output in C or assembly language. For more information, refer to the Configuration Wizard documentation. Documentation and software is available on the kit CD and from the downloads webpage: [www.silabs.com/mcudownloads](http://www.silabs.com/mcudownloads).

## 3.6. Silicon Labs Battery Life Estimator

The Battery Life Estimator is a system design tool for battery operated devices. It allows the user to select the type of battery they are using in the system and enter the supply current profile of their application. Using this information, it performs a simulation and provides an estimated system operating time. The Battery Life Estimator is shown in Figure 3.

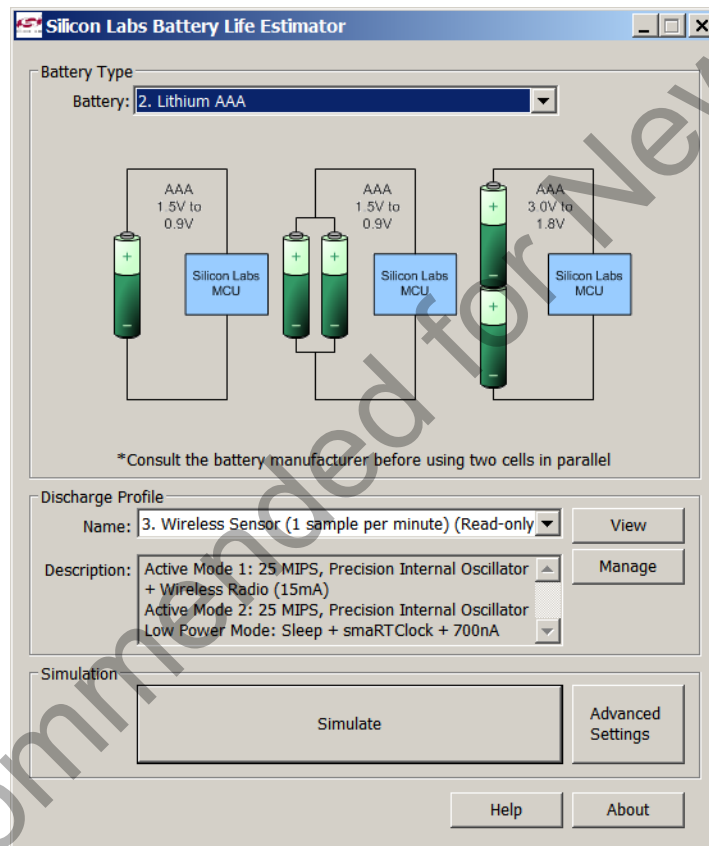

**Figure 3. Battery Life Estimator Utility**

From Figure 3, the two inputs to the Battery Life Estimator are battery type and discharge profile. The utility includes battery profiles for common battery types such as AAA, AA, A76 Button Cell, and CR2032 coin cell. The discharge profile is application-specific and describes the supply current requirements of the system under various supply voltages and battery configurations. The discharge profile is independent of the selected power source. Several read-only discharge profiles for common applications are included in the pulldown menu. The user may also create a new profile for their own applications.

To create a new profile:

1. Select the profile that most closely matches the target application or choose the "Custom Profile".
2. Click Manage
3. Click Duplicate
4. Click Edit

Profiles may be edited with the easy-to-use GUI (shown in Figure 4).

Discharge Profile

Name: 9. Custom Profile

Description: Custom Application Profile

Minimum System Operating Voltage

Minimum Voltage: 1.8 v

Voltage

V2: 2.2 v V1: 3 v

Active Mode 1

Time: 1000 us VDD/DC+ Supply Current @ V2: 10000 uA VDD/DC+ Supply Current @ V1: 10000 uA

Active Mode 2

Time: 0 us VDD/DC+ Supply Current @ V2: 0 uA VDD/DC+ Supply Current @ V1: 0 uA

Idle Mode

Time: 0 us VDD/DC+ Supply Current @ V2: 0 uA VDD/DC+ Supply Current @ V1: 0 uA

Sleep Mode

Time: 0 ms Calculate VBAT Supply Current @ V2: 0 uA VBAT Supply Current @ V1: 0 uA

Wake Up Frequency

Frequency: 1000 Wake Events / Second

OK Cancel

**Figure 4. Battery Life Estimator Discharge Profile Editor**

The Discharge Profile Editor allows the user to modify the profile name and description. The four text entry boxes on the left hand side of the form allow the user to specify the amount of time the system spends in each power mode. On the right hand side, the user may specify the supply current of the system in each power mode.

# Si10xx-DK

Since supply current is typically dependent on supply voltage, the discharge profile editor provides two columns for supply current. The V2 and V1 voltages at the top of the two columns specify the voltages at which the current measurements were taken. The Battery Life Estimator creates a linear approximation based on the input data and is able to feed the simulation engine with an approximate supply current demand for every input voltage.

The minimum system operating voltage input field allows the system operating time to stop increasing when the simulated battery voltage drops below a certain threshold. This is primarily to allow operating time estimates for systems that cannot operate down to 1.8 V, which is the voltage of two fully drained single-cell batteries placed in series.

The wakeup frequency box calculates the period of a single iteration through the four power modes and displays the system wake up frequency. This is typically the "sample rate" in low power analog sensors.

Once the battery type and discharge profile is specified, the user can click the "Simulate" button to start a new simulation. The simulation engine calculates the estimated battery life when using one single-cell battery, two single-cell batteries in series, and two single-cell batteries in parallel. Figure 5 shows the simulation output window.

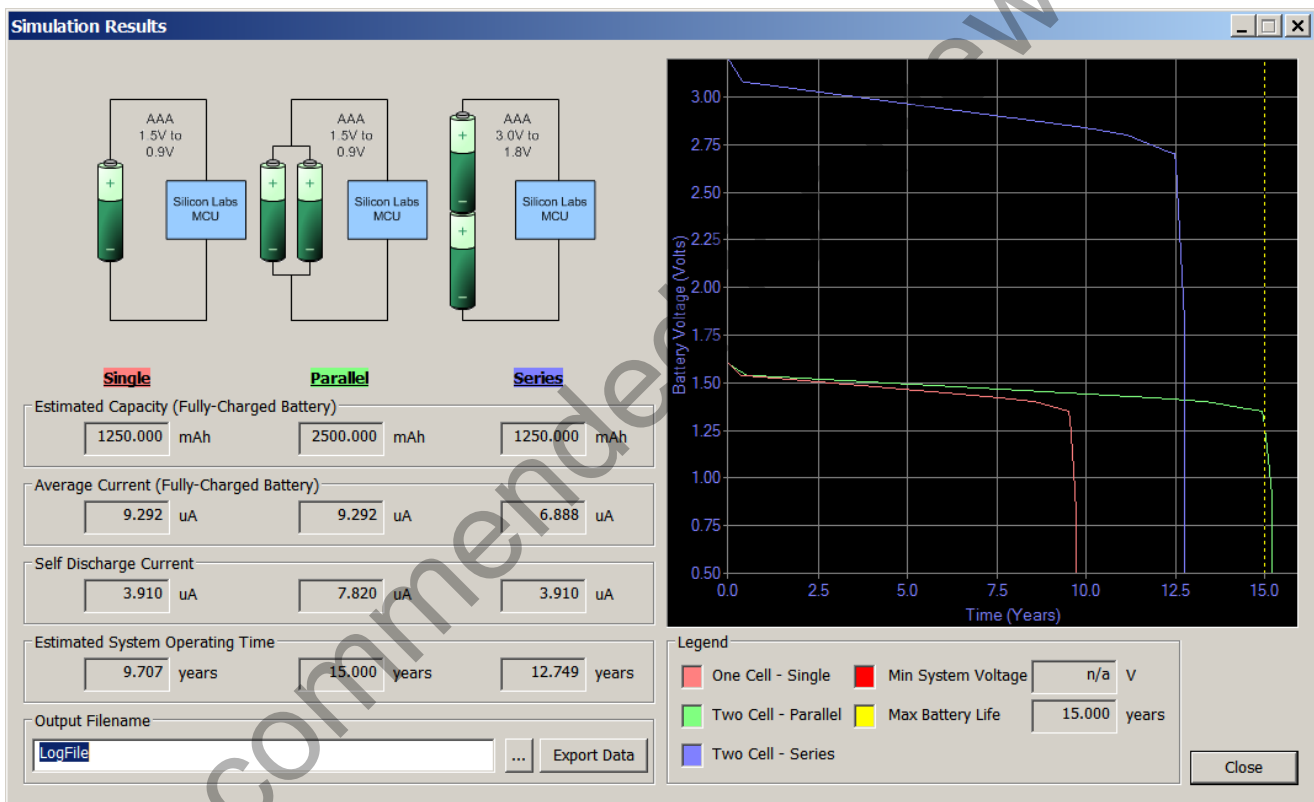

Figure 5. Battery Life Estimator Utility Simulation Results Form

The primary outputs of the Battery Life Estimator are an estimated system operating time and a simulated graph of battery voltage vs. time. Additional outputs include estimated battery capacity, average current, self-discharge current, and the ability to export graph data to a comma delimited text file for plotting in an external graphing application.

### 3.7. Keil $\mu$ Vision2 and $\mu$ Vision3 Silicon Laboratories Drivers

As an alternative to the Silicon Laboratories IDE, the  $\mu$ Vision debug driver allows the Keil  $\mu$ Vision2 and  $\mu$ Vision3 IDEs to communicate with Silicon Laboratories' on-chip debug logic. In-system Flash memory programming integrated into the driver allows for rapid updating of target code. The  $\mu$ Vision2 and  $\mu$ Vision3 IDEs can be used to start and stop program execution, set breakpoints, check variables, inspect and modify memory contents, and single-step through programs running on the actual target hardware. For more information, refer to the  $\mu$ Vision driver documentation. The documentation and software are available on the kit CD and from the downloads webpage: [www.silabs.com/mcudownloads](http://www.silabs.com/mcudownloads).

## 4. Hardware Setup using a USB Debug Adapter

The motherboard is connected to a PC running the Silicon Laboratories IDE via the USB Debug Adapter as shown in Figure 6.

1. Connect the USB Debug Adapter to the DEBUG connector on the motherboard with the 10-pin ribbon cable.
2. Connect one end of the USB cable to the USB connector on the USB Debug Adapter.
3. Verify that a shorting block is installed on J17 and that SW5 is in the ON position.
4. Connect the other end of the USB cable to a USB Port on the PC.
5. Connect the ac/dc power adapter to power jack P1 on the target board (Optional).

#### Notes:

- Use the Reset button in the IDE to reset the target when connected using a USB Debug Adapter.
- Remove power from the target board and the USB Debug Adapter before connecting or disconnecting the ribbon cable from the target board. Connecting or disconnecting the cable when the devices have power can damage the device and/or the USB Debug Adapter.

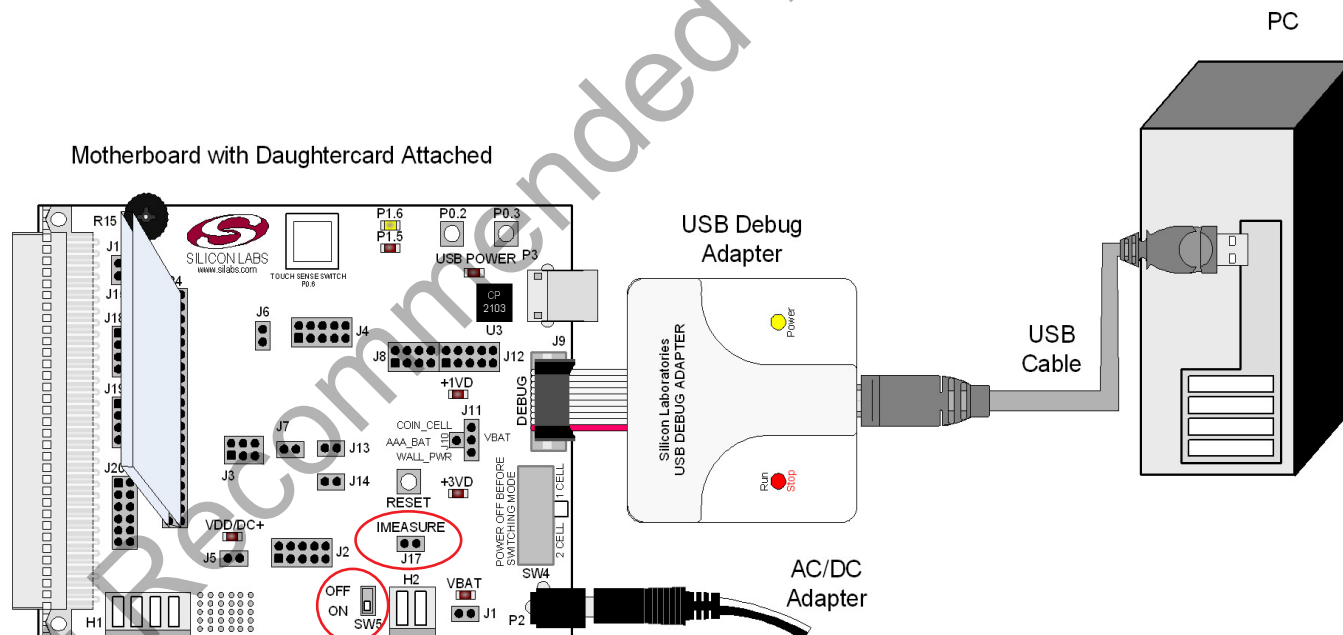

Figure 6. Hardware Setup using a USB Debug Adapter

## 5. Using the Keil Software 8051 Tools with the Silicon Laboratories IDE

To perform source-level debugging with the IDE, configure the Keil 8051 tools to generate an absolute object file in the OMF-51 format with object extensions and debug records enabled. Build the OMF-51 absolute object file by calling the Keil 8051 tools at the command line (e.g., batch file or make file) or by using the project manager built into the IDE. The default configuration when using the Silicon Laboratories IDE project manager enables object extension and debug record generation. Refer to "AN104: Integrating Keil 8051 Tools into the Silicon Labs IDE" in the "*SiLabs\MCU\Documentation\ApplicationNotes*" directory on the CD-ROM for additional information on using the Keil 8051 tools with the Silicon Laboratories IDE.

To build an absolute object file using the Silicon Laboratories IDE project manager, you must first create a project. A project consists of a set of files, IDE configuration, debug views, and a target build configuration (list of files and tool configurations used as input to the assembler, compiler, and linker when building an output object file).

The following sections illustrate the steps necessary to manually create a project with one or more source files, build a program, and download it to the target in preparation for debugging. (The IDE will automatically create a single-file project using the currently open and active source file if you select Build/Make Project before a project is defined.)

### 5.1. Creating a New Project

1. Select Project→New Project to open a new project and reset all configuration settings to default.
2. Select File→New File to open an editor window. Create your source file(s) and save the file(s) with a recognized extension, such as .c, .h, or .asm, to enable color syntax highlighting.
3. Right-click on "New Project" in the Project Window. Select Add files to project. Select files in the file browser and click Open. Continue adding files until all project files have been added.
4. For each of the files in the Project Window that you want assembled, compiled and linked into the target build, right-click on the file name and select Add file to build. Each file will be assembled or compiled as appropriate (based on file extension) and linked into the build of the absolute object file.
5. If a project contains a large number of files, the "Group" feature of the IDE can be used to organize. Right-click on "New Project" in the Project Window. Select Add Groups to project. Add pre-defined groups or add customized groups. Right-click on the group name and choose Add file to group. Select files to be added. Continue adding files until all project files have been added.

### 5.2. Building and Downloading the Program for Debugging

1. Once all source files have been added to the target build, build the project by clicking on the Build/Make Project button in the toolbar or selecting Project→Build/Make Project from the menu.

**Note:** After the project has been built the first time, the Build/Make Project command will only build the files that have been changed since the previous build. To rebuild all files and project dependencies, click on the Rebuild All button in the toolbar or select Project→Rebuild All from the menu.

2. Before connecting to the target device, several connection options may need to be set. Open the Connection Options window by selecting Options→Connection Options... in the IDE menu. First, select the appropriate adapter in the "Serial Adapter" section. Next, the correct "Debug Interface" must be selected. Si100x-Si101x family devices use the Silicon Labs 2-wire (C2) debug interface. Once all the selections are made, click the OK button to close the window.
3. Click the Connect button in the toolbar or select Debug→Connect from the menu to connect to the device.
4. Download the project to the target by clicking the Download Code button in the toolbar.

**Note:** To enable automatic downloading if the program build is successful select Enable automatic connect/download after build in the Project→Target Build Configuration dialog. If errors occur during the build process, the IDE will not attempt the download.

5. Save the project when finished with the debug session to preserve the current target build configuration, editor settings and the location of all open debug views. To save the project, select Project→Save Project As... from the menu. Create a new name for the project and click on Save.

## 6. Example Source Code

Example source code and register definition files are provided in the “*SiLabs\MCU\Examples\Si100x*” or the “*SiLabs\MCU\Examples\Si101x*” default directory during IDE installation. These files may be used as a template for code development. Example applications include a blinking LED example which configures the LED on the motherboard to blink at a fixed rate.

### 6.1. Register Definition Files

Register definition files *Si1000\_defs.h* and *Si1010\_defs.h* define all SFR registers and bit-addressable control/status bits. A macro definition header file *compiler\_defs.h* is also included, and is required to be able to use the *Si1000* and *Si1010\_defs.h* header file with various tool chains. These files are installed into the “*SiLabs\MCU\Examples\Si100x\Header\_Files*” and “*SiLabs\MCU\Examples\Si101x\Header\_Files*” directories during IDE installation by default. The register and bit names are identical to those used in the Si100x and Si101x data sheets. These register definition files are also installed in the default search path used by the Keil Software 8051 tools. Therefore, when using the Keil 8051 tools included with the development kit (A51, C51), it is not necessary to copy a register definition file to each project’s file directory.

### 6.2. Blinking LED Example

The example source files *Si100x\_Blinky.asm* and *Si101x\_Blinky.c* installed in the default directories “*SiLabs\MCU\Examples\Si100x\Blinky*” and “*SiLabs\MCU\Examples\Si101x\Blinky*” show examples of several basic MCU functions. These include disabling the watchdog timer (WDT), configuring the Port I/O crossbar, configuring a timer for an interrupt routine, initializing the system clock, and configuring a GPIO port pin. When compiled/assembled and linked this program flashes the LED on the Si1000 Motherboard about five times a second using the interrupt handler with an on-chip timer.

### 6.3. RF Examples

The Si100x and Si101x MCUs support RF communication. Examples of RF communication using the Si100x and Si101x products are described in Application Note AN474. The source code for the RF examples is installed into the “*SiLabs\MCU\Examples\Si100x\EZRadioPRO*” and “*SiLabs\MCU\Examples\Si101x\EZRadioPRO*” during IDE installation. The most basic example is the TxTone example. When downloaded and run on the MCU, a 915 MHz tone will be generated from the EZRadioPRO peripheral output.

## 7. Using the Si1000 Motherboard with the Wireless Development Suite

The Si1000 motherboard is supported by the Wireless Development Suite. Some features of the Wireless Development Suite will be disabled when connected to an Si1000 motherboard. See the Wireless Development Suite documentation for details. When using the Wireless Development Suite, the following configurations are required:

- J18 - shorting blocks should be closed if using an Si1000/1/2/3/4/5 device and open otherwise.
- J19 - shorting blocks should be closed if using an Si1010/1/2/3/4/5 device and open otherwise.
- J20 - shorting blocks should be closed
- J12 - 3 shorting blocks (closest to USB connector) should be closed to enable UART communication.

Firmware is currently in development to allow the Si10xx daughtercards to connect to the Wireless Development Suite through the Si1000 Motherboard.

## 8. Using Si10xx Daughtercards with the Wireless Development Suite

To enable all the features of the Wireless Development Suite, the Si10xx daughtercards may be used directly with wireless development suite, without an Si1000 motherboard. The Si10xx daughtercards must be programmed with “pass-through” firmware to make them appear as fixed-function, stand-alone EZRadioPRO devices such as the Si4430/1/2/3. An SDBC-DK3 development kit is required to connect to the Wireless Development Suite in this mode.

To program the Si10xx daughtercards for this mode, download the following hex file to the daughtercard:

For Si100x daughtercards:

C:\Silabs\MCU\Examples\Si100x\EZRadioPRO\SPI\_PassThrough\SPI\_PassThrough.hex

For Si101x daughtercards:

C:\Silabs\MCU\Examples\Si101x\EZRadioPRO\SPI\_PassThrough\SPI\_PassThrough.hex

After the “pass-through” code is downloaded to the daughtercard, it may be used as a standard daughtercard for the SDBC-DK3 development kit. See the SDBC-DK3 documentation for more details.

## 9. Using the Si1000 Motherboard with a CP240x LCD Development Board

The Si1000 motherboard supports the CP2400 and CP2401 development boards for developing LCD applications. When using an LCD development board, the following configurations are required:

- J18 - shorting blocks should be closed if using an Si1000/1/2/3/4/5 device and open otherwise.
- J19 - shorting blocks should be closed if using an Si1010/1/2/3/4/5 device and open otherwise.
- J20 - shorting blocks should be open

When a CP240x development board is connected to the Si1000 motherboard, the Port I/O usage matrix shown in Figure 7 should be used for software development.

Port Pin	Si1000/1/2/3	Si1004/5	Si1010/1/2/3	Si1014/5
P0.0	CP240x /RST			
P0.1	EZRadioPRO_NIRQ			
P0.2	Push Button Switch		CP240x_SCK	
P0.3	Push Button Switch		CP240x_MISO	
P0.4	UART_TX / GPIO			
P0.5	UART_RX / GPIO			
P0.6	Potentiometer Input / CapTouch / GPIO			
P0.7	CP240x /INT			
P1.0	EZRadioPRO_SCK			
P1.1	EZRadioPRO_MISO			
P1.2	EZRadioPRO_MOSI			
P1.3	N.C.	N.C.	EZRadioPRO_NSS	
P1.4	EZRadioPRO_NSS		CP240x_MOSI	
P1.5	LED		CP240x_NSS	
P1.6	LED		EZRadioPRO_SDN	
P1.7	CP240x_SCK			
P2.0	CP240x_MISO			
P2.1	CP240x_MOSI			
P2.2	CP240x_NSS			
P2.3	Reserved	EZRadioPRO_SDN		
P2.4	GPIO			
P2.5	GPIO			
P2.6	EZRadioPRO_SDN			
P2.7	P2.7/C2D			

 Available for use by the application.

 Not Available / Not Bonded Out

Figure 7. Port I/O Usage Matrix

# Si10xx-DK

## 10. Motherboard

The Si1000 and Si1010 Development Kit includes a motherboard that enables evaluation and preliminary software development. Numerous input/output (I/O) connections are provided to facilitate prototyping using the target board. Refer to Figure 8 for the locations of the various I/O connectors. Figure 10 on page 14 shows the factory default shorting block positions.

- P1 Expansion connector (96-pin)
- P2 Power connector (accepts input from 7 to 15 VDC unregulated power adapter)
- P3 USB connector (connects to PC for serial communication)
- J1 Enable/Disable VBAT Power LED
- J2, J3, J4 Port I/O headers (provide access to Port I/O pins)
- J5 Enable/Disable VDD/DC+ Power LED
- J6 Provides an easily accessible ground clip
- J7 Connects pin P0.7 (IREF0 Output) to resistor R14 and capacitor C19
- J8 Connects P0.2 and P0.3 to switches and P1.5 and P1.6 to LEDs
- J9 DEBUG connector for Debug Adapter interface
- J10, J11 Selects the power supply source (Wall Power, AAA Battery, or Coin Cell)
- J12 Connects Port I/O to UART0 interface
- J13 Connects external VREF capacitor to the P0.0/VREF
- J14 Connects the PCB ground plane to P0.1/AGND
- J15 Connects negative potentiometer (R14) terminal to pin P1.4 or to GND
- J16 Connects the potentiometer (R14) wiper to P0.6/CNVSTR
- J17 Creates an open in the power supply path to allow supply current measurement
- J18, J19 Connects signals on P1 to the appropriate GPIO. Short J18 for Si100x and J19 for Si101x.
- J20 Connects signals on J18/J19 to the EEPROM accessible through P4.
- H1 Analog I/O terminal block
- H2 Provides terminal block access to the input and output nodes of J17
- SW4 Switches the device between One-Cell (0.9–1.8 V supply) or Two-Cell (1.8–3.6 V) mode
- SW5 Turns power to the MCU on or off

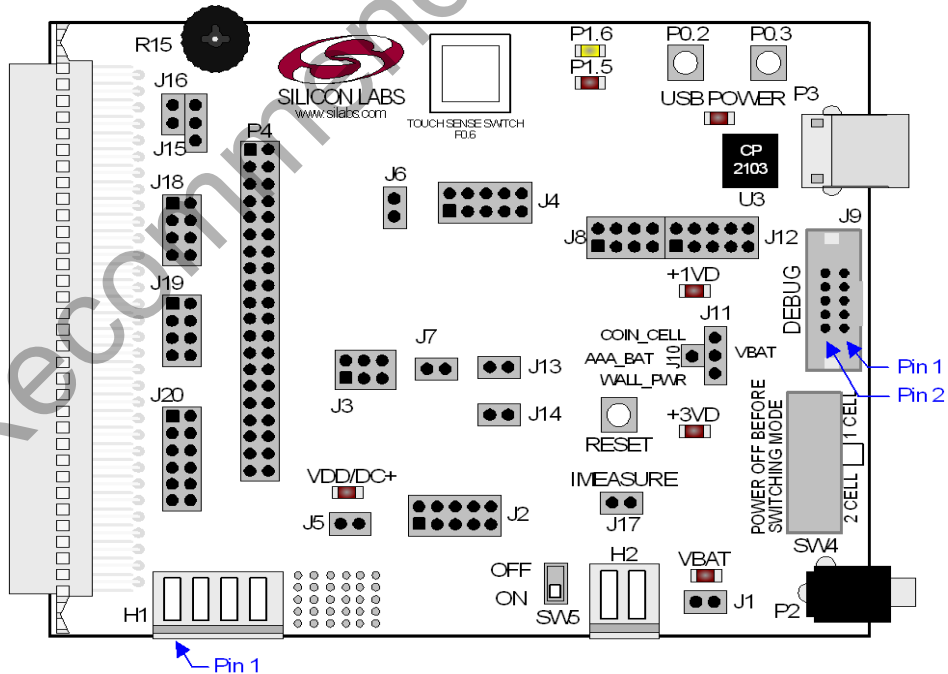

Figure 8. Si1000 Motherboard

The following items are located on the bottom side of the board. See Figure 9.

- BT1 Battery Holder for 1.5 V AAA. Use for one-cell or two-cell mode.
- BT2 Battery Holder for 1.5 V AAA. Use for two-cell mode only.
- BT3 Battery Holder for 3 V Coin Cell (CR2032).
- BT4 Battery Holder for 1.5 V Button Cell (A76 or 357).

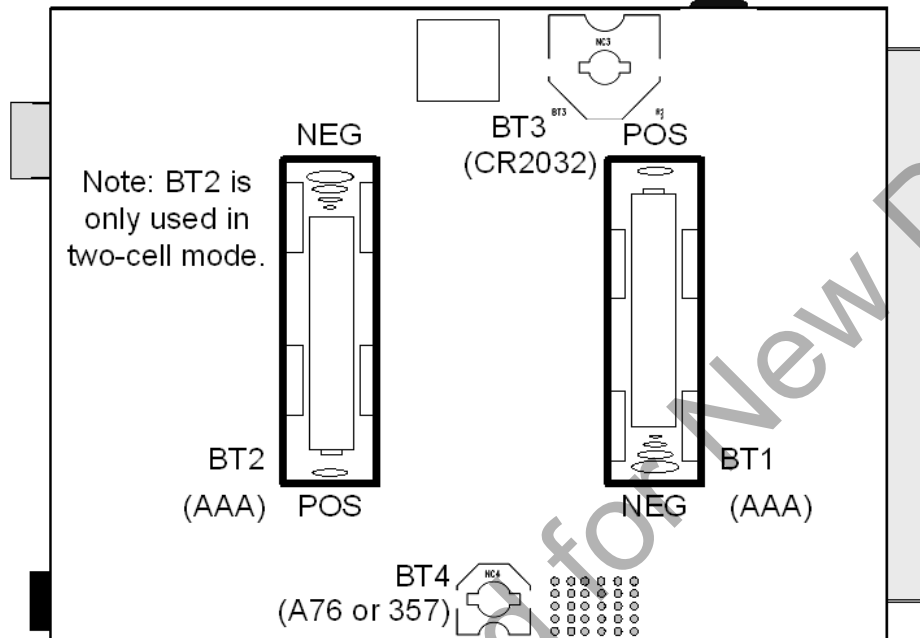

Figure 9. Bottom of Si1000 Motherboard

# Si10xx-DK

## 10.1. Motherboard Shorting Blocks: Factory Defaults

The Si1000 motherboard comes from the factory with pre-installed shorting blocks on many headers. Figure 10 shows the positions of the factory default shorting blocks.

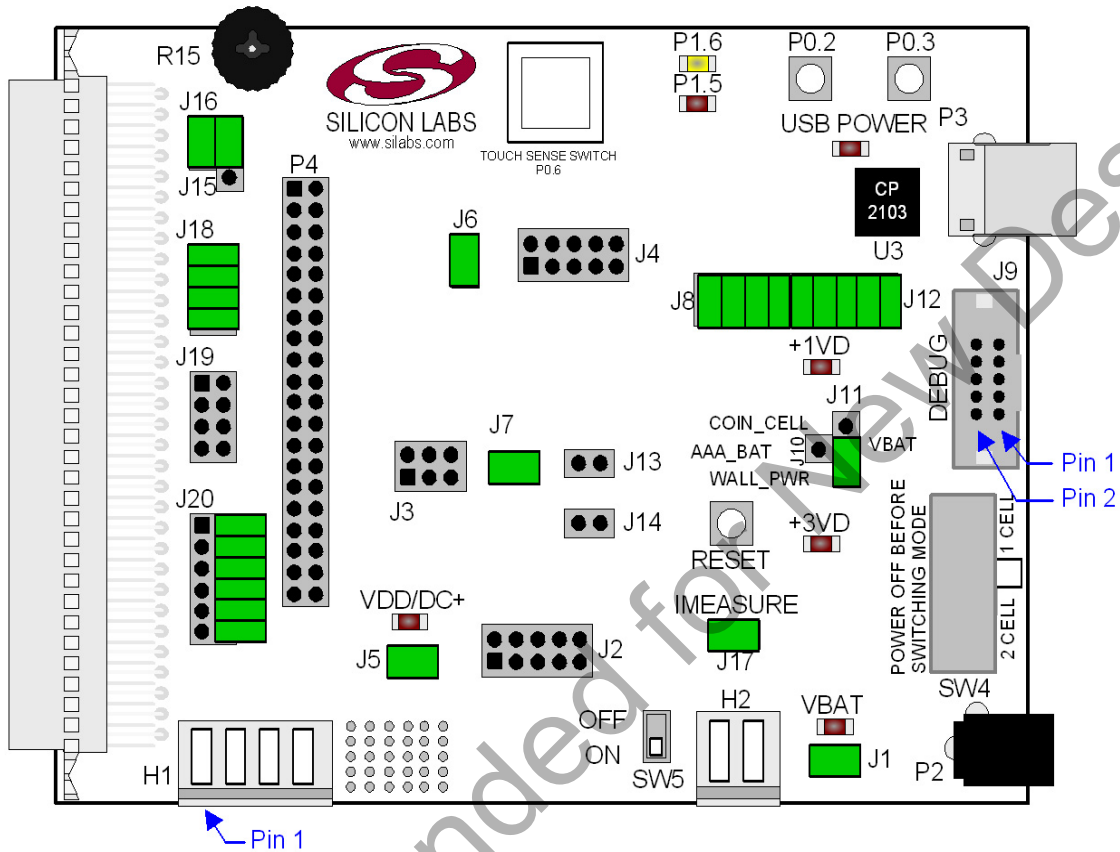

Figure 10. Si1000 Motherboard Shorting Blocks: Factory Defaults

## 10.2. Target Board Power Options and Current Measurement

The Si10xx Target Board supports three power options, selectable by the three-way header (J10/J11). The power options vary based on the configuration (one-cell or two-cell mode) selected by SW4. Power to the MCU may be switched on/off using the power switch (SW5). **Important Note: The power switch (SW5) must be in the OFF position prior to switching between one-cell and two-cell mode using SW4.** The power options are described in the paragraphs below.

### 10.2.1. Wall Power

When the J10/J11 three-way header is set to WALL\_PWR, the Si10xx Motherboard may be powered from the following power sources:

- 9 VDC power using the ac to dc power adapter (P2)
- 5 VDC USB VBUS power from PC via the USB Debug Adapter (J9)
- 5 VDC USB VBUS power from PC via the CP2103 USB connector (P3)

All the three power sources are ORed together using reverse-biased diodes (D1, D2, D3), eliminating the need for headers to choose between the sources. The target board will operate as long as any one of the power sources is present. The ORed power is regulated to a 3.3 V dc voltage using a LDO regulator (U2). The output of the regulator powers the +3 VD net on the target board.

If SW4 is configured to select two-cell mode, the VBAT supply net on the target board is powered directly from the +3 VD net. If SW4 is configured to select one-cell mode, the VBAT supply net is powered directly from the +1 VD. This power supply net takes +3 VD and passes it through a 1.65 V LDO. The LDO's output voltage is variable and can be set by changing the value of resistor R32.

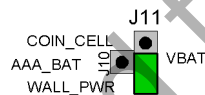

### 10.2.2. AAA Battery

When the J10/J11 three-way header is set to AAA\_BAT, the Si10xx Target Board may be powered from a single AAA battery inserted in BT1 or from the series combination of the AAA batteries inserted in BT1 and BT2. A single battery is selected when SW4 is configured to one-cell mode. The two AAA batteries configured in series to provide a voltage of ~3 V are selected when SW4 is configured to two-cell mode.

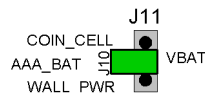

### 10.2.3. Coin Cell Battery

When the J10/J11 three-way header is set to COIN\_CELL, the Si10xx Target Board may be powered from a single 1.5 V Alkaline (A76) or Silver Oxide (357) button cell inserted in BT4 or from a single 3 V Lithium (CR2032) coin cell inserted in BT3. The button cell (BT4) is selected when SW4 is configured to one-cell mode, and the coin cell (BT3) is selected when SW4 is configured to two-cell mode.

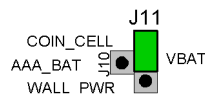

### 10.2.4. Measuring Current

The header (J17) and terminal block (H2) provide a way to measure the total supply current flowing from the power supply source to the MCU. The measured current does not include any current from the VBAT LED (DS2), the address latch (U4) or the quiescent current from the power supply; however, it does include the current used by any LEDs powered from the VDD/DC+ supply net or sourced through a GPIO pin. See the target board schematic in Figure 11 through Figure 13 for additional information.

## 10.3. System Clock Sources

### 10.3.1. Internal Oscillators

The Si10xx or Si1010 device installed on the daughtercard features a factory calibrated programmable high-frequency internal oscillator (24.5 MHz base frequency,  $\pm 2\%$ ) and a low power internal oscillator (20 MHz  $\pm 10\%$ ). After each reset, the low power oscillator divided by 8 results in a default system clock frequency of 2.5 MHz ( $\pm 10\%$ ). The selected system clock and the system clock divider may be configured by software for operation at other frequencies. For low-frequency operation, the Si10xx and Si1010 features a smaRTClock real time clock. A 32.768 kHz watch crystal (Y2) is included on the daughtercard. If you wish to operate the Si10xx device at a frequency not available with the internal oscillators, an external crystal may be used. Refer to the Si100x or Si101x data sheet for more information on configuring the system clock source.

### 10.3.2. External Oscillator Options

The daughtercards are designed to facilitate the installation of an external crystal (Y1). Install a 10 M $\Omega$  resistor at R9 and install capacitors at C20 and C21 using values appropriate for the crystal you select. If you wish to operate the external oscillator in capacitor or RC mode, options to install a capacitor or an RC network are also available on the target board. Populate C21 for capacitor mode, and populate R16 and C21 for RC mode. Refer to the Si100x-Si101x data sheet for more information on the use of external oscillators.

## 10.4. Port I/O Headers (J2, J3, J4, J6)

Access to all Port I/O on the Si10xx is provided through the headers J2, J3, and J4. The header J6 provides access to the ground plane for easy clipping of oscilloscope probes.

## 10.5. Switches and LEDs

Three push-button switches are provided on the target board. Switch SW1 is connected to the reset pin of the MCU. Pressing SW1 puts the device into its hardware-reset state. Switches SW2 and SW3 are connected to the MCU's general purpose I/O (GPIO) pins through headers. Pressing SW2 or SW3 generates a logic low signal on the port pin. Remove the shorting block from the header (J8) to disconnect the switches from the port pins. The port pin signal is also routed to pins on the J2 and P1 I/O connectors. See Table 1 for the port pins and headers corresponding to each switch.

Two touch sensitive (contactless) switches are provided on the target board. The operation of these switches require appropriate firmware running on the Si10xx MCU that can sense the state of the switch.

Five power LEDs are provided on the target board to serve as indicators. Each of the two regulators has a red LED used to indicate the presence of power at the output of the regulator. A red USB Power LED turns on when a USB cable is plugged into the USB connector P3. One power LED is also added to each of the two primary supply nets powering the MCU (VDD/DC+ and VBAT). The LEDs connected to the supply nets may be disabled by removing the shorting blocks from J1 and J5.

Two LEDs are connected to GPIO pins P1.5 and P1.6 for use by application software. See Table 1 for the port pins and headers corresponding to each LED.

A potentiometer (R15) is also provided on the target board for generating analog signals. Place a shorting block on J16 to connect the wiper to P0.6/CNVSTR. The header J15 allows the negative terminal of the potentiometer to be tied to GND or to P2.7. When tied to GND, the potentiometer is always enabled and will draw a measurable amount of supply current. When tied to P2.7, it only draws current when P2.7 is driving a logic 0 and draws no current when P2.7 is driving a logic 1.

**Table 1. Target Board I/O Descriptions**

Description	I/O	Header(s)
SW1	Reset	none
SW2	P0.2	J8[5–6]
SW3	P0.3	J8[7–8]
P0.6 (Touch Sense Switch)	P0.6	none
Red LED (P1.5)	P1.5	J8[1–2]
Yellow LED (P1.6)	P1.6	J8[3–4]
Red LED (VDD/DC+)	VDD/DC+ Supply Net	J5
Red LED (VBAT)	VBAT Supply Net	J1
Red LED (USB Power)	USB VBUS	none
Red LED (+1 VD Power)	+1 VD Regulator Output	none
Red LED (+3 VD Power)	+3 VD Regulator Output	none
Potentiometer (R15)	P0.6/P2.7	J15, J16

## 10.6. Expansion I/O Connector (P1)

The 96-pin Expansion I/O connector P1 provides access to all signal pins of the Si10xx device (except the C2 debug interface signals). In addition, power supply and ground pins are included. A small through-hole prototyping area is also provided. See Table 2 for a list of pin descriptions for P1.

**Table 2. P1 Pin Descriptions**

Row A Pin #	Description	Row B Pin #	Description	Row C Pin #	Description
1	+3 VD	1	GND	1	nc
2	nc	2	nc	2	nc
3	nc	3	nc	3	nc
4	nc	4	nc	4	nc
5	nc	5	nc	5	nc
6	nc	6	nc	6	nc
7	nc	7	nc	7	nc
8	nc	8	nc	8	nc
9	GPIO_2	9	GPIO_1	9	GPIO_0
10	nc	10	P0.1/AGND	10	P0.6/CNVSTR
11	P0.5/RX	11	P0.4/TX	11	P0.3H
12	P0.2H	12	P0.7/IREF0	12	P0.0/VREF
13	P2.1	13	nc	13	nc
14	CLK	14	NSS/PWR	14	MOSI
15	MISO/SCL	15	SCK/SDA	15	nc
16	nc	16	nc	16	nc
17	nc	17	nc	17	nc
18	nc	18	nc	18	nc
19	nc	19	nc	19	nc
20	nc	20	nc	20	nc
21	nc	21	nc	21	nc
22	nc	22	nc	22	nc
23	nc	23	nc	23	nc
24	nc	24	nc	24	nc
25	nc	25	GND	25	nc
26	GND	26	nc	26	nc
27	nc	27	nc	27	nc
28	nc	28	VDD/DC+	28	VBAT
29	nc	29	nc	29	nc
30	nc	30	nc	30	nc
31	nc	31	nc	31	nc
32	nc	32	GND	32	nc

## 10.7. Target Board DEBUG Interface (J9)

The DEBUG connector J9 provides access to the DEBUG (C2) pins of the Si10xx. It is used to connect the Serial Adapter or the USB Debug Adapter to the target board for in-circuit debugging and Flash programming. Table 3 shows the DEBUG pin definitions.

**Table 3. DEBUG Connector Pin Descriptions**

Pin #	Description
1	+3 VD (+3.3 VDC)
2, 3, 9	GND (Ground)
4	P2.7/C2D
5	$\overline{\text{RST}}$ (Reset)
6	P2.7
7	$\overline{\text{RST}}/\text{C2CK}$
8	Not Connected
10	USB Power (+5 VDC from J9)

## 10.8. Serial Interface (J12)

A USB-to-UART bridge circuit (U3) and USB connector (P3) are provided on the target board to facilitate serial connections to UART0 of the Si10xx. The Silicon Labs CP2103 (U3) USB-to-UART bridge provides data connectivity between the Si10xx and the PC via a USB port. The VIO power supply and TX, RX, RTS and CTS signals of UART0 may be connected to the CP2103 by installing shorting blocks on header J12. The shorting block positions for connecting each of these signals to the CP2103 are listed in Table 4. To use this interface, the USB-to-UART device drivers should be installed as described in Section 3.2. "CP210x USB to UART VCP Driver Installation," on page 2.

**Table 4. Serial Interface Header (J12) Description**

Header Pins	UART0 Pin Description
J12[9–10]	CP2103_VIO (VDD/DC+)
J12[7–8]	TX_MCU (P0.5)
J12[5–6]	RX_MCU (P0.4)
J12[3–4]	RTS (P0.6)
J12[1–2]	CTS (P0.7)

## 10.9. Analog I/O (H1)

Several of the Si10xx target device's port pins are connected to the H1 terminal block. Refer to Table 5 for the H1 terminal block connections.

**Table 5. H1 Terminal Block Pin Descriptions**

Pin #	Description
1	P0.6/CNVSTR
2	P0.7/IREF0
3	GND (Ground)
4	P0.0/ $V_{\text{REF}}$ (Voltage Reference)

# Si10xx-DK

---

## 10.10. IREF Connector (J7)

The Si1000 Motherboard also features a current-to-voltage 1 k $\Omega$  load resistor that may be connected to the current reference (IREF0) output that can be enabled on port pin (P0.7). Install a shorting block on J7 to connect port pin P0.7 of the target device to the load resistor. If enabled by software, the IREF0 signal is then routed to the J2[8] and H1[2] connectors.

## 10.11. VREF and AGND Connector (J13, J14)

The Si1000 Motherboard also features 4.7  $\mu$ F capacitor in parallel with a 0.1  $\mu$ F that can be connected to P0.0/VREF when using the Precision Voltage Reference. The capacitors are connected to P0.0/VREF when a shorting block is installed on J13. Using the Precision Voltage Reference is optional since Si10xx devices have an on-chip High-Speed Voltage Reference.

The shorting block J14 allows P0.1/AGND to be connected to ground. This provides a noise-free ground reference to the analog-to-digital Converter. The use of this dedicated analog ground is optional.

## 10.12. C2 Pin Sharing

On the Si10xx, the debug pins C2CK and C2D are shared with the pins  $\overline{\text{RST}}$  and P2.7, respectively. The target board includes the resistors necessary to enable pin sharing which allow the  $\overline{\text{RST}}$  and P2.7 pins to be used normally while simultaneously debugging the device. See Application Note “AN124: Pin Sharing Techniques for the C2 Interface” at [www.silabs.com](http://www.silabs.com) for more information regarding pin sharing.

11. Schematics

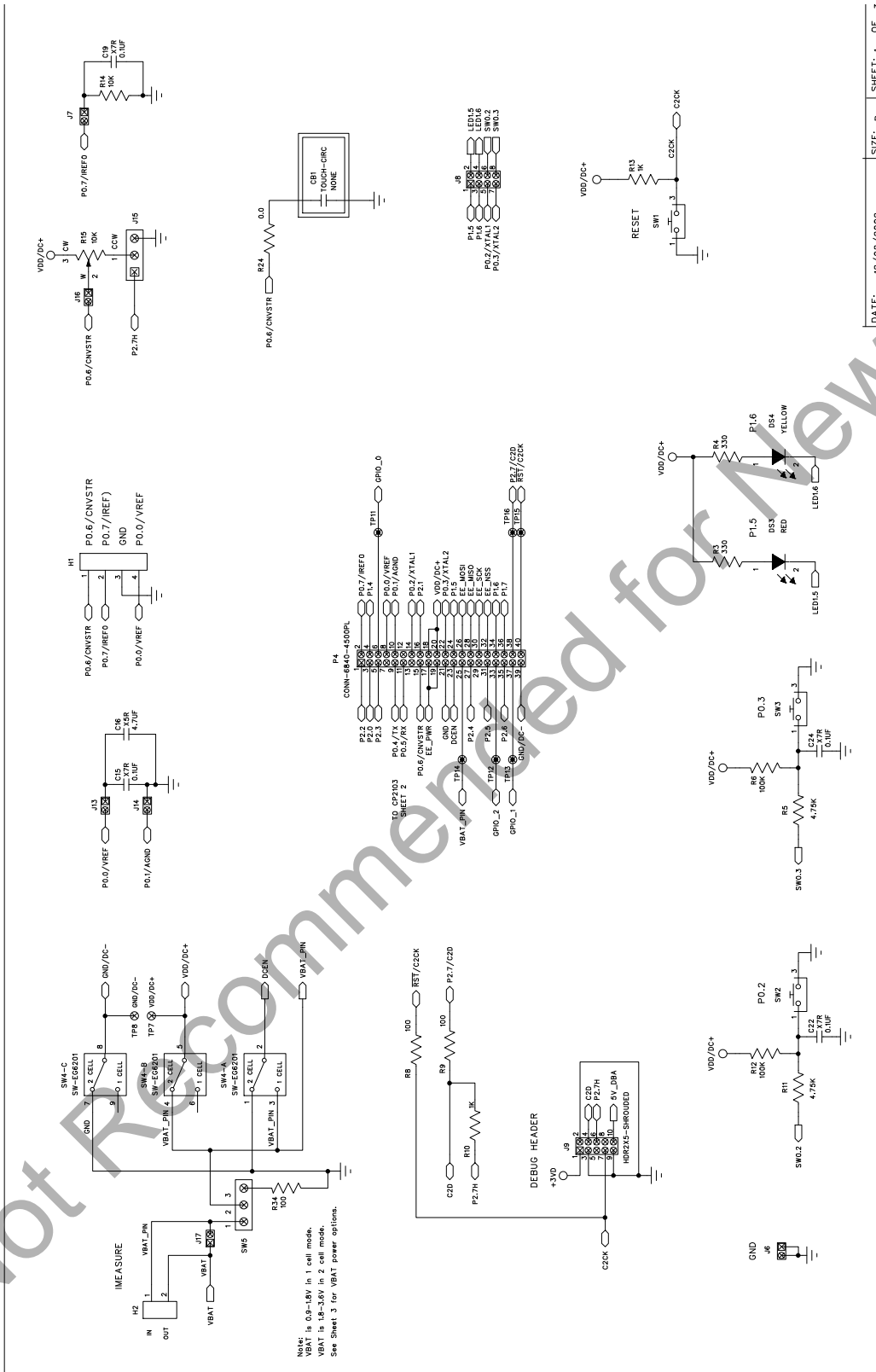

Figure 11. Si1000 Motherboard Schematic (1 of 3)

DATE: 12/02/2009 SIZE: B SHEET: 1 OF 3

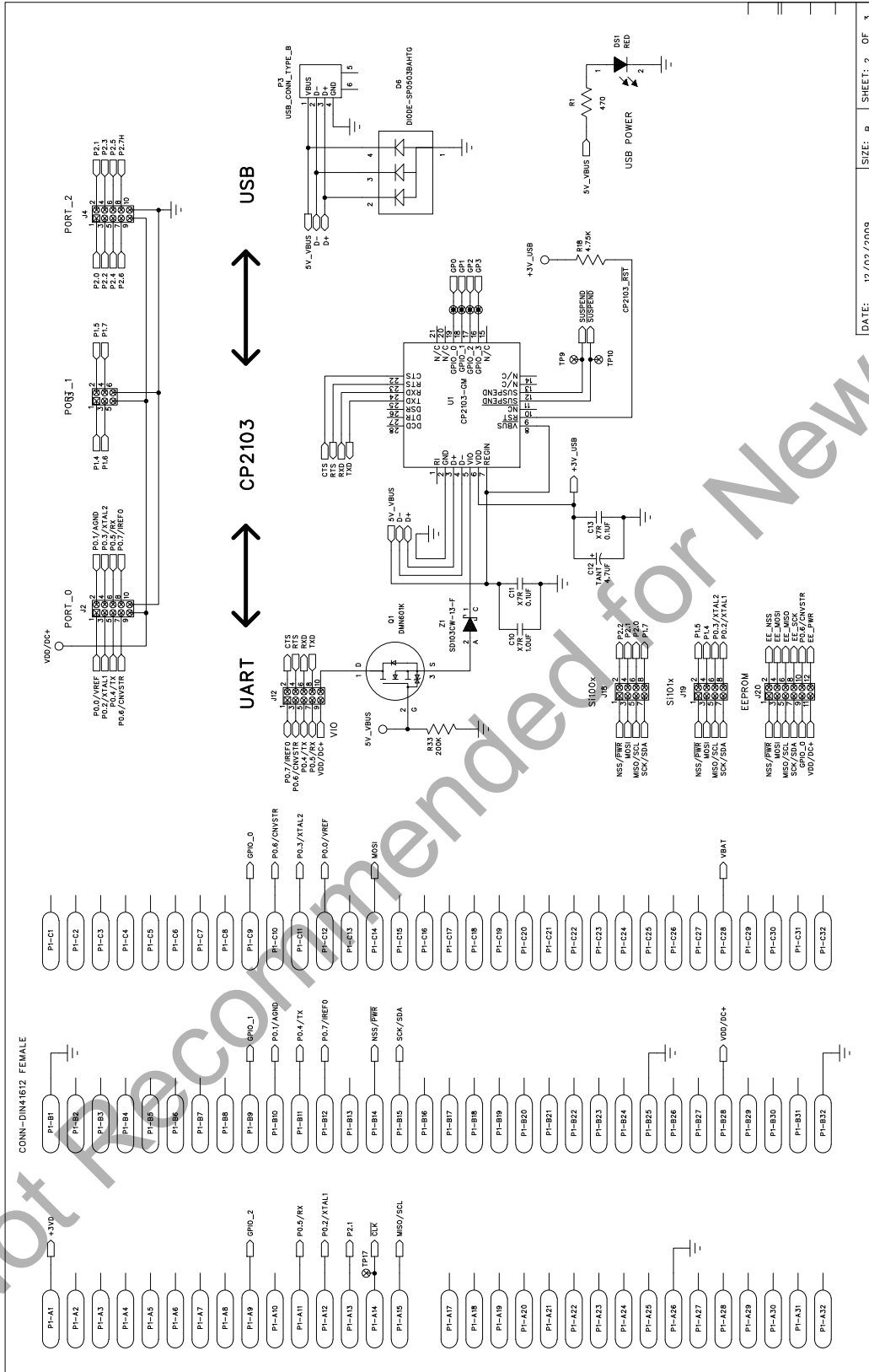

Figure 12. Si10000 Motherboard Schematic (2 of 3)

DATE: 12/02/2009

SIZE: B

SHEET: 2

OF 3

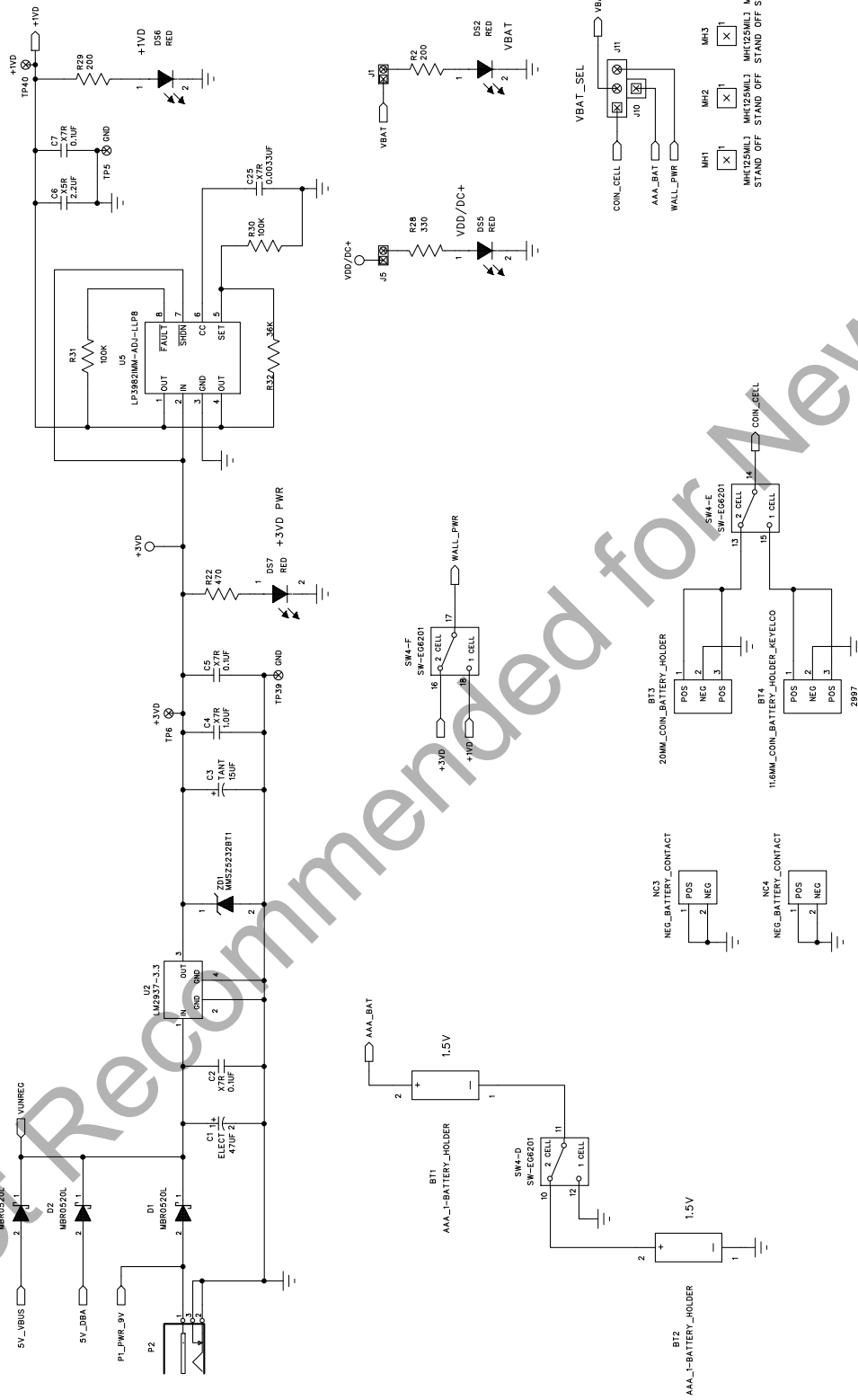

Figure 13. Si1000 Motherboard Schematic (3 of 3)

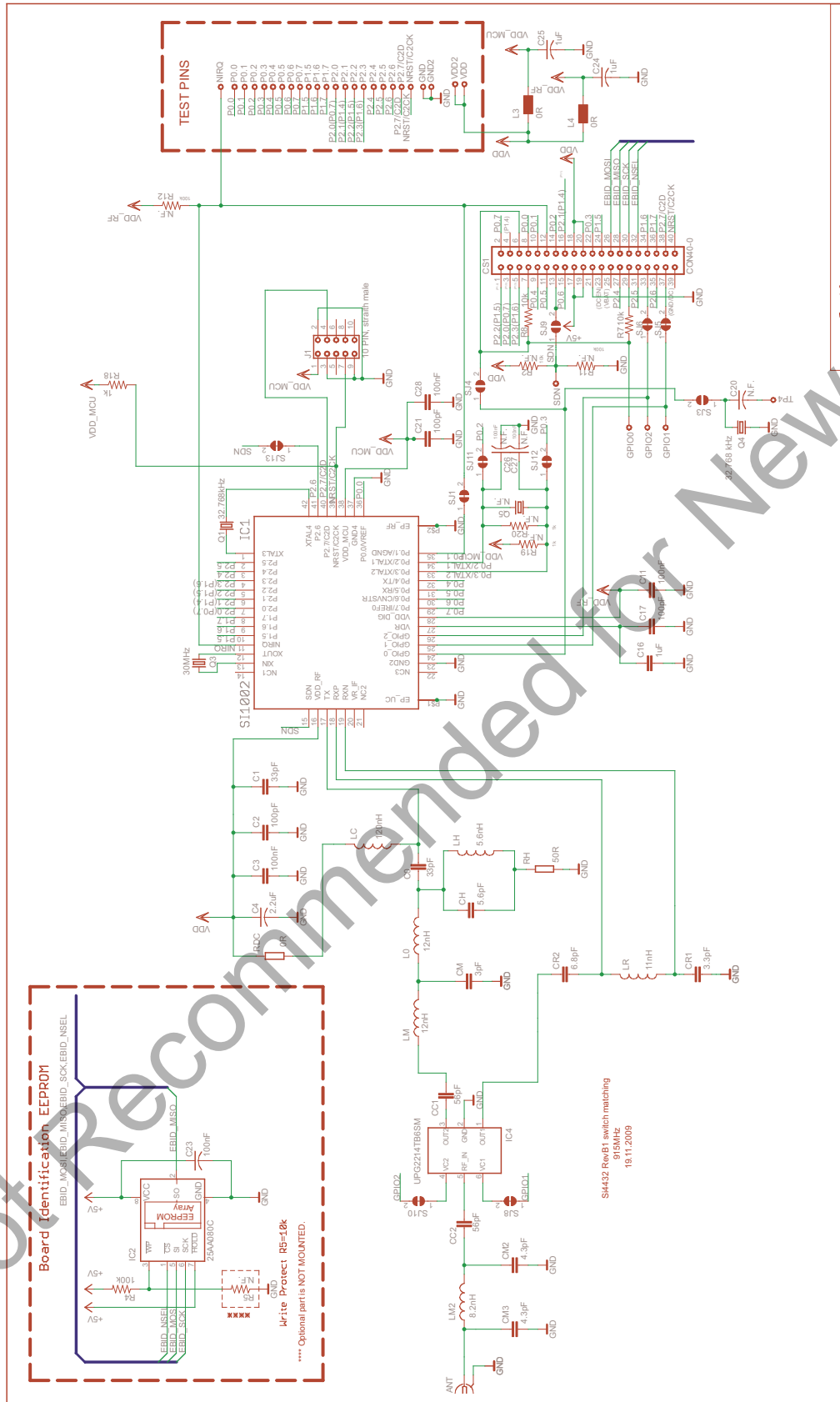
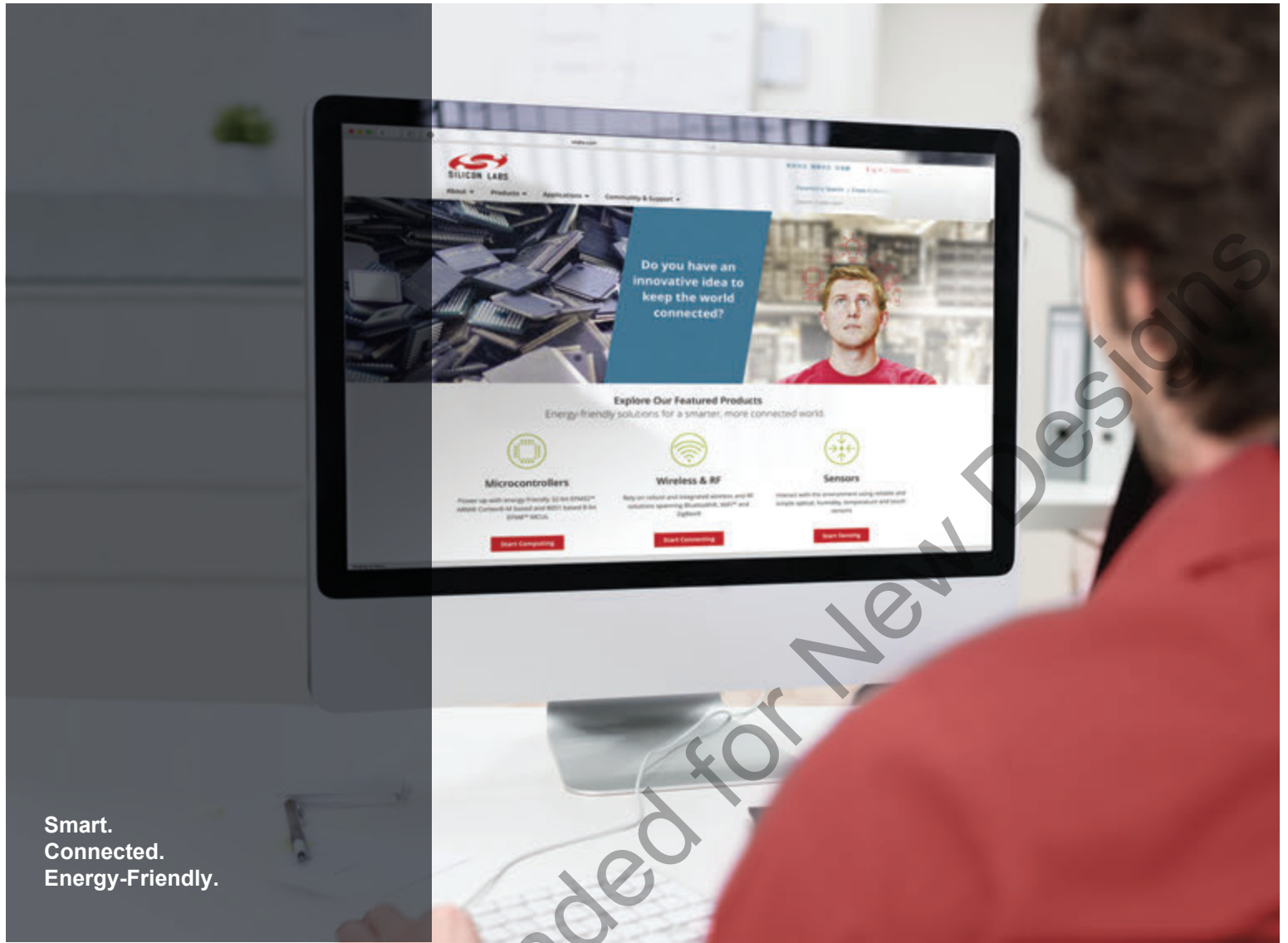

Figure 14. Si10000 Daughtercard Schematic

**NOTES:**

*Not Recommended for New Designs*



Smart.  
Connected.  
Energy-Friendly.



**Products**  
[www.silabs.com/products](http://www.silabs.com/products)

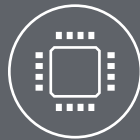

**Quality**  
[www.silabs.com/quality](http://www.silabs.com/quality)



**Support and Community**  
[community.silabs.com](http://community.silabs.com)

**Disclaimer**

Silicon Laboratories intends to provide customers with the latest, accurate, and in-depth documentation of all peripherals and modules available for system and software implementers using or intending to use the Silicon Laboratories products. Characterization data, available modules and peripherals, memory sizes and memory addresses refer to each specific device, and "Typical" parameters provided can and do vary in different applications. Application examples described herein are for illustrative purposes only. Silicon Laboratories reserves the right to make changes without further notice and limitation to product information, specifications, and descriptions herein, and does not give warranties as to the accuracy or completeness of the included information. Silicon Laboratories shall have no liability for the consequences of use of the information supplied herein. This document does not imply or express copyright licenses granted hereunder to design or fabricate any integrated circuits. The products are not designed or authorized to be used within any Life Support System without the specific written consent of Silicon Laboratories. A "Life Support System" is any product or system intended to support or sustain life and/or health, which, if it fails, can be reasonably expected to result in significant personal injury or death. Silicon Laboratories products are not designed or authorized for military applications. Silicon Laboratories products shall under no circumstances be used in weapons of mass destruction including (but not limited to) nuclear, biological or chemical weapons, or missiles capable of delivering such weapons.

**Trademark Information**

Silicon Laboratories Inc.®, Silicon Laboratories®, Silicon Labs®, SiLabs® and the Silicon Labs logo®, Bluegiga®, Bluegiga Logo®, Clockbuilder®, CMEMS®, DSPLL®, EFM®, EFM32®, EFR®, Ember®, Energy Micro, Energy Micro logo and combinations thereof, "the world's most energy friendly microcontrollers", Ember®, EZLink®, EZRadio®, EZRadioPRO®, Gecko®, ISOModem®, Precision32®, ProSLIC®, Simplicity Studio®, SiPHY®, Telegesis, the Telegesis Logo®, USBXpress® and others are trademarks or registered trademarks of Silicon Laboratories Inc. ARM, CORTEX, Cortex-M3 and THUMB are trademarks or registered trademarks of ARM Holdings. Keil is a registered trademark of ARM Limited. All other products or brand names mentioned herein are trademarks of their respective holders.



Silicon Laboratories Inc.  
400 West Cesar Chavez  
Austin, TX 78701  
USA

<http://www.silabs.com>

## Looking for pricing, stock, or lifecycle information?

Click below to explore more details on WIN SOURCE:

 [View S11010DK](#) on WIN SOURCE

 [Silicon Labs](#) Information

## Optimize Your Supply Chain with WIN SOURCE Solutions

-  Global Sourcing Solution
-  Obsolete Management
-  Cost Control Management
-  Shortage Management
-  Alternative Solution
-  Excess Inventory Management