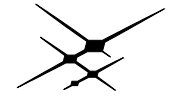




**THE DATASHEET OF  
SKY65047-360EK2**





# SKY65047-360LF: 0.4-3.0 GHz Low-Noise Amplifier

## Applications

- Wireless infrastructure: WLAN, WiMAX, broadband, cellular base stations
- Test instrumentation
- Satellite receivers
- Paging
- Remote metering
- WLL and ISM receivers
- GPS receivers

## Features


- Noise Figure = 1.2 dB @ 915 MHz
- Noise Figure = 0.8 dB @ 1575 MHz
- Noise Figure = 1.1 dB @ 2450 MHz
- Small signal gain = 16.6 dB @ 1575 MHz
- Low operating current = 7.2 mA
- External, adjustable bias setting
- Built-in power-down control
- Single DC supply voltage, 2.7 V to 3.8 V
- Miniature DFN (8-pin, 2 x 2 mm) package (MSL1, 260 °C per JEDEC J-STD-020)

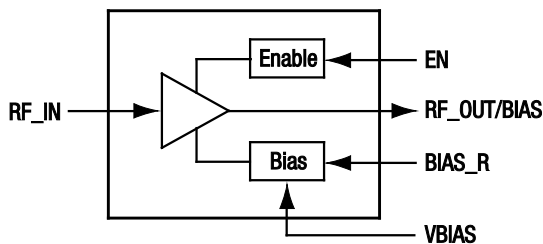
## Description

The SKY65047-360LF is a high linearity Low-Noise Amplifier (LNA). The excellent gain, superior low-noise and low current consumption makes the SKY65047-360LF ideal for use in wireless infrastructure applications. The device may also be used in a variety of LNA applications. All active circuitry in the module is contained in a single Microwave Monolithic Integrated Circuit (MMIC).

The device is manufactured with an advanced silicon germanium (SiGe) process, which allows a single supply operation while maintaining excellent low-noise performance and linearity. The SKY65047-360LF is provided in a low-cost, miniature 2 x 2 mm Dual Flat No-Lead (DFN) package.

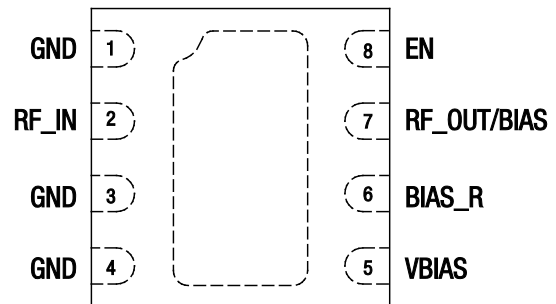
A functional block diagram is shown in Figure 1. The pin configuration and package are shown in Figure 2. Signal pin assignments and functional pin descriptions are provided in Table 1.

 Skyworks Pb-free products are compliant with all applicable legislation. For additional information, refer to *Skyworks Definition of Lead (Pb)-Free*, document number SQ04-0073.



S1487

Figure 1. SKY65047-360LF Block Diagram



S1486

Figure 2. SKY65047-360LF Pinout – 8-Pin DFN (Top View)

**Table 1. SKY65047-360LF Signal Descriptions**

Pin #	Name	Description	Pin #	Name	Description
1	GND	Ground	5	VBIAS	VCC bias voltage
2	RF_IN	RF input	6	BIAS_R	Bias reference voltage
3	GND	Ground	7	RF_OUT/BIAS	RF output/VCC bias
4	GND	Ground	8	EN	Amplifier enable control

**Functional Description**

The SKY65047-360LF is a single stage, low noise amplifier in a low-cost surface mount package. The device operates with a single +3.3 V power supply connected through an RF choke to the output pin. Surface mount capacitors provide DC bias decoupling for VCC.

The bias current is set by a reference voltage transistor and by resistor R1. Pin 2 (RF\_IN) is the RF input and Pin 7 (RF-OUT/BIAS) is the RF output. The part is externally RF matched and DC blocked using surface mount components to facilitate operation over a frequency range of 0.4 to 3.0 GHz. Pins 1, 3, and 4, and the package backside metal provide the DC and RF ground.

The SKY65047-360LF includes an internal PA enable (pin 8, EN) for fast RF on/off control. A logic low voltage level disables the PA; a logic high voltage level enables the PA.

**Electrical and Mechanical Specifications**

The absolute maximum ratings of the SKY65047-360LF are provided in Table 2. The recommended operating conditions are specified in Table 3 and electrical specifications are provided in Table 4.

Typical performance characteristics for the SKY65047-360LF are illustrated in Figures 3 through 8.

**Table 2. SKY65047-360LF Absolute Maximum Ratings**

Parameter	Symbol	Minimum	Typical	Maximum	Units
Supply voltage	V <sub>CC</sub>			4	V
Total supply current	I <sub>BIAS</sub>			20	mA
RF input power	P <sub>IN</sub>			+20	dBm
Storage temperature	T <sub>STG</sub>	-65		+125	°C
Junction temperature	T <sub>J</sub>			+125	°C
Case temperature	T <sub>CASE</sub>	-40		+85	°C

**Note:** Exposure to maximum rating conditions for extended periods may reduce device reliability. There is no damage to device with only one parameter set at the limit and all other parameters set at or below their nominal value.

**CAUTION:** Although this device is designed to be as robust as possible, Electrostatic Discharge (ESD) can damage this device. This device must be protected at all times from ESD. Static charges may easily produce potentials of several kilovolts on the human body or equipment, which can discharge without detection. Industry-standard ESD precautions should be used at all times.

**Table 3. SKY65047-360LF Recommended Operating Conditions**

Parameter	Symbol	Minimum	Typical	Maximum	Units
Frequency	f	0.4		3.0	GHz
RF input power	P <sub>IN</sub>			-20	dBm
Bias supply voltage (Note 1)	V <sub>BIAS</sub>	2.7	3.3	3.8	V
Amplifier enable control (on)	EN <sub>ON</sub>	V <sub>CC</sub> -0.3		V <sub>CC</sub>	V
Amplifier enable control (off)	EN <sub>OFF</sub>	0		0.2	V
Operating temperature	T <sub>OP</sub>	-40	+25	+85	°C

**Note 1:** Voltage applied to pin 5 (VBIAS) and pin 7 (RF\_OUT/BIAS).

**Table 4. SKY65047-360LF Electrical Specifications (Note 1) (1 of 2)**  
**(VBIAS and EN = 3.3 V, Characteristic Impedance [Z<sub>0</sub>] = 50 Ω, T<sub>CASE</sub> = 25 °C, Unless Otherwise Noted)**

Parameter	Symbol	Test Condition	Min	Typical	Max	Units
<b>450 MHz Matched Performance</b>						
Gain	G			19.6		dB
Gain variation over temperature	G	25 °C to -40 °C or 25 °C to +85 °C		±0.5		dB
Isolation	Iso			-32.7		dB
Noise Figure	NF			1.4		dB
Noise Figure variation over temperature	NF	25 °C to -40 °C or 25 °C to +85 °C		±0.3		dB
3 <sup>rd</sup> Order Input Intercept Point	IIP3			-6		dBm
3 <sup>rd</sup> Order Input Intercept Point variation over temperature	IIP3	25 °C to -40 °C or 25 °C to +85 °C		±0.7		dB
Input return loss	IRL	With external matching		14		dB
Output return loss	ORL	With external matching		15		dB
Supply current	I <sub>cc</sub>	Bias resistor = 4.7 kΩ		6.9		mA
<b>915 MHz Matched Performance</b>						
Gain	G			17		dB
Gain variation over temperature	G	25 °C to -40 °C or 25 °C to +85 °C		±0.4		dB
Isolation	Iso			28		dB
Noise Figure	NF			1.2		dB
Noise Figure variation over temperature	NF	25 °C to -40 °C or 25 °C to +85 °C		±0.2		dB
1 dB Input Compression Point	IP1 dB			-16.5		dBm
3 <sup>rd</sup> Order Input Intercept Point	IIP3	P <sub>M</sub> = -30 dBm/tone, 200 kHz spacing		+0.8		dBm
3 <sup>rd</sup> Order Input Intercept Point variation over temperature	IIP3	25 °C to -40 °C or 25 °C to +85 °C		±0.5		dB
Input return loss	IRL	With external matching		15.5		dB
Output return loss	ORL	With external matching		12.7		dB
Supply current	I <sub>cc</sub>	Bias resistor = 4.7 kΩ		6.5		mA
<b>1575 MHz Matched Performance</b>						
Gain	G			16.6		dB
Gain variation over temperature	G	25 °C to -40 °C or 25 °C to +85 °C		±0.6		dB
Isolation	Iso		22	26		dB
Noise Figure	NF			0.8	1.2	dB
Noise Figure variation over temperature	NF	25 °C to -40 °C or 25 °C to +85 °C		±0.3		dB
1 dB Input Compression Point	IP1 dB		-18.4	-15.8		dBm
3 <sup>rd</sup> Order Input Intercept Point	IIP3	P <sub>M</sub> = -30 dBm/tone, 200 kHz spacing	+1.0	+3.2		dBm
3 <sup>rd</sup> Order Input Intercept Point variation over temperature	IIP3	25 °C to -40 °C or 25 °C to +85 °C		±0.8		dB

**Table 4. SKY65047-360LF Electrical Specifications (Note 1) (2 of 2)**  
**(VBIAS and EN = 3.3 V, Characteristic Impedance [Z<sub>0</sub>] = 50 Ω, T<sub>CASE</sub> = 25 °C, Unless Otherwise Noted)**

Parameter	Symbol	Test Condition	Min	Typical	Max	Units
<b>1575 MHz Matched Performance (continued)</b>						
Input return loss	IRL	With external matching	10.0	14.5		dB
Output return loss	ORL	With external matching	10	12		dB
Supply current	I <sub>cc</sub>	Bias resistor = 4.7 kΩ		7.2		mA
<b>1900 MHz Matched Performance</b>						
Gain	G			15.9		dB
Gain variation over temperature	G	25 °C to -40 °C or 25 °C to +85 °C		±0.3		dB
Isolation	I <sub>so</sub>			22		dB
Noise Figure	NF			1.3		dB
Noise Figure variation over temperature	NF	25 °C to -40 °C or 25 °C to +85 °C		±0.2		dB
1 dB Input Compression Point	IP1dB			-12.8		dBm
3 <sup>rd</sup> Order Input Intercept Point	IIP3			+4.7		dBm
3 <sup>rd</sup> Order Input Intercept Point variation over temperature	IIP3	25 °C to -40 °C or 25 °C to +85 °C		±0.4		dB
Input return loss	IRL	With external matching		18		dB
Output return loss	ORL	With external matching		23		dB
Supply current	I <sub>cc</sub>	Bias resistor = 4.7 kΩ		7.1		mA
<b>2450 MHz Matched Performance</b>						
Gain	G			14.8		dB
Gain variation over temperature	G	25 °C to -40 °C or 25 °C to +85 °C		±0.3		dB
Isolation	I <sub>so</sub>			21		dB
Noise Figure	NF			1.1		dB
Noise Figure variation over temperature	NF	25 °C to -40 °C or 25 °C to +85 °C		±0.2		dB
1 dB Input Compression Point	IP1dB			-9.6		dBm
3 <sup>rd</sup> Order Input Intercept Point	IIP3	P <sub>IN</sub> = -30 dBm/tone, 200 kHz spacing		+7.5		dBm
3 <sup>rd</sup> Order Input Intercept Point variation over temperature	IIP3	25 °C to -40 °C or 25 °C to +85 °C		±0.3		dB
Input return loss	IRL	With external matching		14		dB
Output return loss	ORL	With external matching		16		dB
Supply current	I <sub>cc</sub>	Bias resistor = 4.7 kΩ		6.4		mA
<b>Power-Down</b>						
Leakage current	I <sub>LKG</sub>	No RF		0.1		μA

**Note 1:** Performance is guaranteed only under the conditions listed in this Table.

### Typical Performance Characteristics

(VBIAS and EN = 3.3 V, Characteristic Impedance [Z<sub>0</sub>] = 50 Ω, T<sub>CASE</sub> = 25 °C, Unless Otherwise Noted)

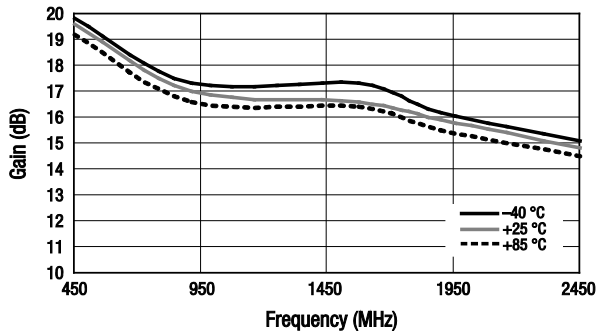


Figure 3. Gain Over Temperature and Frequency

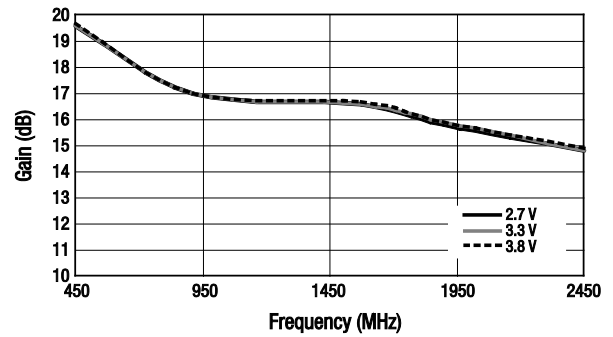


Figure 4. Gain Over Supply Voltage and Frequency

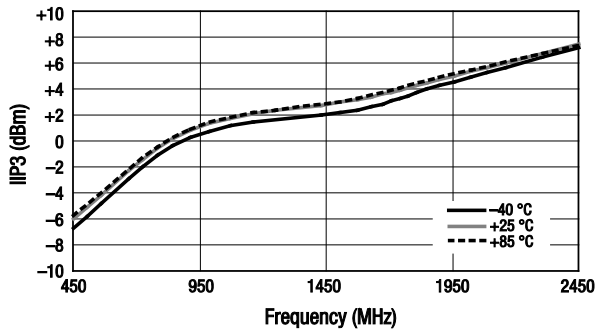


Figure 5. IIP3 Over Temperature and Frequency

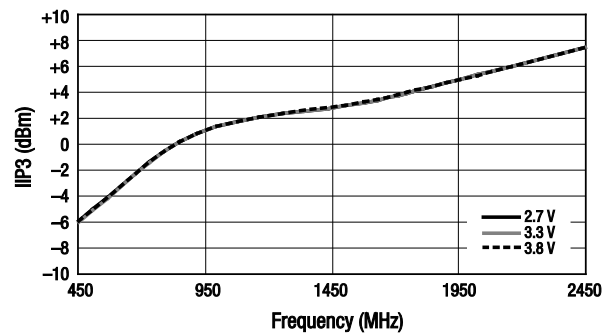


Figure 6. IIP3 Over Supply Voltage and Frequency

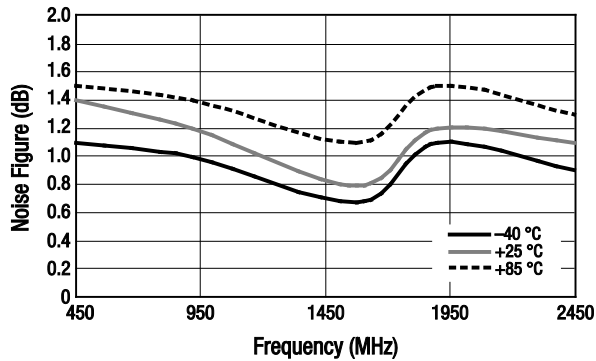


Figure 7. Noise Figure Over Temperature and Frequency

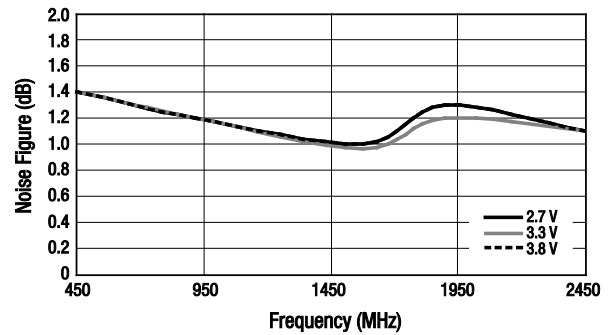


Figure 8. Noise Figure Over Supply Voltage and Frequency

## Evaluation Board Description

The SKY65047-360LF Evaluation Board is used to test the performance of the SKY65047-360LF LNA. Three different boards are available, depending on the desired performance frequency: 915 MHz, 1575 MHz, and 2450 MHz.

Evaluation Board schematic diagrams are provided in Figures 9, 11, and 13. Assembly drawings for the Evaluation Board are shown in Figures 10, 12, and 14.

Evaluation Board layer detail drawings for the 915 MHz, 1575 MHz, and 2450 MHz boards are shown in Figures 15, 16, and 17, respectively. Layer detail physical characteristics are noted in Figure 18.

## Circuit Design Considerations

The following design considerations are general in nature and must be followed regardless of final use or configuration:

1. Paths to ground should be made as short as possible.
2. The ground pad of the SKY65047-360LF has special electrical and thermal grounding requirements. This pad is the main thermal conduit for heat dissipation. Since the circuit board acts as the heat sink, it must shunt as much heat as possible from the device. Therefore, design the connection to the ground pad to dissipate the maximum wattage produced by the circuit board. Multiple vias to the grounding layer are required.

**NOTE:** A poor connection between the slug and ground increases junction temperature ( $T_j$ ), which reduces the lifetime of the device.

## Evaluation Board Test Procedure

- Step 1: Connect RF test equipment to amplifier input/output SMA connectors.
- Step 2: Connect DC ground.
- Step 3: Connect VCC to a +3.3 V supply. Verify that the board draws approximately 6.7 mA.
- Step 4: Connect pin 8 (EN) to a +3.3 V supply to enable the LNA. Set EN to 0 V to disable the LNA.
- Step 5: Apply an RF input signal of -40 dBm and observe the output signal level. This level should be approximately -23.5 dBm with a gain equal to approximately 16.5 dB.

## Application Circuit Notes

**Center Ground.** It is extremely important to sufficiently ground the bottom ground pad of the device for both thermal and stability

reasons. Multiple small vias are acceptable and will work well under the device if solder migration is an issue.

**GND (pins 1, 3, and 4).** Attach all ground pins to the RF ground plane with the largest diameter and lowest inductance via that the layout allows. Multiple small vias are acceptable and will work well under the device if solder migration is an issue. Pin 3 can also be connected to ground with a small inductance of emitter degeneration.

**RF\_IN (pin 2).** The LNA requires a DC blocking capacitor as part of the external RF matching.

**VBIAS (pin 5).** The bias supply voltage for the LNA is typically set to +3.3 V using a bias resistor.

**BIAS\_R (pin 6).** This pin is typically connected to ground through a bias resistor.

**RF\_OUT/BIAS (pin 7).** The LNA collector supply voltage is supplied through an RF choke (component L3 on the 915 MHz and 2450 MHz Evaluation Boards, and component L2 on the 1575 MHz Evaluation Board) to the output at pin 7. The LNA requires a DC blocking capacitor as part of the external RF matching.

**EN (pin 8).** A logic low voltage level disables the internal PA; a logic high voltage level enables the internal PA.

## Package Dimensions

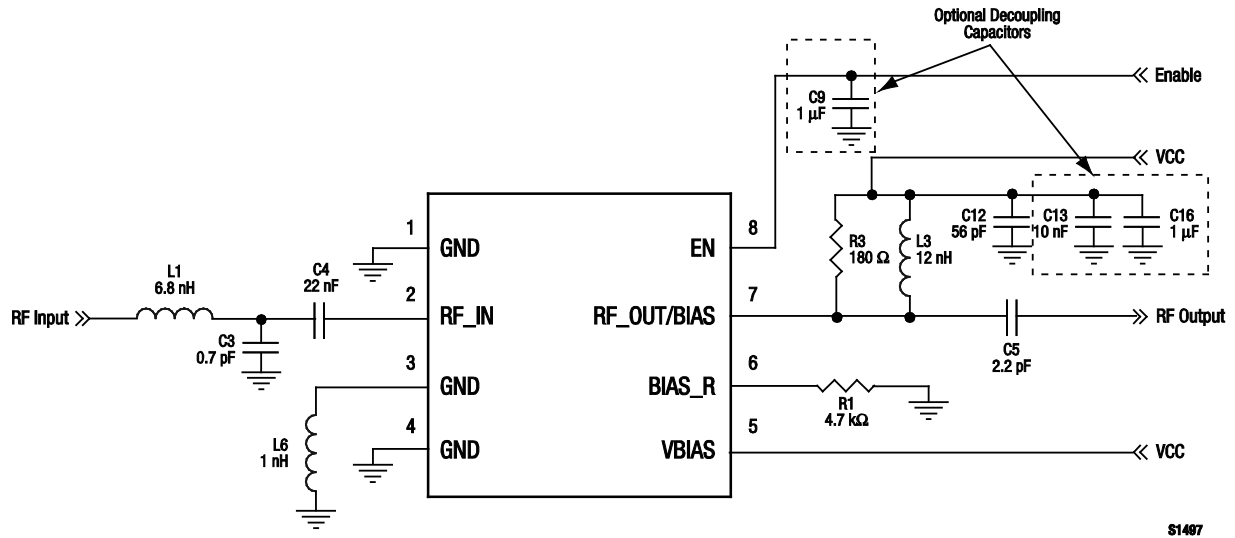
The PCB layout footprint for the SKY65047-360LF is shown in Figure 19. Typical case markings are shown in Figure 20. Package dimensions for the 8-pin DFN are shown in Figure 21, and tape and reel dimensions are provided in Figure 22.

## Package and Handling Information

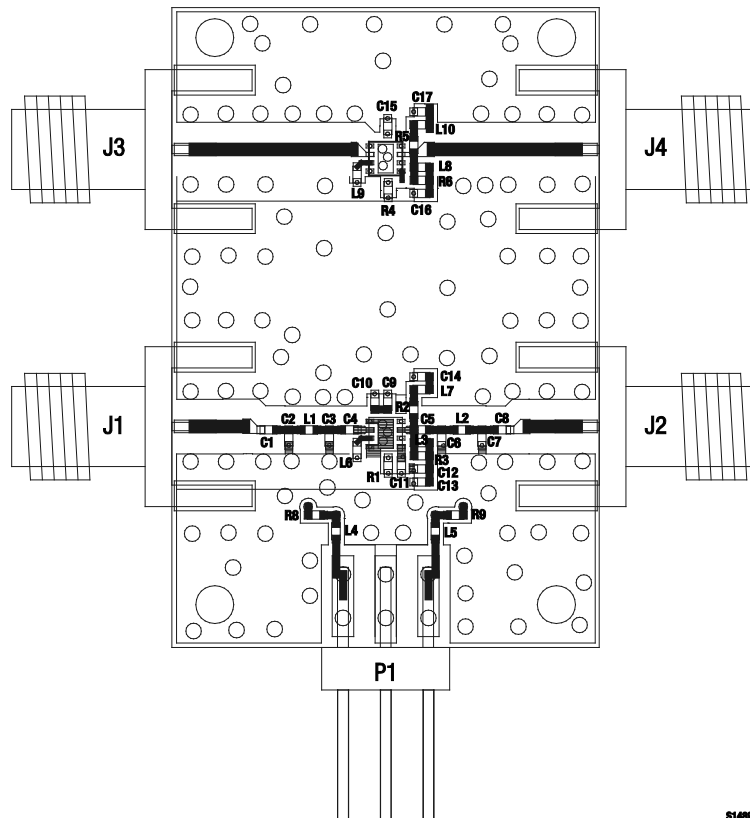
Since the device package is sensitive to moisture absorption, it is baked and vacuum packed before shipping. Instructions on the shipping container label regarding exposure to moisture after the container seal is broken must be followed. Otherwise, problems related to moisture absorption may occur when the part is subjected to high temperature during solder assembly.

THE SKY65047-360LF is rated to Moisture Sensitivity Level 1 (MSL1) at 260 °C. It can be used for lead or lead-free soldering. For additional information, refer to the Skyworks Application Note, *Solder Reflow Information*, document number 200164.

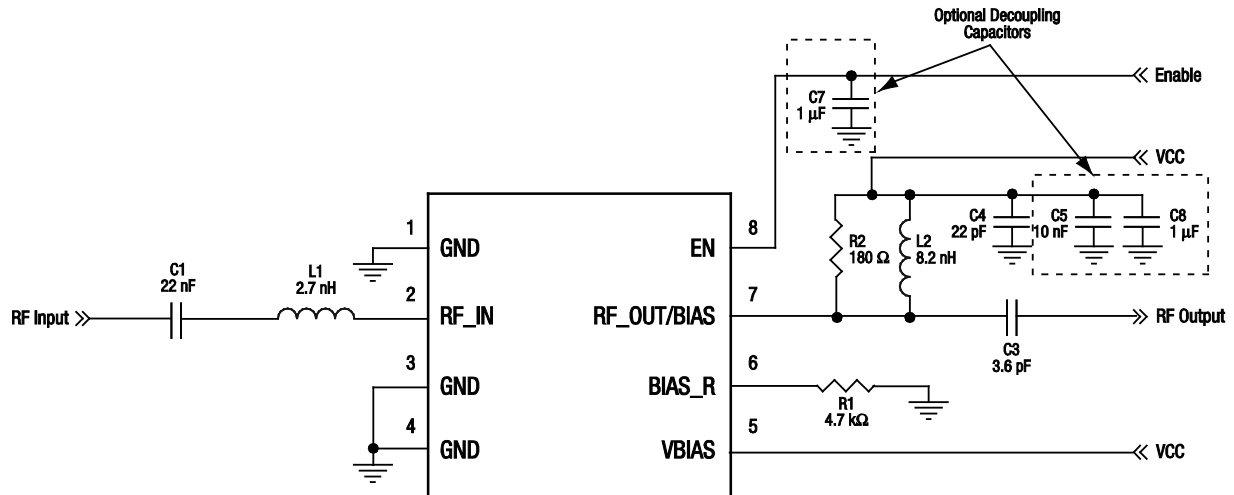
Care must be taken when attaching this product, whether it is done manually or in a production solder reflow environment. Production quantities of this product are shipped in a standard tape and reel format.



**Figure 9. SKY65047-360LF Evaluation Board Schematic (915 MHz)**

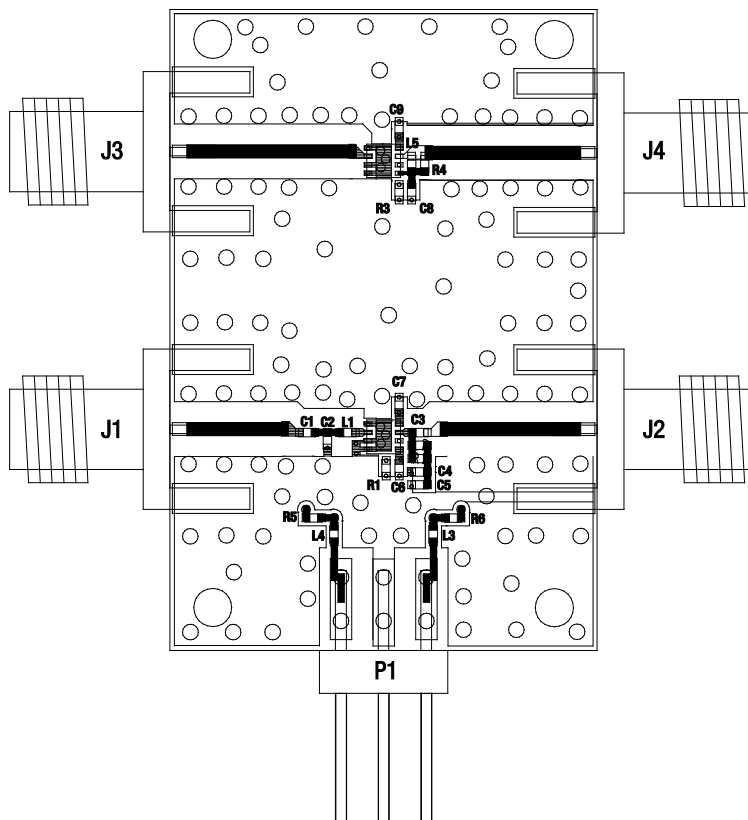


**Figure 10. SKY65047-360LF Evaluation Board Assembly Diagram (915 MHz)**



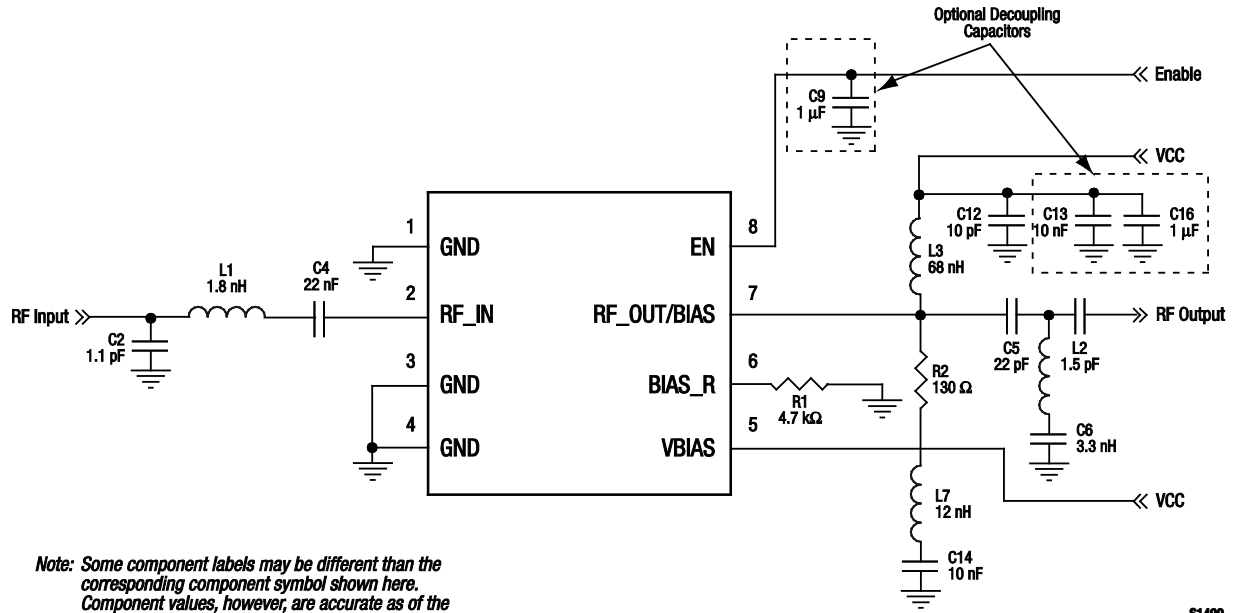
S1488

Figure 11. SKY65047-360LF Evaluation Board Schematic (1575 MHz)



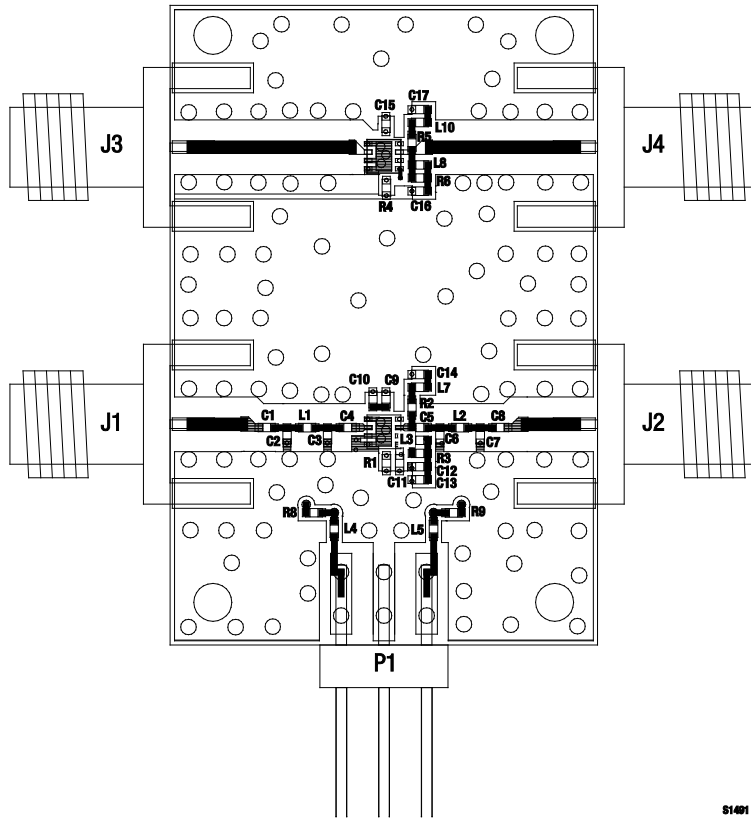
S1490

Figure 12. SKY65047-360LF Evaluation Board Assembly Diagram (1575 MHz)



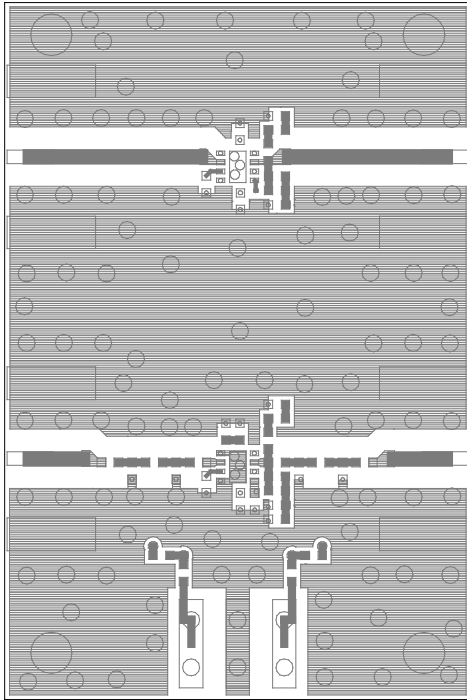
S1489

Figure 13. SKY65047-360LF Evaluation Board Schematic (2450 MHz)

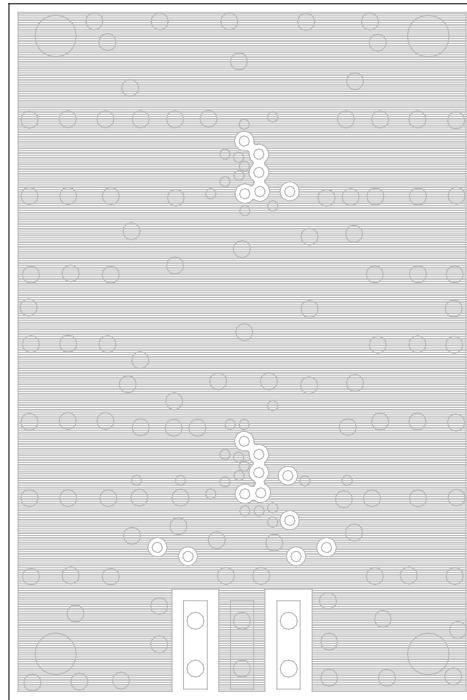


S1489

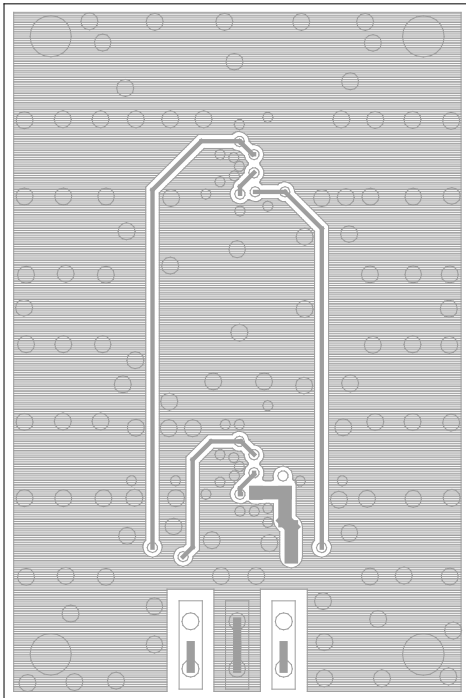
Figure 14. SKY65047-360LF Evaluation Board Assembly Diagram (2450 MHz)



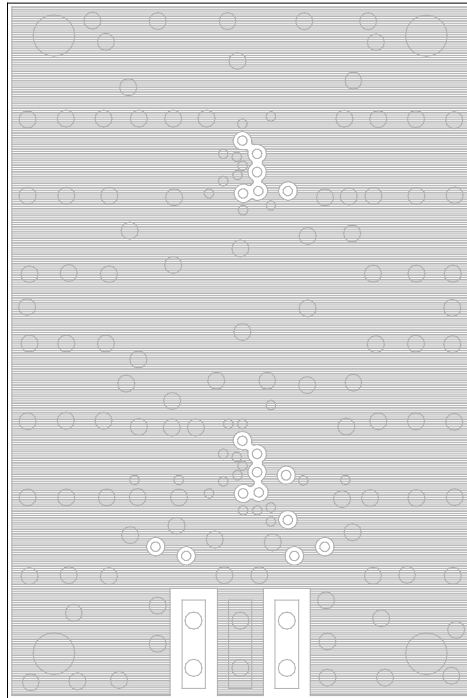
Layer 1: Top – Metal



Layer 2: Ground



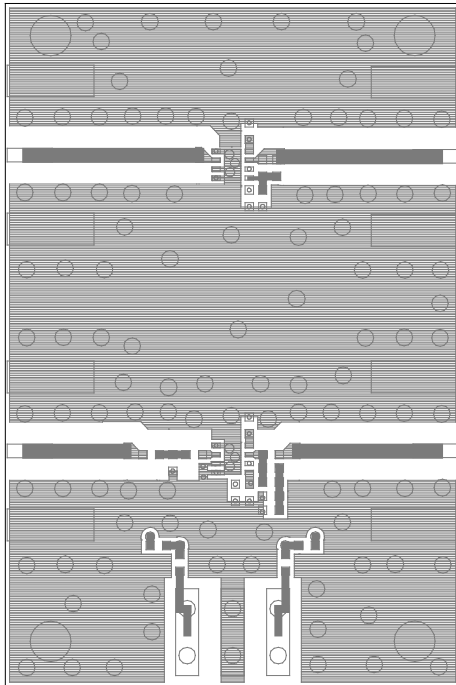
Layer 3: Power Plane



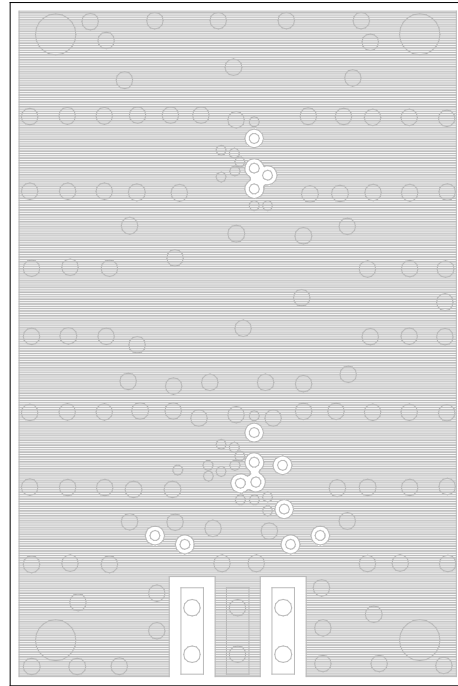
Layer 4: Solid Ground Plane

S1492

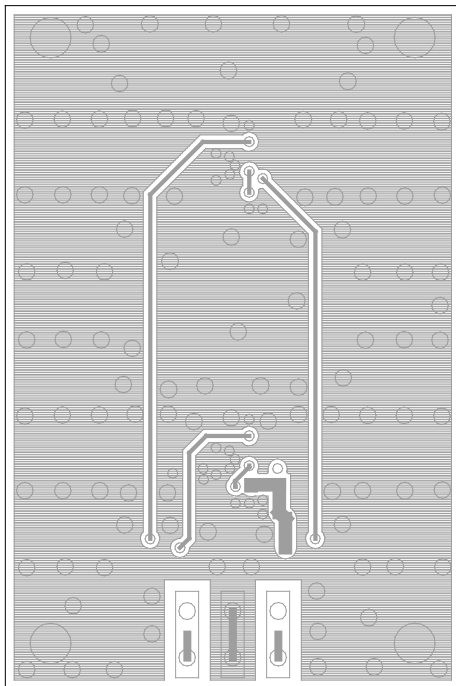
Figure 15. SKY65047-360LF Evaluation Board Layer Detail (915 MHz)



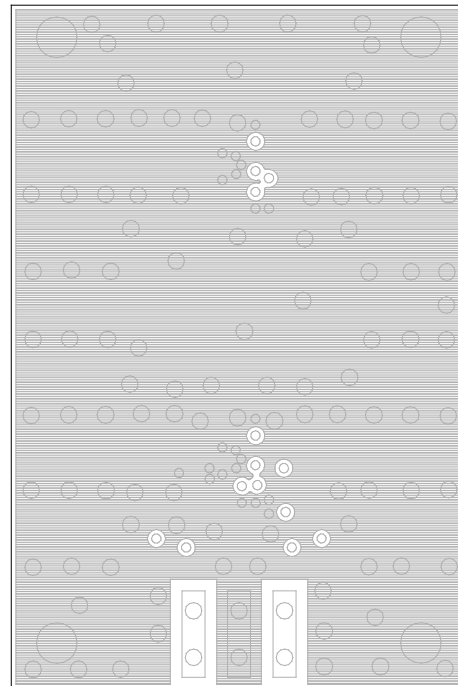
Layer 1: Top – Metal



Layer 2: Ground



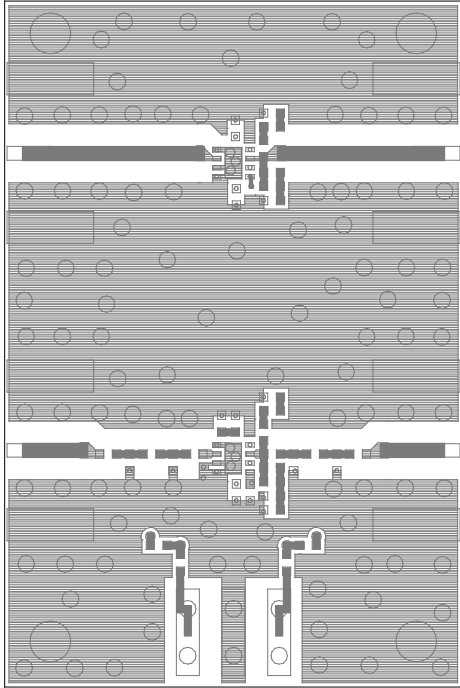
Layer 3: Power Plane



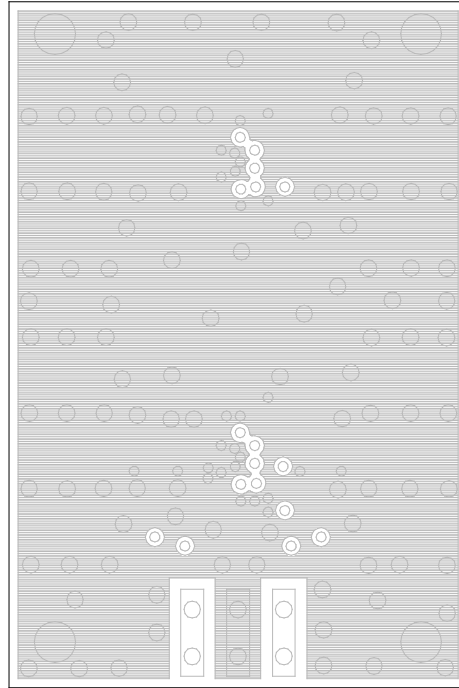
Layer 4: Solid Ground Plane

S1483

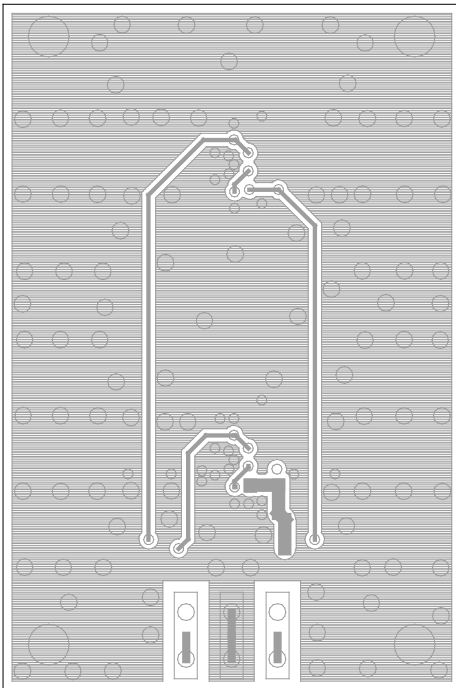
**Figure 16. SKY65047-360LF Evaluation Board Layer Detail (1575 MHz)**



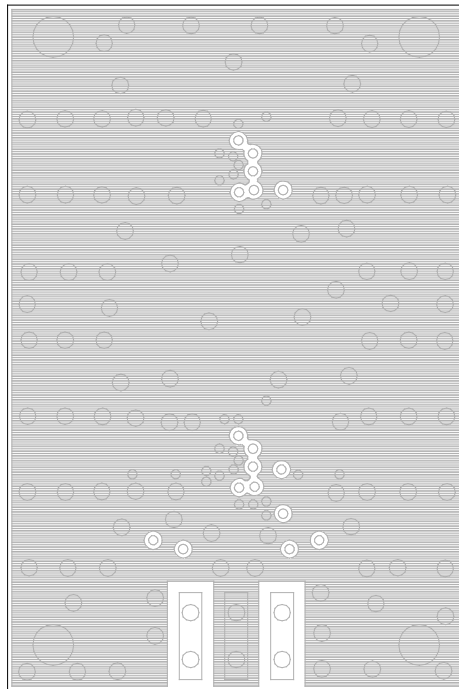
Layer 1: Top – Metal



Layer 2: Ground



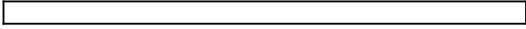
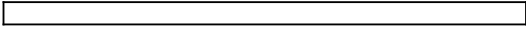
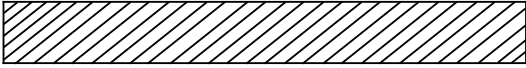
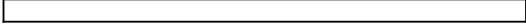

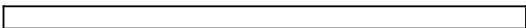
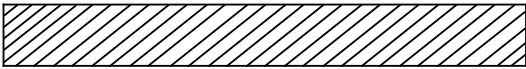


Layer 3: Power Plane



Layer 4: Solid Ground Plane

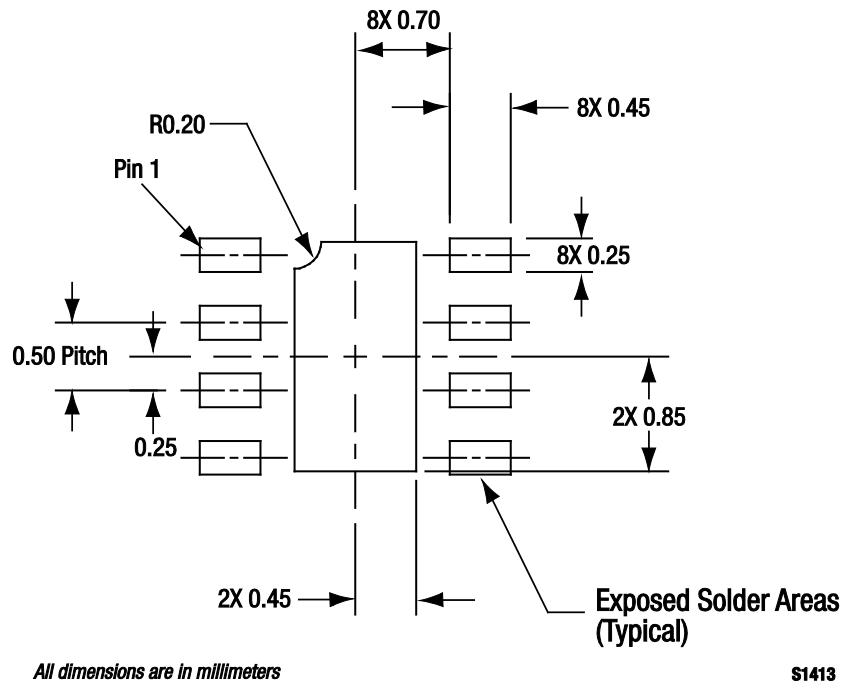
S1494

Figure 17. SKY65047-360LF Evaluation Board Layer Detail (2450 MHz)

Cross Section	Name	Thickness (mm)	Material
	Top solder mask		
	L1	0.025 min.	Cu, 1 oz.
	Laminate	0.400 ± 0.025	Rogers 4003
	L2	0.025 min.	Cu, 1 oz
	Laminate	0.400 ± 0.040	Prepreg
	L3	0.025 min.	Cu, 1 oz
	Laminate	0.400 ± 0.025	Glass reinforced core
	L4	0.025 min.	Cu, 1 oz
	Bottom solder mask		

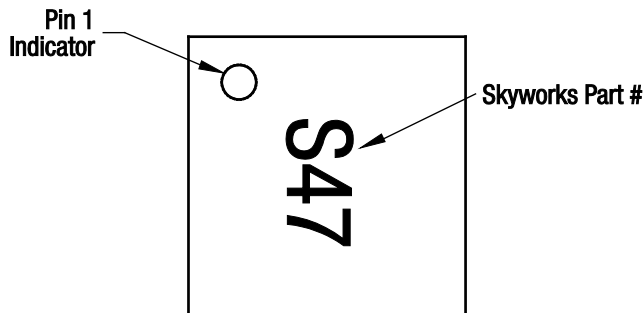
S1495

Figure 18. Layer Detail Physical Characteristics



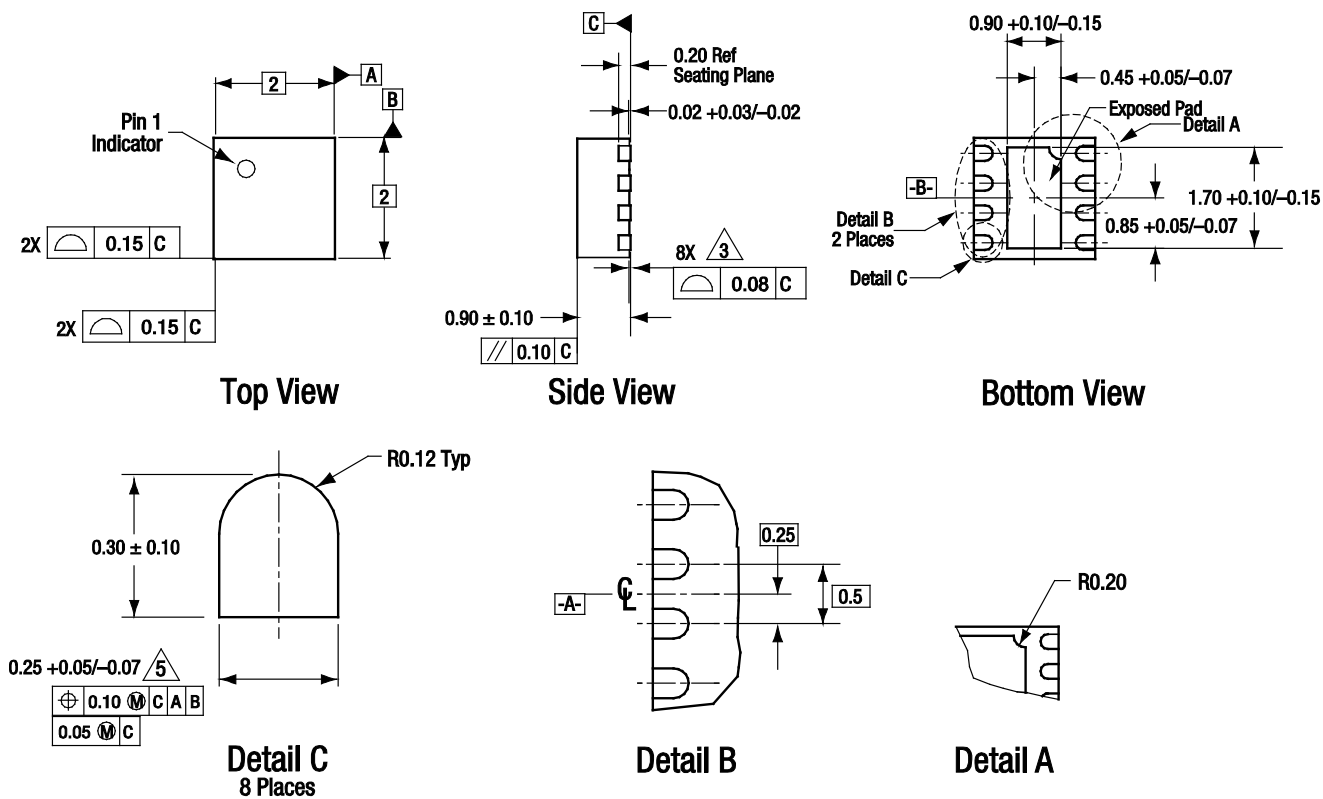
S1413

Figure 19. SKY65047-360LF PCB Layout Footprint (Top View)



S1488

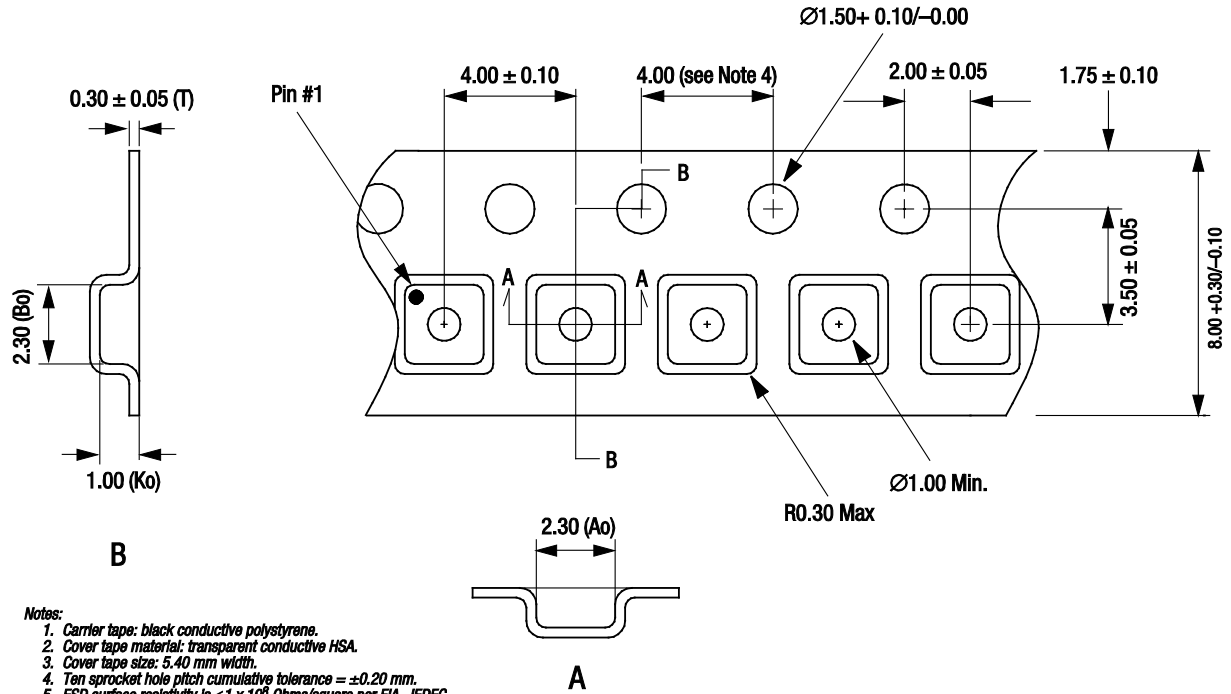
Figure 20. Typical Case Markings (Top View)



All measurements are in millimeters.  
 Dimensioning and tolerancing according to ASME Y14.5M-1994.  
 Coplanarity applies to the exposed heat sink slug as well as the terminals.  
 Plating requirement per source control drawing (SCD) 2504.  
 Dimension applies to metallized terminal and is measured between 0.15 mm and 0.30 mm from terminal tip.

S1415

Figure 21. SKY65047-360LF 8-Pin DFN Package Dimensions



- Notes:
1. Carrier tape: black conductive polystyrene.
  2. Cover tape material: transparent conductive HSA.
  3. Cover tape size: 5.40 mm width.
  4. Ten sprocket hole pitch cumulative tolerance =  $\pm 0.20$  mm.
  5. ESD surface resistivity is  $\leq 1 \times 10^9$  Ohms/square per EIA, JEDEC tape and reel specification.
  6. Ao and Bo measurement point to be 0.30 mm from bottom pocket.
  7. All measurements are in millimeters.

S1601

Figure 22. SKY65047-360LF Tape and Reel Dimensions

**Ordering Information**

Model Name	Manufacturing Part Number	Evaluation Board Part Number
SKY65047-360LF Low Noise Amplifier	SKY65047-360LF	TW17-D900 (915 MHz) TW17-D910 (1575 MHz) TW17-D920 (2450 MHz)

Copyright © 2009, 2010, 2011 Skyworks Solutions, Inc. All Rights Reserved.

Information in this document is provided in connection with Skyworks Solutions, Inc. (“Skyworks”) products or services. These materials, including the information contained herein, are provided by Skyworks as a service to its customers and may be used for informational purposes only by the customer. Skyworks assumes no responsibility for errors or omissions in these materials or the information contained herein. Skyworks may change its documentation, products, services, specifications or product descriptions at any time, without notice. Skyworks makes no commitment to update the materials or information and shall have no responsibility whatsoever for conflicts, incompatibilities, or other difficulties arising from any future changes.

No license, whether express, implied, by estoppel or otherwise, is granted to any intellectual property rights by this document. Skyworks assumes no liability for any materials, products or information provided hereunder, including the sale, distribution, reproduction or use of Skyworks products, information or materials, except as may be provided in Skyworks Terms and Conditions of Sale.

THE MATERIALS, PRODUCTS AND INFORMATION ARE PROVIDED “AS IS” WITHOUT WARRANTY OF ANY KIND, WHETHER EXPRESS, IMPLIED, STATUTORY, OR OTHERWISE, INCLUDING FITNESS FOR A PARTICULAR PURPOSE OR USE, MERCHANTABILITY, PERFORMANCE, QUALITY OR NON-INFRINGEMENT OF ANY INTELLECTUAL PROPERTY RIGHT; ALL SUCH WARRANTIES ARE HEREBY EXPRESSLY DISCLAIMED. SKYWORKS DOES NOT WARRANT THE ACCURACY OR COMPLETENESS OF THE INFORMATION, TEXT, GRAPHICS OR OTHER ITEMS CONTAINED WITHIN THESE MATERIALS. SKYWORKS SHALL NOT BE LIABLE FOR ANY DAMAGES, INCLUDING BUT NOT LIMITED TO ANY SPECIAL, INDIRECT, INCIDENTAL, STATUTORY, OR CONSEQUENTIAL DAMAGES, INCLUDING WITHOUT LIMITATION, LOST REVENUES OR LOST PROFITS THAT MAY RESULT FROM THE USE OF THE MATERIALS OR INFORMATION, WHETHER OR NOT THE RECIPIENT OF MATERIALS HAS BEEN ADVISED OF THE POSSIBILITY OF SUCH DAMAGE.



Skyworks products are not intended for use in medical, lifesaving or life-sustaining applications, or other equipment in which the failure of the Skyworks products could lead to personal injury, death, physical or environmental damage. Skyworks customers using or selling Skyworks products for use in such applications do so at their own risk and agree to fully indemnify Skyworks for any damages resulting from such improper use or sale.

Customers are responsible for their products and applications using Skyworks products, which may deviate from published specifications as a result of design defects, errors, or operation of products outside of published parameters or design specifications. Customers should include design and operating safeguards to minimize these and other risks. Skyworks assumes no liability for applications assistance, customer product design, or damage to any equipment resulting from the use of Skyworks products outside of stated published specifications or parameters.

Skyworks, the Skyworks symbol, and “Breakthrough Simplicity” are trademarks or registered trademarks of Skyworks Solutions, Inc., in the United States and other countries. Third-party brands and names are for identification purposes only, and are the property of their respective owners. Additional information, including relevant terms and conditions, posted at [www.skyworksinc.com](http://www.skyworksinc.com), are incorporated by reference.

## Looking for pricing, stock, or lifecycle information?

Click below to explore more details on WIN SOURCE:

-  [View SKY65047-360EK2 on WIN SOURCE](#)
-  [Skyworks Solutions Inc. Information](#)

## Optimize Your Supply Chain with WIN SOURCE Solutions

-  Global Sourcing Solution
-  Obsolete Management
-  Cost Control Management
-  Shortage Management
-  Alternative Solution
-  Excess Inventory Management