



**THE DATASHEET OF
SI4770-A-EVB**



Si477x EVALUATION BOARD USER'S GUIDE

Description

The Si477x EVB is a platform designed to simplify evaluation and development with the Silicon Laboratories Si477x series tuners. The platform includes both hardware and software tools to easily configure and operate the tuner.

This guide contains the following information:

- Quick Start Guide: Three quick steps to set up your board and tune a station
- Kit Contents: Components included in the kit
- Software/GUI Guide: Installation and usage of the evaluation GUI
- Hardware Guide: Description, configuration, and design files for baseboard and daughtercards

Features

- Complete antenna-to-audio evaluation system
- Intuitive software interface supports simple evaluation to detailed performance testing
- Flexible hardware interface for evaluation and prototyping of various RF front end circuit options
- Portable operation facilitates field measurements with only a PC

Functional Block Diagram

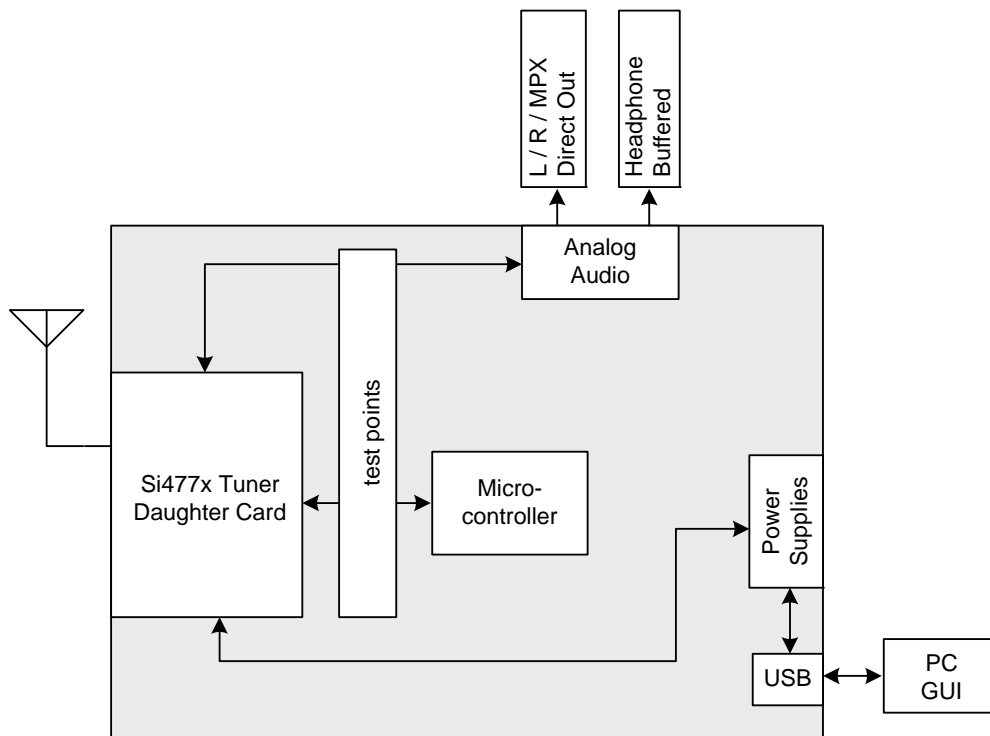

Si477x-EVB

1. Introduction

Thank you for purchasing the Silicon Laboratories Si477x Evaluation Kit. This kit includes hardware and software tools to facilitate evaluation and development with the Si477x AM/FM Tuner family.

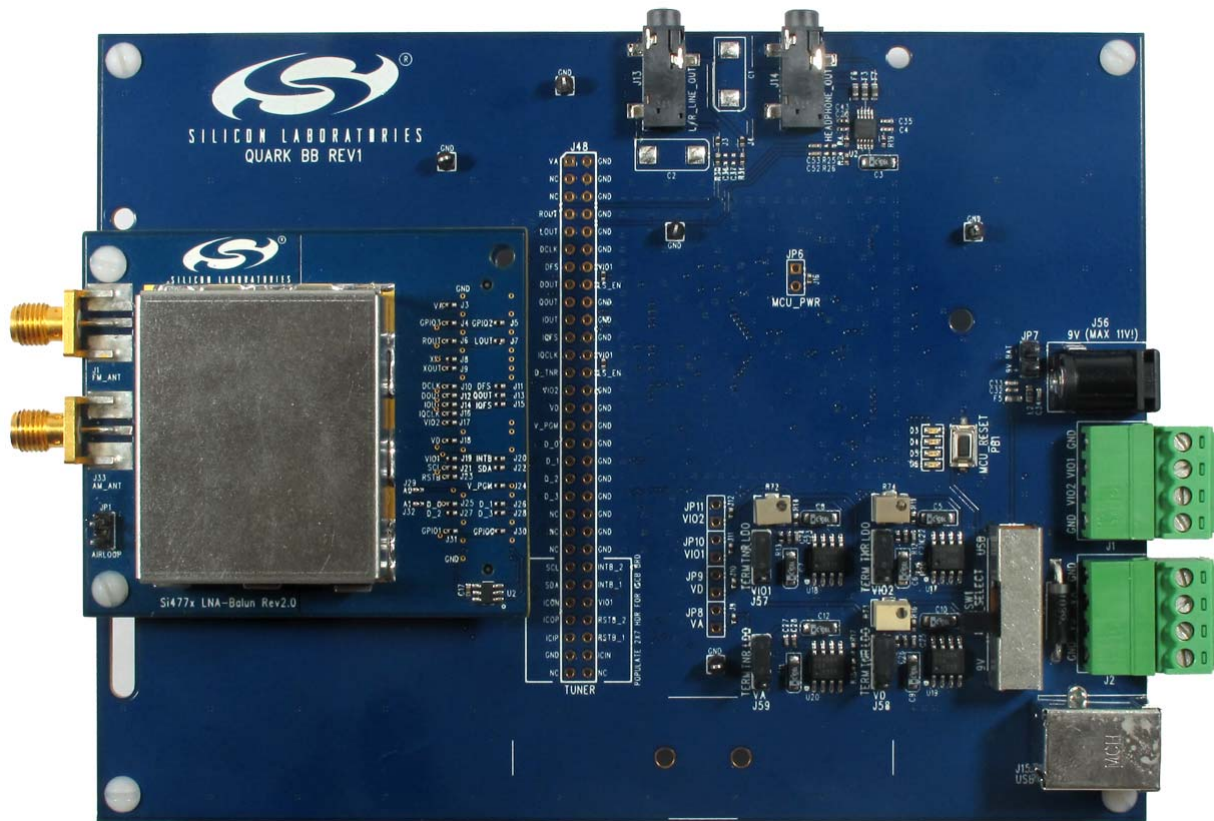

Figure 1. Si477x Evaluation Board

Register at www.silabs.com for additional application notes, articles, and other support resources.

2. Kit Contents

2.1. Si477x-EVB Evaluation Board

All material and information contained in the enclosure is confidential and covered under non-disclosure agreement (NDA).

- Quark baseboard (1)
- Si477x Rev 2.0 and later daughtercard (1)
- USB cable (1)
- BNC to RCA adapters (2)
- RCA cable (1)
- Loop antenna (1)
- BNC to SMA adapter (1)
- Headphones (1)
- 9 V universal adapter (1)
- Documentation and software CD including the following:
 - Si477x-EVB User's Guide
 - Development GUI Software and Example Code
 - Microsoft.net Framework for use with the Development GUI
 - AN645: Si477x Programming Guide
 - Si477x Release Notes

2.2. Si4770Module-A-EVB Module Kit

Separately from the Si477x-EVB kit, user's may also order an Si4770Module-A-EVB kit. All material and information contained in the enclosure is confidential and covered under non-disclosure agreement (NDA).

- 4-Layer Si4770 Module Rev1.0
- Si477x Interposer Rev1.0 card

Si477x-EVB

3. Quick-Start Guide

This section gives three quick steps to get your evaluation kit installed and running. Refer to the following sections for additional details on configuring and using the kit.

3.1. Install the Software

- Insert the CD.
- Open the file **Start_Here.htm**.
- Click on the link to the GUI.
- Run **setup.exe**.

3.2. Connect the Board

- Configure the PCB for USB as the power source:
 - Slide switch to "USB".
 - Place four jumpers between "LDO" and "TNR" positions.

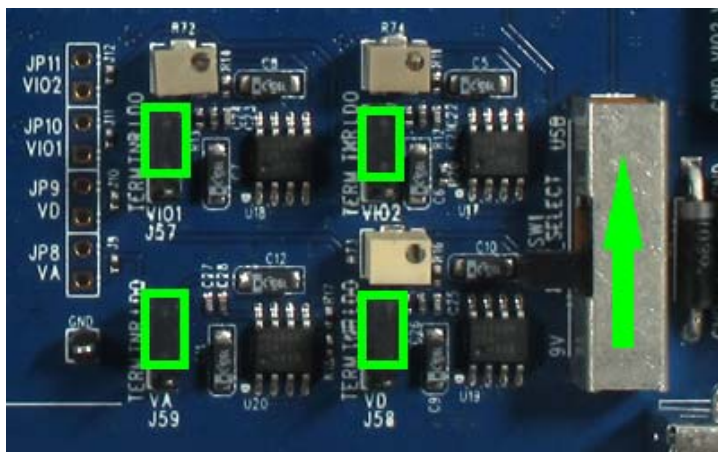

Figure 2. Selecting USB Power Source

- Connect headphones or powered speakers to the HEADPHONE_OUT jack.

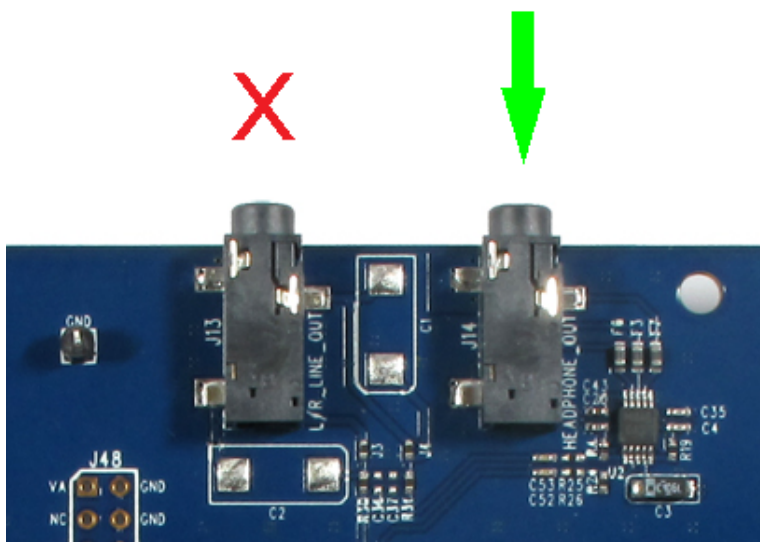

Figure 3. Audio Output Connection

- Connect an AM loop antenna or FM whip antenna to the tuner daughtercard using the appropriate connection. For conducted tests, a signal source may be connected to AM or FM using the appropriate SMA connectors.

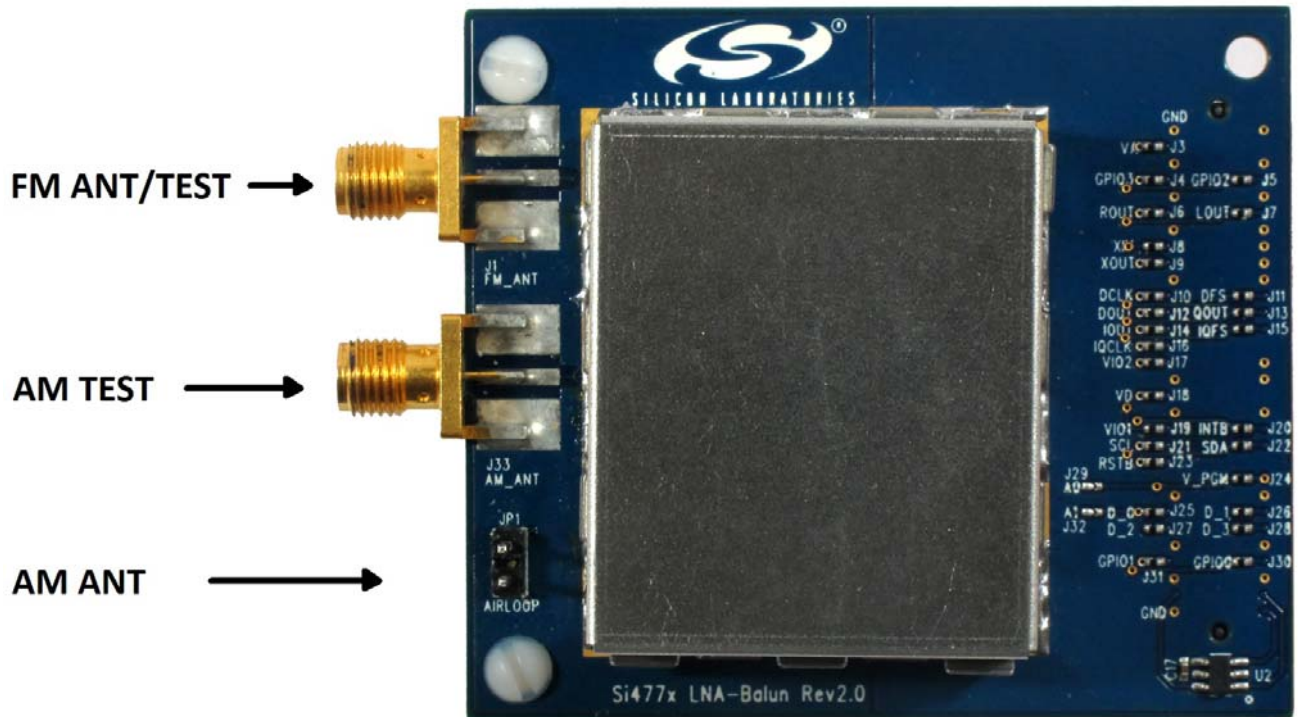

Figure 4. Antenna Connections

Si477x-EVB

3.3. Listen

- Launch the GUI from the desktop shortcut:



- Select FM receive mode, click *Initialize*:

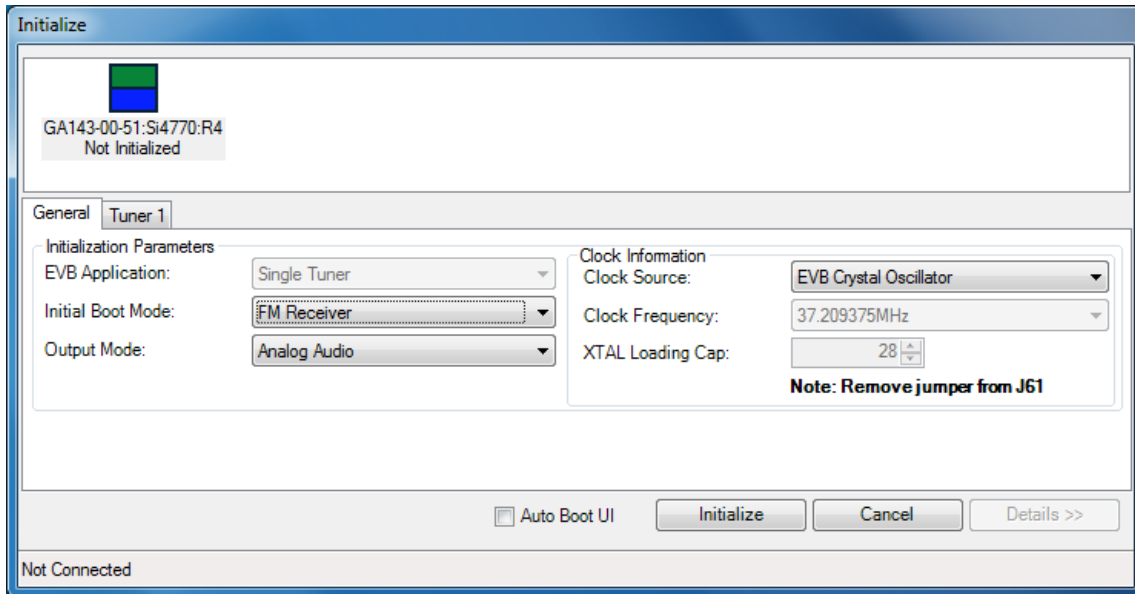

Figure 5. Initialization Window

- Tune a station by entering the frequency or dragging the tuning slider.
- Decrease the volume by dragging the *Volume* slider.

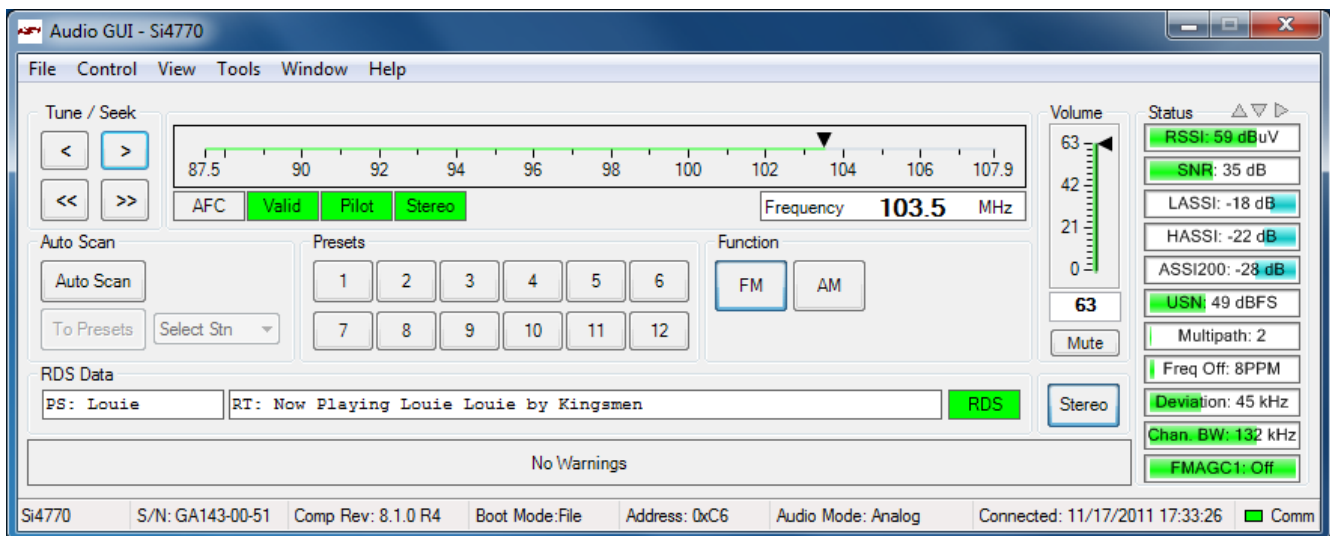

Figure 6. FM Receiver Window

4. Software

The Si477x Evaluation Kit includes a graphical user interface (GUI) to simplify tuner evaluation and configuration. This utility is useful both for demonstrations and for fine-tuning the various tuner properties and modes before coding firmware in the target system. The GUI is designed for Windows XP and later.

4.1. Installation

The software installation has two components: the GUI and the Microsoft.NET Framework. The board communicates via a USB HID interface, so no additional hardware drivers are needed.

Install the software components by the following steps:

1. Locate the installation software:
 - a. Open a window to the installation CD.
 - b. Open the **software** folder.
2. Install the software:
 - a. Start **setup.exe**.
 - b. Follow the on-screen prompts.

Notes:

- You may receive an error stating: "This setup requires the .NET Framework version 4.0." If so, install the .NET version provided on the CD (dotnetfx.exe).
- Important, release-specific notes may be included in the Readme.doc file. Please review this before finalizing the installation.
- Register at the Broadcast Audio Customer Support Page at www.silabs.com. All supporting documentation including data sheets, application notes, example code, and important layout guidelines are available only through the support site. Silicon Labs periodically updates versions of the content above and posts them there. All materials are covered under NDA.

4.2. Initialization

The Silicon Labs GUI will communicate with the evaluation board(s) and tuner(s) to identify which are in use. The applicable part numbers will be displayed under “device info” during initialization and on the front panel while the radio is in operation. Only the available application modes and tuners will be displayed by the GUI when initializing the tuner. Note that this user’s guide may show figures with application modes and features that may not be available depending upon the tuner part number or daughter card in use.

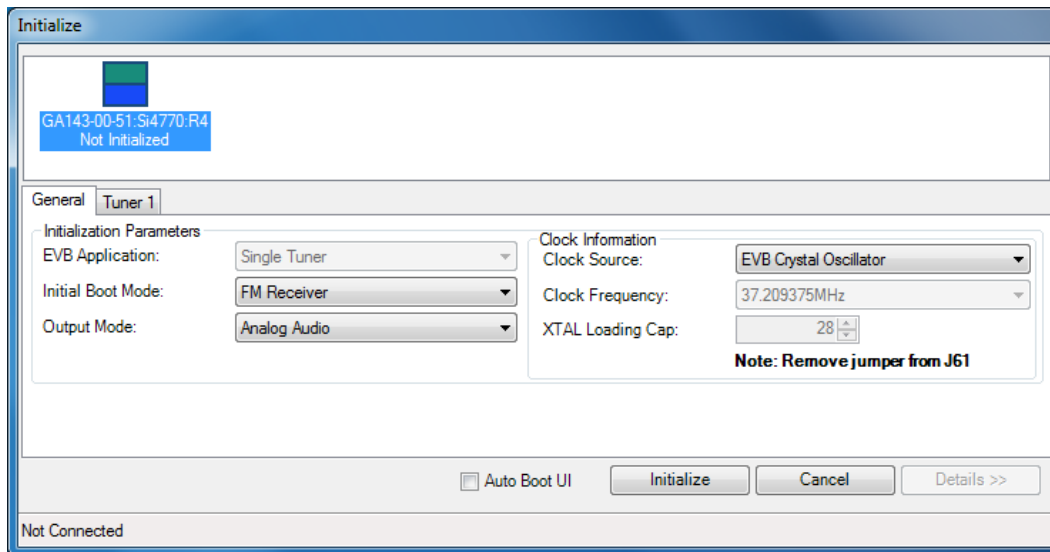

Figure 7. Initialization Window

1. Start the software by either using the desktop shortcut or from:
Start → Programs → Silicon Laboratories, Inc → Silicon Labs Audio GUI
2. Configure initialization options as shown in Figure 7. “Initialization Window”. A number of powerup options are available:
 - a. **EVB Application:** Select one of the following EVB application modes:
 - Single tuner
 - RDS/VICS
 - b. **Initial Boot Mode:** Selects whether the receiver will first start in FM Receive mode, AM Receive mode, etc.
 - c. **Clock Configuration:** This section displays information on the crystal oscillator clock frequency and crystal loading cap capacitance. The Clock frequency can not be modified in conjunction with a Quark Baseboard.
 - d. **Output Mode:** Configures tuner and EVB for either analog or MPX output through the HEADPHONE_OUT and L/R LINE_OUT jacks. Use the HEADPHONE_OUT jack for listening through headphones or powered speakers. Use the L/R LINE_OUT jack for low-distortion measurements. Other output modes are not supported by the Quark Baseboard.
 - e. **XTAL Loading Cap:** Indicates the crystal frequency trim capacitance. This is retrieved from an EEPROM on the daughtercard.

Additional options are available in the Firmware Configuration window, shown in Figure 9. “Firmware Configuration Window”.

- f. **Firmware selection:** The firmware for the tuner (or tuners in multi-tuner configurations) may be selected by selecting the appropriate Tuner tab as shown in Figure 9. “Firmware Configuration Window”. In particular,
- i. Select either the firmware image in the chip's NVRAM by selecting *From Device* or
 - ii. Select a firmware image from a list of options.
- g. **Part Number** and **I²C** address for the selected device. These are read back/configured automatically from the tuner or ID EEPROM on the daughtercard.
- h. **Default Mode:** UI default mode allows the selection of the UI configuration as a default for the part number, last used UI state, or you can select a configuration previously saved (see Figure 8). For saving a UI configuration, see Section 5.1.

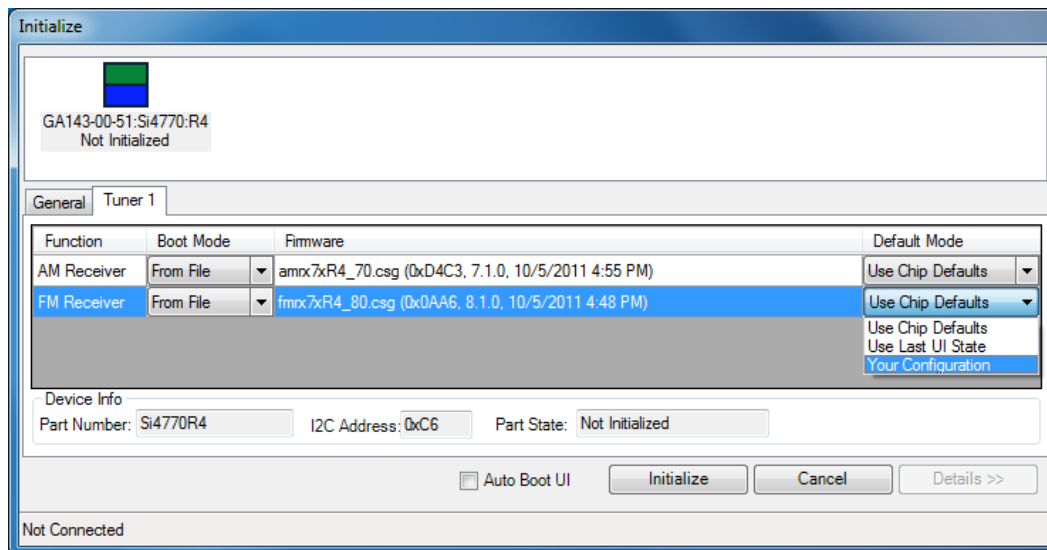

Figure 8. Default Mode Selection

Si477x-EVB

Note: If window displays "No Boards Found", check USB connections and power supply configuration.

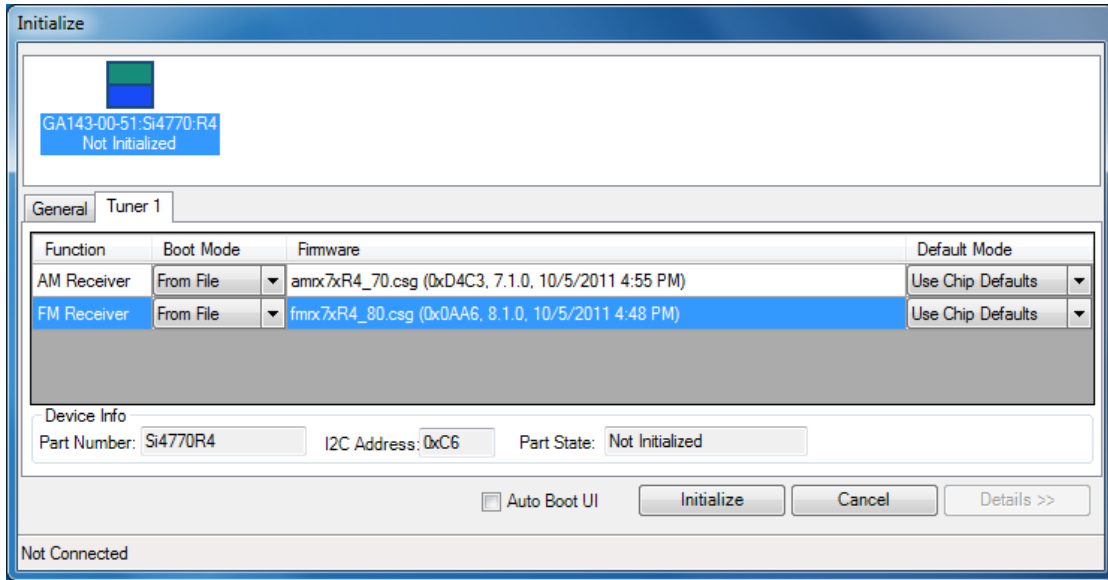

Figure 9. Firmware Configuration Window

5. Saving, Retrieving, and Deleting the Configuration State

This GUI feature allows the user to save, retrieve and delete the configuration state which contains the property values.

5.1. Saving the Current Configuration State

This feature allows the user to save the current configuration state which contains the property values.

1. Go to File→ State Management→ Save Current State as shown in Figure 10.

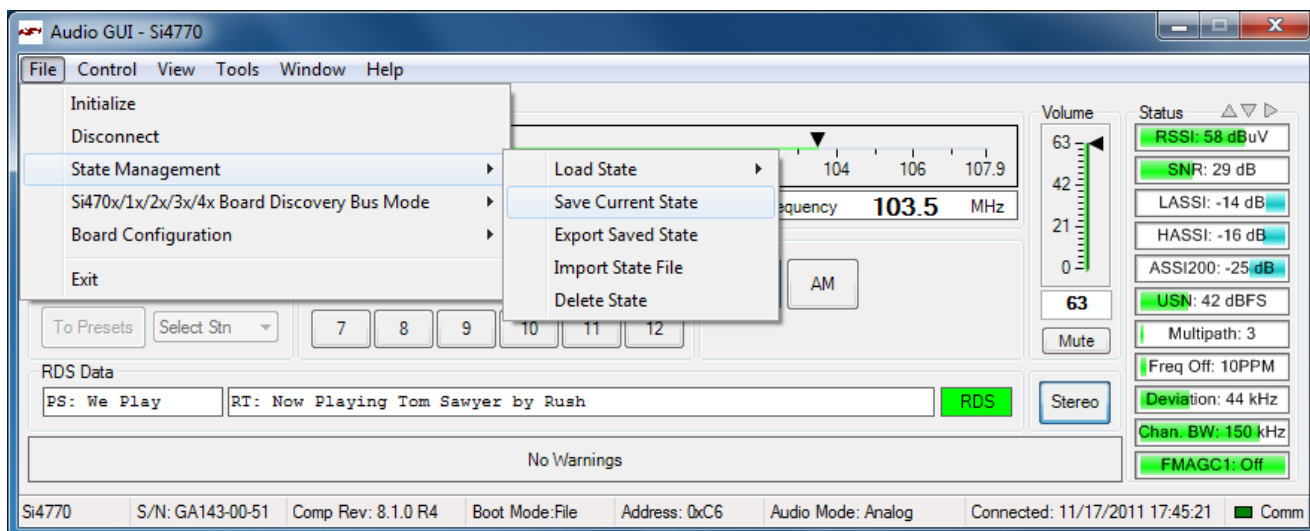

Figure 10. Saving Configuration State

2. Click on Save Current State and the Select Configuration window shown in Figure 11 will pop up. Enter the name of the configuration state and click OK. The current state called My Configuration which contains the property values is now saved.

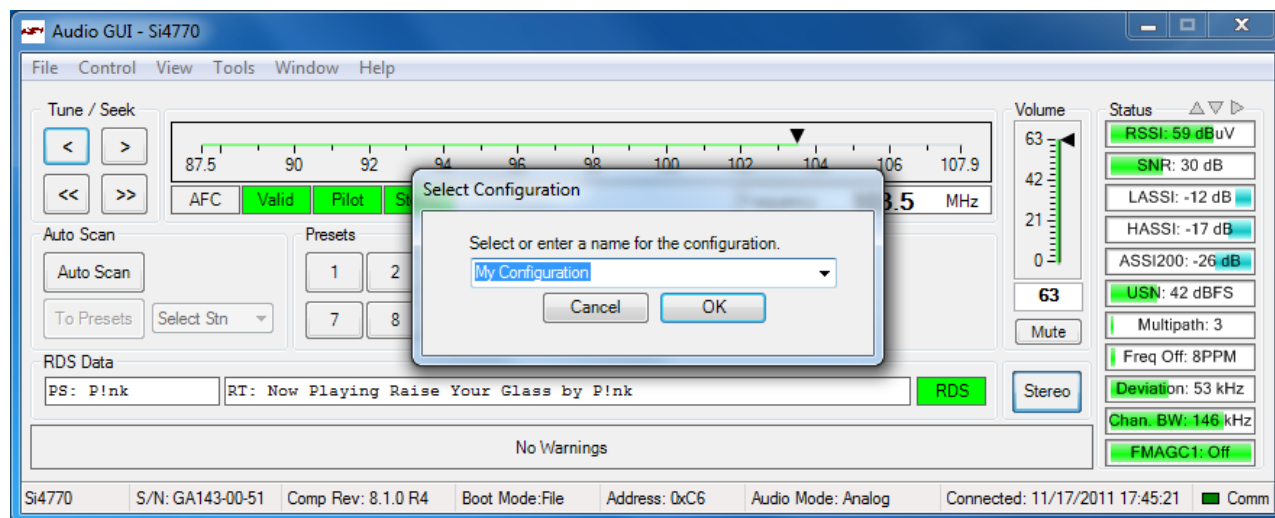

Figure 11. Naming a Configuration State During Save

Si477x-EVB

5.2. Retrieving the Configuration State

This feature allows the user to retrieve the configuration state.

1. Go to File → Initialize → Tuner 1 tab as shown in Figure 12. The different states which were saved before are available in the default mode for user selection.

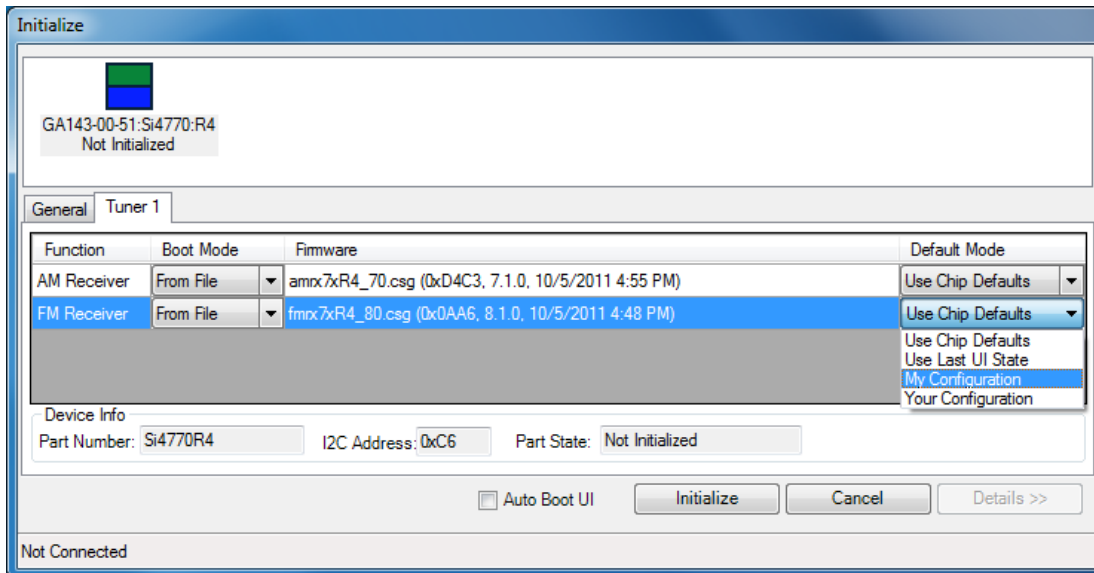

Figure 12. Saved Configuration State

2. In Figure 13 below configuration state My Configuration is selected. Once the selection is made, click on Initialize and the part will boot with the property values stored in the My Configuration state.

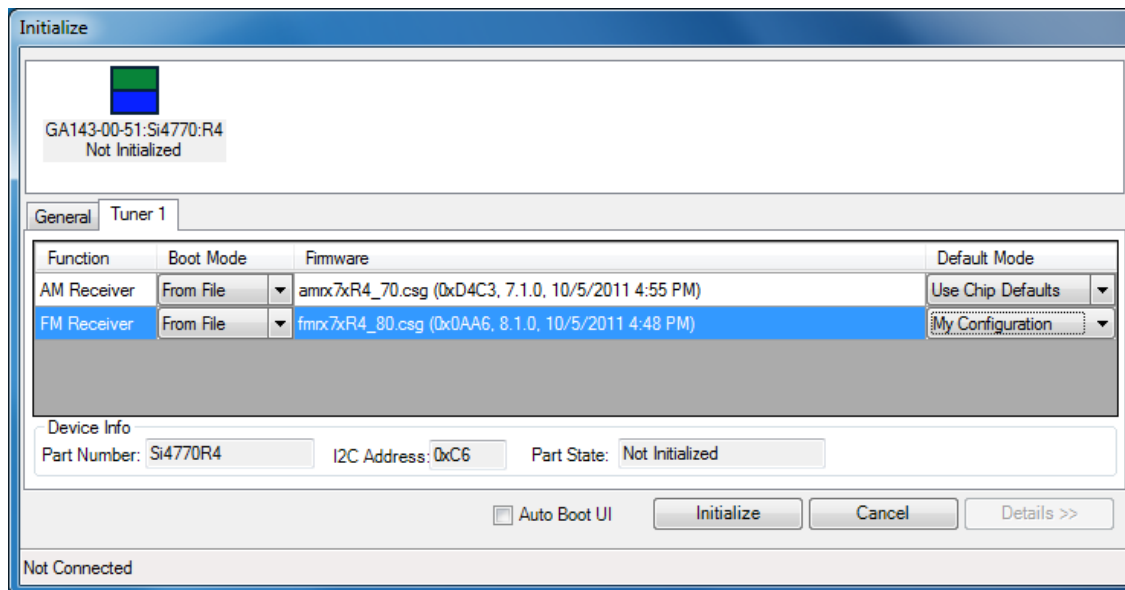

Figure 13. Power Up from Saved Configuration State

5.3. Deleting the Configuration State

This feature allows the user to delete the configuration state.

1. Go to File State Management → Delete State as shown in Figure 14.

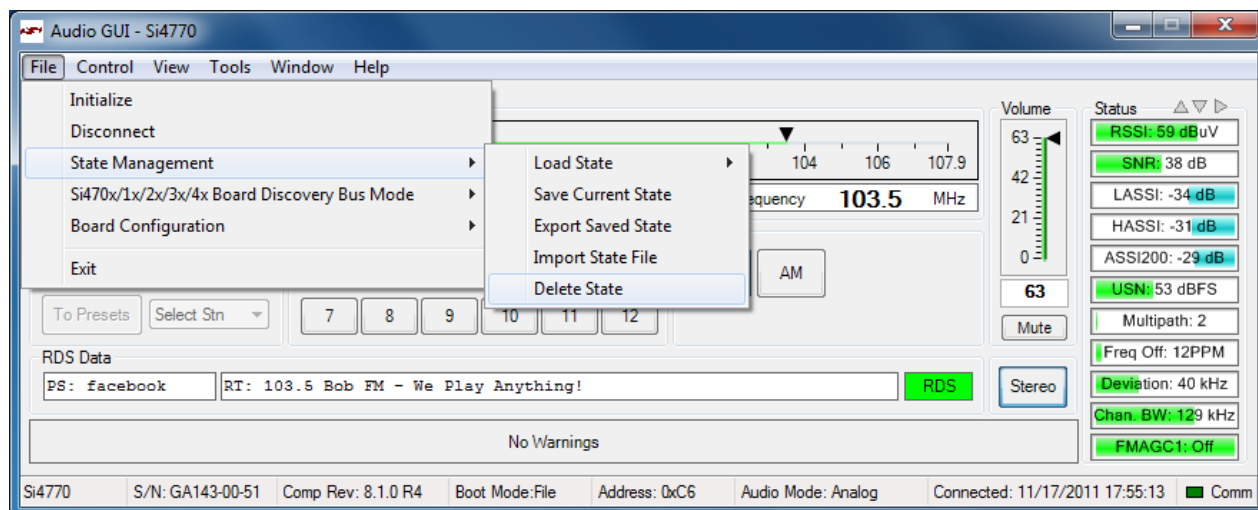

Figure 14. Delete Configuration State

2. Click on Delete state and the Delete Configuration window shown in Figure 15 will pop up. Select the configuration state you want to delete and click OK.

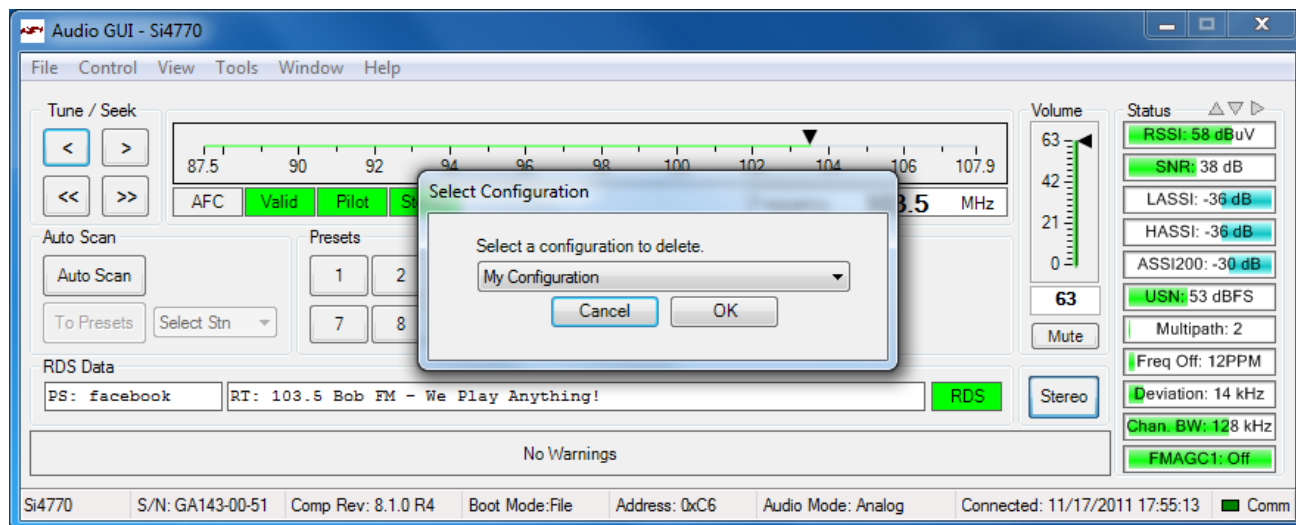

Figure 15. Selecting Configuration State to Delete

In addition to saving, retrieving and deleting the configuration state the GUI also gives the end user the ability to export the contents of the configuration state into a file, the contents of which can be viewed using a text editor and which can be imported to different machines to allow multiple users to test the tuner with the same configuration state.

5.4. Exporting Saved State

This feature allows the user to export the contents of the configuration state into a file.

1. Go to File→ State Management→ Export Saved State to export the saved state into a file as shown in Figure 16.

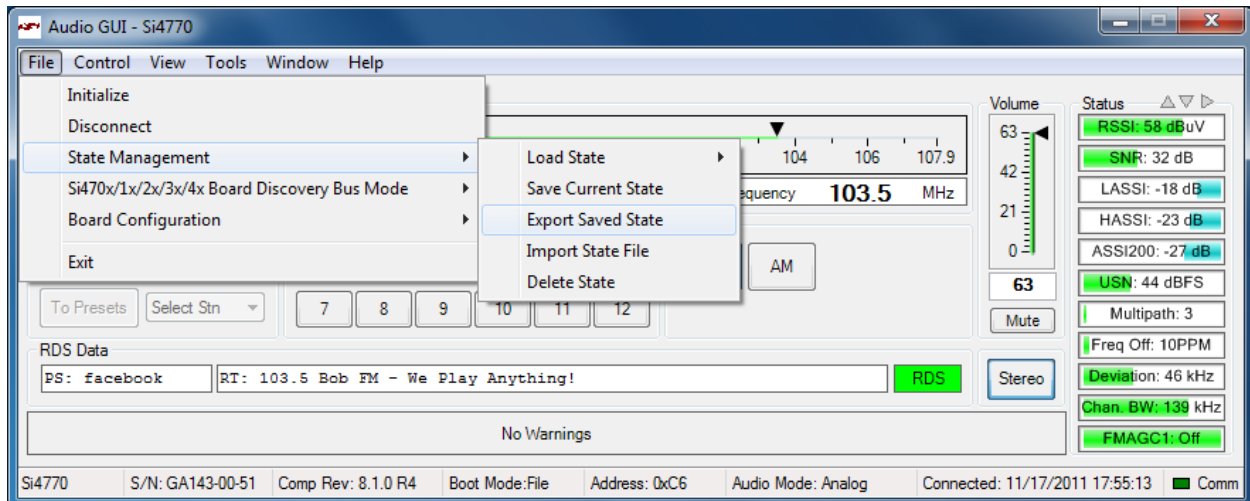

Figure 16. Exporting Saved State

2. Click on Export Saved State and the Select Configuration to Export window will pop up as shown in Figure 17.

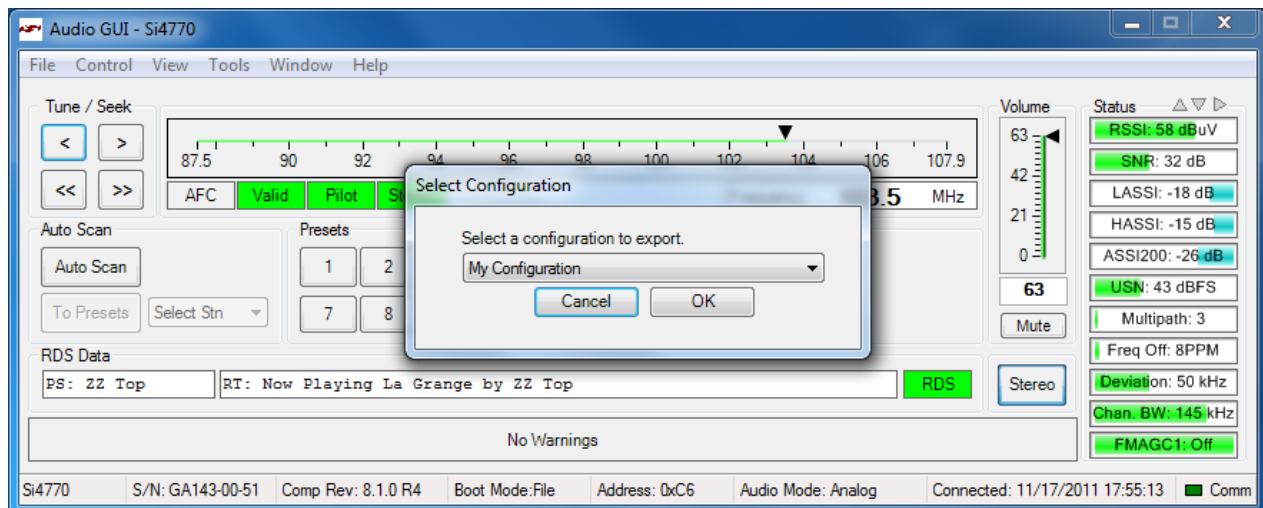

Figure 17. Selecting Configuration State to Export

3. Select the configuration state to export and click OK to save the configuration file with a .ini extension. This configuration file can now be opened in a text editor and saved to different machines. The contents of the configuration file will be displayed in a format as shown in Figure 18 below.

```
My Configuration - Notepad
File Edit Format View Help
//Type=Si477x
//Name=My Configuration
//ROMID=4
//Function=FMRX
//Requires=0xFFFF
//Flavor=7x
//ReadOnly=False
//ECRC=28C2F225
[Preferences_start]
ACF Control Source:RSSI
AGCState:On
AudioFilter_BQ1A1:1874529
AudioFilter_BQ1A2:16716001
AudioFilter_BQ1B0:4453131
AudioFilter_BQ1B1:14657907
AudioFilter_BQ1B2:1468280
AudioFilter_BQ2A1:1305086
AudioFilter_BQ2A2:15441877
AudioFilter_BQ2B0:4381446
AudioFilter_BQ2B1:1461852
AudioFilter_BQ2B2:113391
AudioFilter_BQ3A1:13427646
AudioFilter_BQ3A2:15910940
AudioFilter_BQ3B0:3656431
AudioFilter_BQ3B1:1085969
AudioFilter_BQ3B2:71519
AudioFilterState:On
Band Bottom (MHz):87.5MHZ
Band Top (MHz):107.9MHZ
Blend Fast Mult. Attack Time (mSec):16
Blend Fast Mult. Max Stereo Sep. (dB):45
Blend Fast Mult. Min Stereo Sep. (dB):0
Blend Fast Mult. Mono Thresh.:60
Blend Fast Mult. Release Time (mSec):4000
Blend Fast Mult. Stereo Thresh.:30
Blend Fast RSSI Attack Time (mSec):16
Blend Fast RSSI Mono Thresh. (dBuV):25
Blend Fast RSSI Release Time (mSec):4000
Blend Fast RSSI Stereo Thresh. (dBuV):55
Blend Fast USN Attack Time (mSec):16
Blend Fast USN Max Stereo Sep. (dB):45
Blend Fast USN Min Stereo Sep. (dB):0
Blend Fast USN Mono Thresh. (dBFS):27
Blend Fast USN Release Time (mSec):4000
Blend Fast USN Stereo Thresh. (dBFS):52
Blend Slow Mult. Attack Time (mSec):16
Blend Slow Mult. Max Stereo Sep. (dB):45
Blend Slow Mult. Min Stereo Sep. (dB):45
Blend Slow Mult. Mono Thresh.:60
Blend Slow Mult. Release Time (mSec):4000
Blend Slow Mult. Stereo Thresh.:30
Blend Slow RSSI Attack Time (mSec):16
```

Figure 18. Saved Configuration File

Si477x-EVB

5.5. Import State File

This feature allows the user to import the configuration state file which has been saved using Export Current State and hence use the same configuration state file on different machines.

1. Go to File→ State Management→ Import State File to export the saved state into a file as shown in Figure 19.

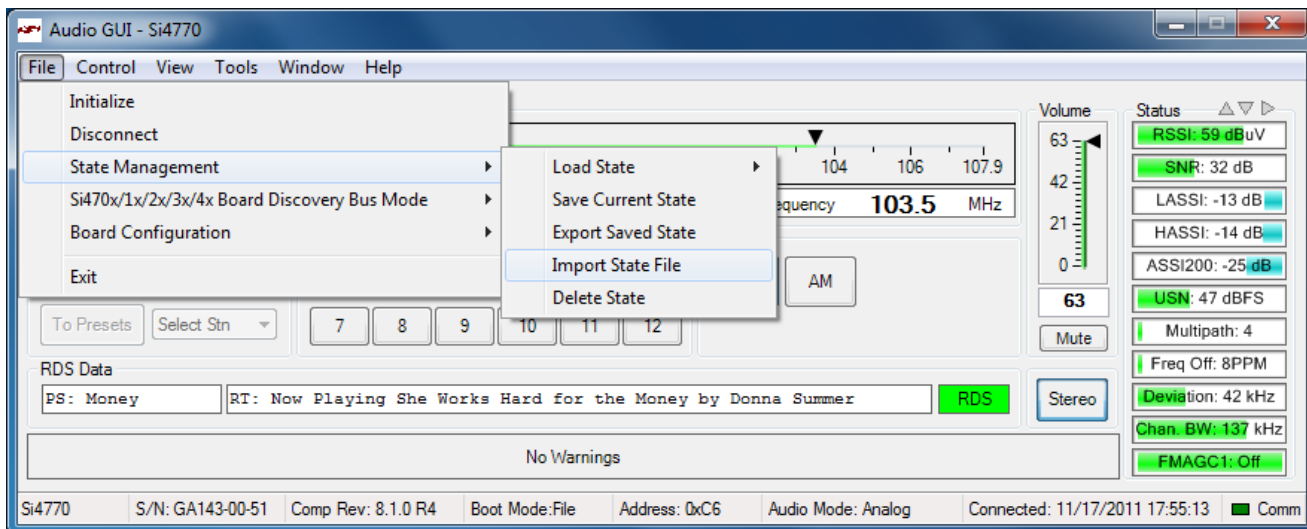

Figure 19. Import Configuration State

2. Select the file to import.
3. Once the state file is imported it will show up in the Default Mode of the Initialization window. In Figure 20 below the test.ini file was imported using Import State File and once that was done it shows up in the default mode in the Initialization window.

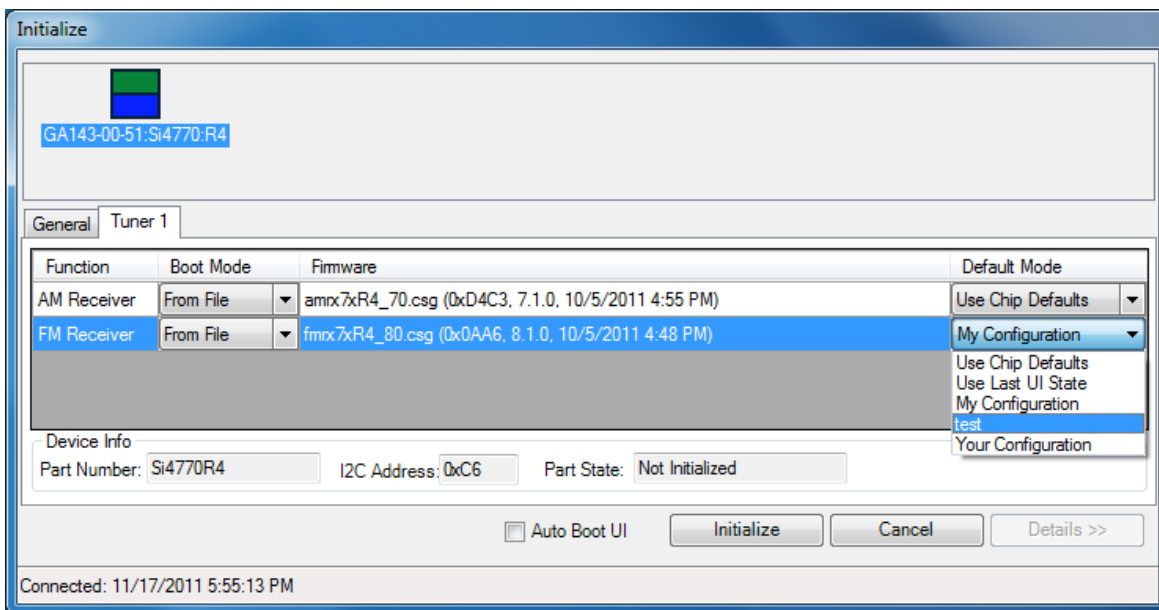

Figure 20. Selecting Imported State File

5.6. AM Receive Mode

Initialize the receiver as described in Section “4.2. Initialization”, selecting AM mode. The Tuner panel will appear as shown in Figure 21. “AM Tuner Window”.

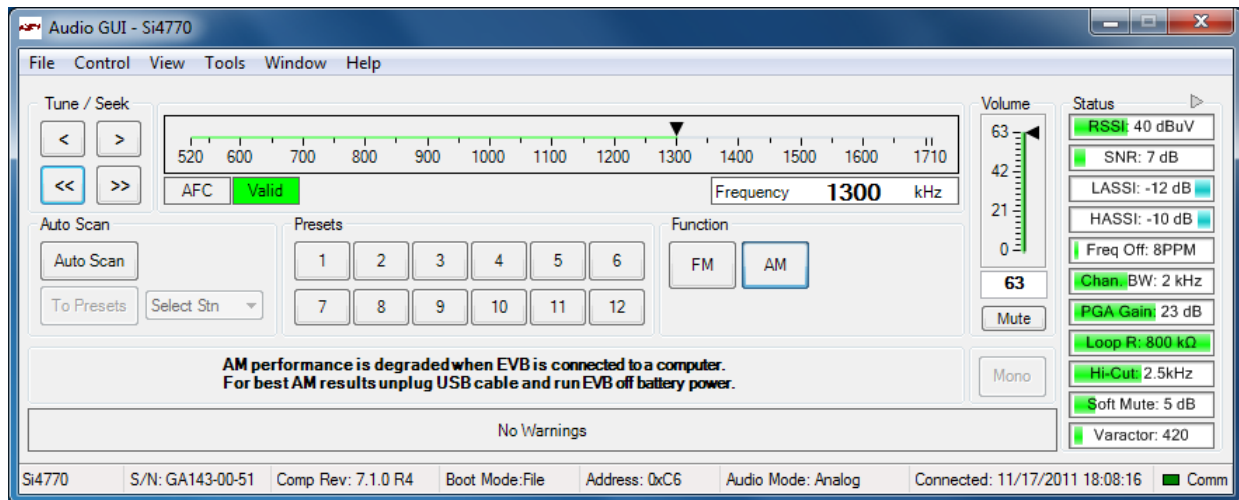

Figure 21. AM Tuner Window

- 1/2. **Frequency Numerical Window/Slider:** Use to set the receiver frequency. This also acts as an indicator for receive frequencies selected by seek or preset features. Note that frequency resolution is set by the Band and Spacing properties of the tuner via the Properties window.
3. **Tuning Increment/Decrement:** Adjusts receiver frequency in increments set by the Spacing property.
4. **Seek:** Executes tuner Seek command as configured by the applicable Seek/Tune properties.
5. **Auto Scan:** Executes sequential tuner Seek commands to cover the entire band. Valid stations are denoted beneath the tuner by red tick marks. Clicking the *To Presets* button automatically populates the presets with the strongest twelve stations found.
6. **Presets:** Each Preset button stores frequencies for convenient recall. Frequencies may be either automatically programmed using the Auto Scan as described above or may be manually set by selecting a frequency and holding the desired button until the frequency is memorized.
7. **Volume/Mute:** Sets the audio L/R output volume. The Mute button engages the AUDIO_MUTE property for both channels.

Note: Volume must be set to maximum (63) for all performance tests.

Si477x-EVB

8. **Status Indicators:** These indicators show the various metrics reported back to the user via either the AM_RSQ_STATUS or AM_ACF_STATUS API commands. Commonly used metrics include the following:
- RSSI:** The Received Signal Strength Indicator at the IC input. Note that this will vary from the actual antenna RSSI due to front end gains or losses.
 - SNR:** The Signal to Noise Ratio at the demodulator input. Note that this is not the SNR of the Audio output.
 - LASSI:** Adjacent Signal Strength Indicator. Indicates (signal + noise) at the low-side adjacent frequency in dB relative to the wanted carrier.
 - HASSI:** Adjacent Signal Strength Indicator. Indicates (signal + noise) at the high-side adjacent frequency in dB relative to the wanted carrier.
 - Freq Off:** Frequency offset of received signal.
 - Chan BW:** Receiver channel bandwidth.
 - Hicut:** Hicut corner frequency.
 - Soft Mute:** Indicates the attenuation applied.
9. **Status Indicator Undock:** Opens a separate window with status indicators, as shown in Figure 22. “AM Status Indicator Window”.

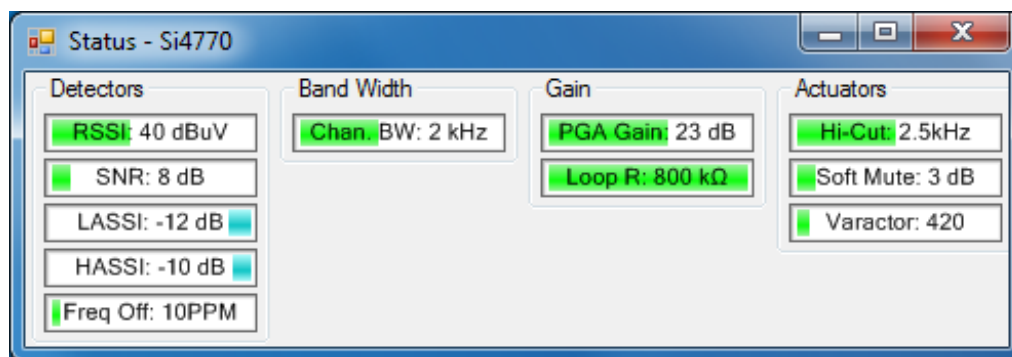

Figure 22. AM Status Indicator Window

10. **Band Selector:** Chooses which AM/SW/LW band to use for frequency tuning/seeking

Notes:

- Many of these mitigation engines and indicators are configured via properties.
- Refer to the Programming Guide for specific detail, including configuration, applicable ranges, etc.
- The USB power supply is provided for convenience only. Better performance will be attained using the external 9 V supply option.

5.7. FM Receive Mode

Initialize the receiver as described in Section “4.2. Initialization”, selecting FM mode. The Tuner panel will appear as shown in Figure 23. “FM Tuner Window”.

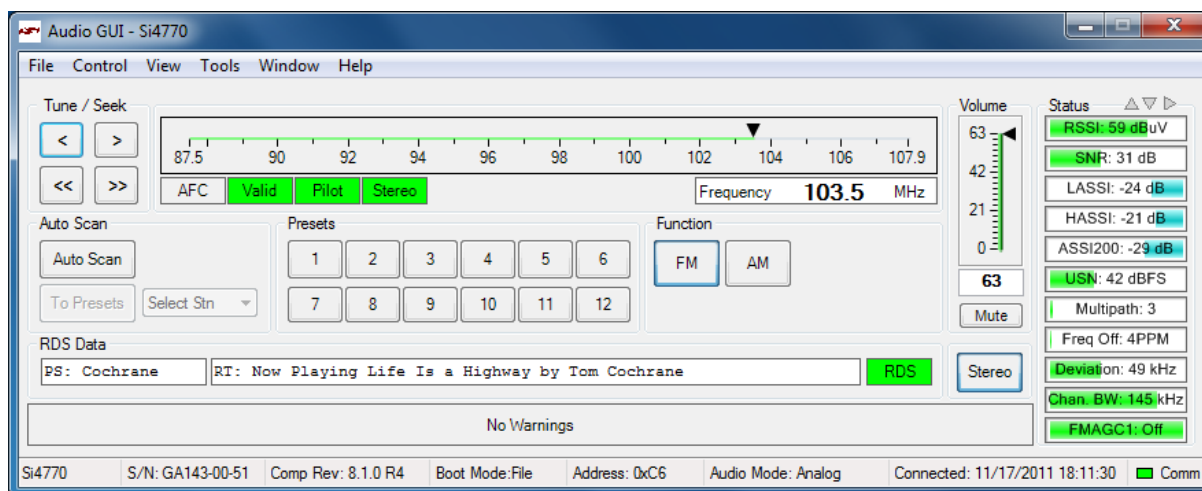

Figure 23. FM Tuner Window

1/2. **Frequency Numerical Window/Slider:** Use to set the receiver frequency. This also acts as an indicator for receive frequencies selected by seek or preset features. Note that frequency resolution is set by the Band and Spacing properties of the tuner via the Properties window.

3. **Tuning Increment/Decrement:** Adjusts receiver frequency in increments set by the Spacing property.

4. **Seek:** Executes tuner Seek command as configured by the applicable Seek/Tune properties.

5. **Auto Scan:** Executes sequential tuner Seek commands to cover the entire band. Valid stations are denoted beneath the tuner by red tick marks. Clicking the *To Presets* button automatically populates the presets with the strongest twelve stations found.

6. **Presets:** Each Preset button stores frequencies for convenient recall. Frequencies may be either automatically programmed using the Auto Scan as described above or may be manually set by selecting a frequency and holding the desired button until the frequency is memorized.

7. **Volume/Mute:** Sets the audio L/R output volume. The Mute button engages the AUDIO_MUTE property for both channels.

Note: Volume must be set to maximum (63) for all performance tests.

8. **Status Indicators:** These indicators show the various metrics reported back to the user via either the FM_RSQ_STATUS, FM_AGC_STATUS or FM_ACF_STATUS API commands. Commonly used metrics include:

RSSI: The Received Signal Strength Indicator at the IC input. Note that this will vary from the actual antenna RSSI due to front end gains or losses.

SNR: The Signal to Noise Ratio at the demodulator input. Note that this is not the SNR of the Audio output.

LASSI: Low Side Adjacent (100 kHz) Channel Strength Indicator reports the (Signal + Noise) power relative to the carrier.

HASSI: High Side Adjacent (100 kHz) Channel Strength Indicator reports the (Signal + Noise) power relative to the carrier.

ASSI200: The 200 kHz offset alternate signal strength indicator. Indicates (signal + noise) at the 200 kHz offset alternate channel in dB relative to the wanted carrier. Returns the maximum of high and low side alternate channels.

Si477x-EVB

USN: The Ultrasonic Noise indicator. Higher numbers indicate better signal quality.

Multipath: Multipath indicator. Higher numbers indicate more severe multipath impairment.

Freq Off: Frequency offset of received signal.

Deviation: FM deviation indicator

Channel BW: Receiver channel (IF) bandwidth.

Stereo: Indicates the Stereo/Mono blend ratio.

HI-Cut/Hi-Blend: Hicut mitigation applied to either the Left Plus Right (LPR) or Left Minus Right (LMR) audio signals.

Soft Mute: Indicates the soft mute attenuation applied.

FMAGC1, FMAGC2, PGA Gain: AGC indicators for FM AGC.

9. **Status Indicator Undock.** Opens a separate window with all status indicators for more convenient viewing as shown in Figure 24. "FM Status Indicator Window".



Figure 24. FM Status Indicator Window

10. **Stereo/Mono selector.** Force the receiver to mono mode by selecting this button. The tuner will automatically blend between stereo and mono mode when Stereo is selected.
11. **RDS Program Service and Radio Text indicators.** Displays received RDS strings.

Notes:

- Many of these mitigation engines and indicators are configured via properties.
- Refer to the Programming Guide for specific details, including configuration, applicable ranges, etc.
- The USB power supply is provided for convenience only. Better performance will be attained using the external 9 V supply option.

5.8. Configuring Tuner Properties

As described in the Programming Guide, various tuner aspects are configured through either a command/response or get/set property API interface. The GUI contains a window to help manage properties under *Window* → *Properties* as shown in Figure 25. “Properties Window”.

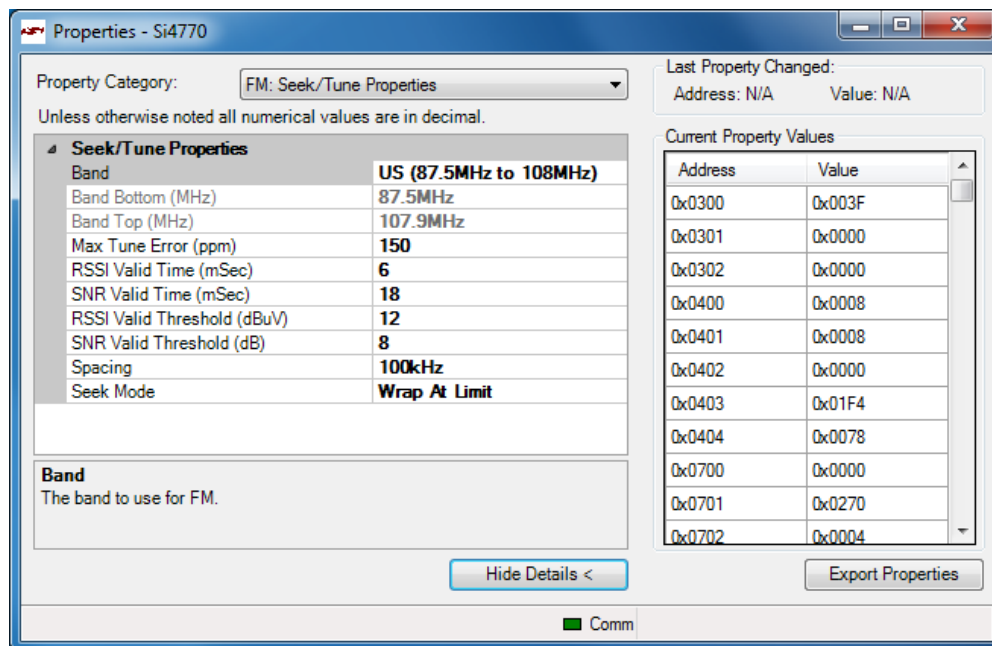

Figure 25. Properties Window

Properties are grouped by category. Properties specific to the Si477x device are prefixed with either FM or AM. FM RDS Settings, FM UI Settings, and AM UI Settings are categories that are used to control UI behavior but do not modify the property settings on the Si477x device. To see all properties associated with the Si477x device, choose FM: All or AM: All: All, depending on what mode the device is powered up into.

Most properties included in the API are also included in the properties window. Clicking on a particular property opens a brief description of the property and its arguments. Refer to the Programming Guide for detailed information on the properties and values.

Property addresses and values can be displayed or hidden using the Display/Hide Details button. When displayed, all of the current properties can be viewed or exported to a file (using the Export Properties button) and the last property changed is displayed. By clicking the Export Properties button shown in Figure 25, the properties can be exported to a .csv file.

Si477x-EVB

5.9. Register Read/Write

The software's graphical user interface and property windows provide an easy, intuitive method of configuring the device. In development, however, it is often useful to have low-level bitwise read/write interface to the tuner. The GUI provides this interface under *Window* → *Register Map*.

Figure 26. "Register Map Window" shows an example read/write operation. The FM_RSQ_STATUS request is sent with an ARGument of 0x00. The reply returned in the RESPonse fields.

Refer to the Programming Guide for detailed information on the register definitions and their arguments and responses.

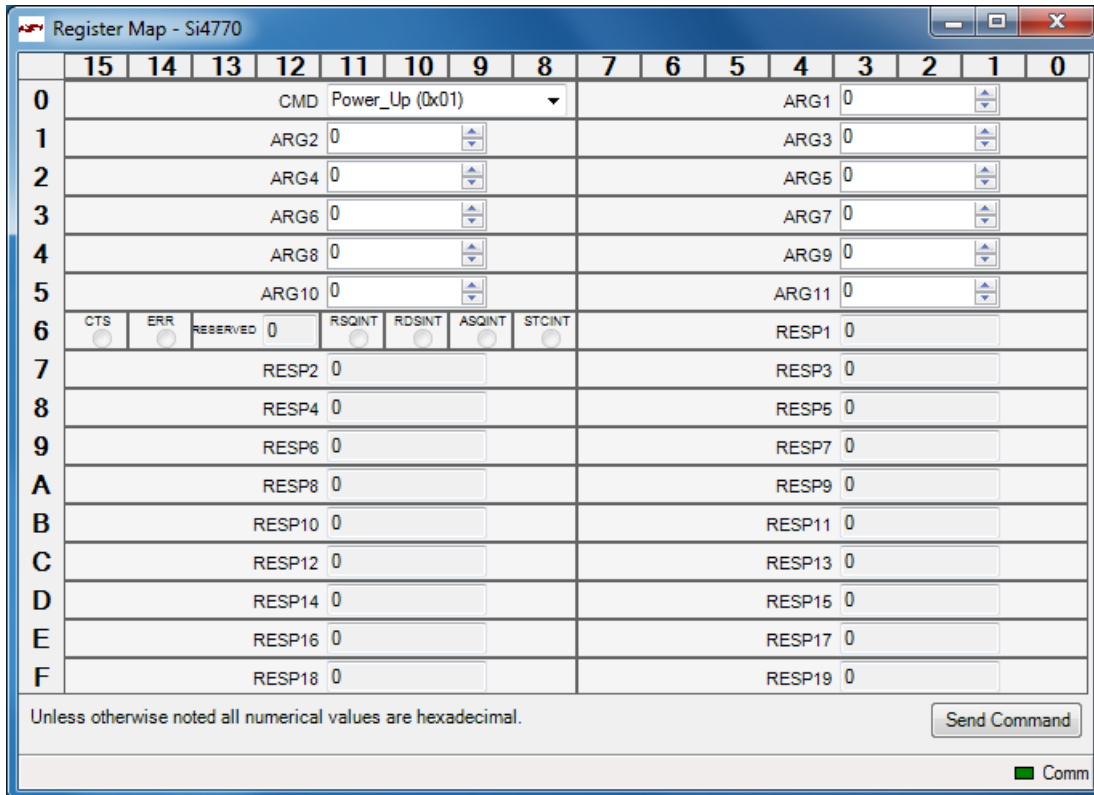

Figure 26. Register Map Window

5.10. Other Useful Tools

5.10.1. RSSI/SNR Graphing Utility

The Graphing utility Window → RSSI/SNR Graph provides a scan of user selectable metrics versus frequency. Graphing options include RSSI, SNR, Low Adjacent Channel Strength (LASSI), and High Adjacent Channel Strength (HASSI). These metrics can be individually selected for display. A line or bar graph style can be chosen and markers indicating valid stations and their frequencies can be displayed. Once the preferred graphing and displays have been selected, click the “Draw” button.

Figure 27 shows an example scan in the FM band. Stations above the red line meet the RSSI threshold for valid stations. The SNR page shows a complementary scan of SNR values across the band as well as the SNR threshold for valid stations.

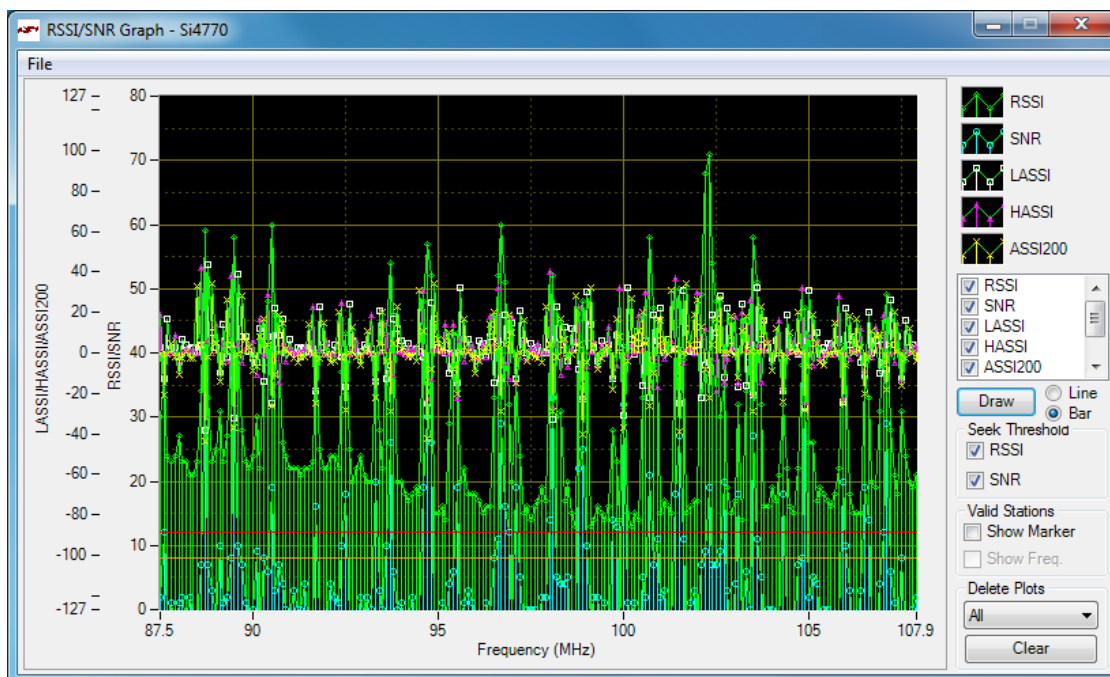

Figure 27. RSSI/SNR Graphing Utility

5.10.2. Blend/Hicut/Soft Mute Configuration Helper

The mitigation engines such as FM stereo/mono blend, hi-cut, hi-blend, and soft mute have configurable low- and high-end thresholds. These thresholds may be configured numerically through the Properties page or graphically through the Configuration Helper.

Figure 28 shows an example of the Configuration Helper set to display FM stereo/mono blend based on RSSI. This example also provides the ability to set the Fast and Slow metrics on the same screen. If a configuration setting does not have Fast and Slow metrics available, only one graph and column of configurable values will appear. On both graphs the green line depicts the blend (in percent stereo). The green point shows the current operating point of the receiver (30 dB μ V RSSI which results in 18% stereo given the property settings). The cyan line reflects the actual reported stereo value (14%) from the Si477x device which is mitigated by all the metrics (RSSI/Multipath/USN) in this example. Since the cyan line is tracking the green point or RSSI mitigated blend, the device is limiting stereo based on RSSI in this example.

When selecting a mitigation control item, the description text is updated automatically. The name of the property being changed is displayed in bold. The property can then be found in the property window by finding the property with the same name being displayed in the configuration helper.

Changes made to this page are applied to the tuner immediately, making it a useful tool in real-time configuration of the mitigation engines.

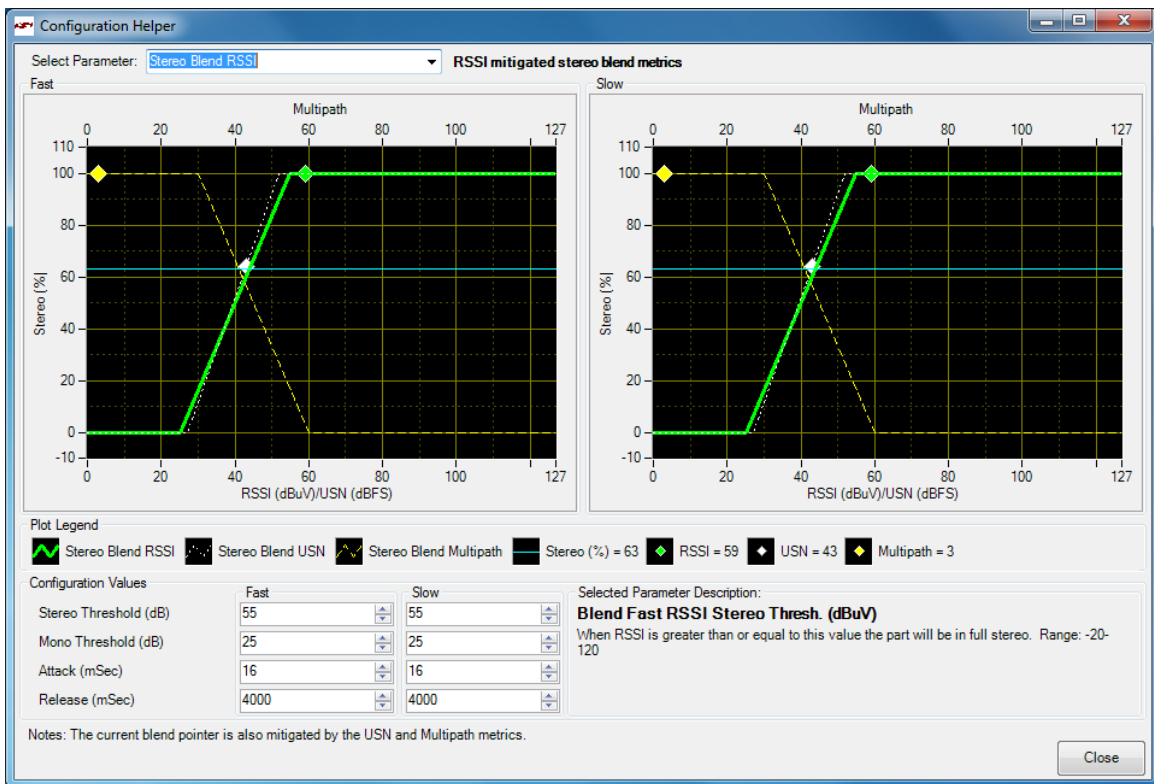

Figure 28. Configuration Helper

5.10.3. RDS Receive Data

The Si477x UI features tools help in capturing and analyzing RDS performance.

The first is the RDS Receive Data window (under menu *Window* → *RDS Receive Data*). This shows various RDS metrics such as the decoded RDS fields, group counters, and performance statistics. This is shown in Figure 29.

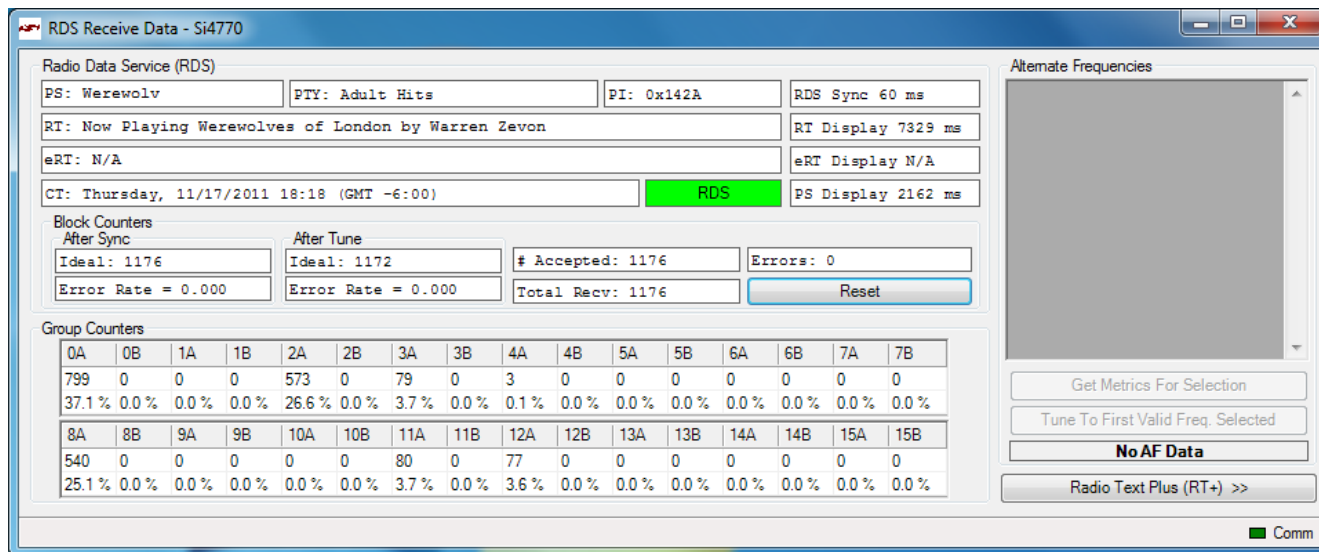

Figure 29. RDS Receive Data Window

The second is a graphical display of the RDS group counter information, shown in Figure 30. This window is available under menu *Window* → *RDS Group Counters*.

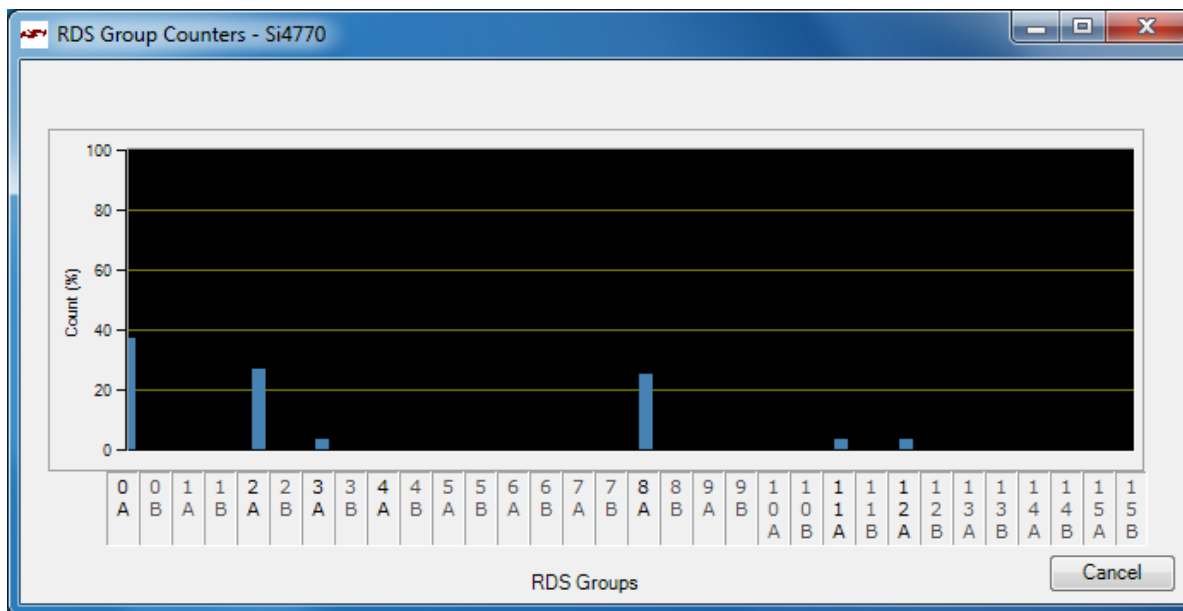

Figure 30. RDS Group Counter Window

Si477x-EVB

6. Hardware Description

The evaluation hardware consists of two components: a daughtercard and a baseboard.

Note: Refer to Rev. 0.1 of this document if the Si475x/6x Baseboard is supplied.

6.1. Feature Overview

Figure 31. “EVB Features Using Quark Baseboard” shows various connections, jumpers, adjustments, and features for an EVB using a Quark baseboard.

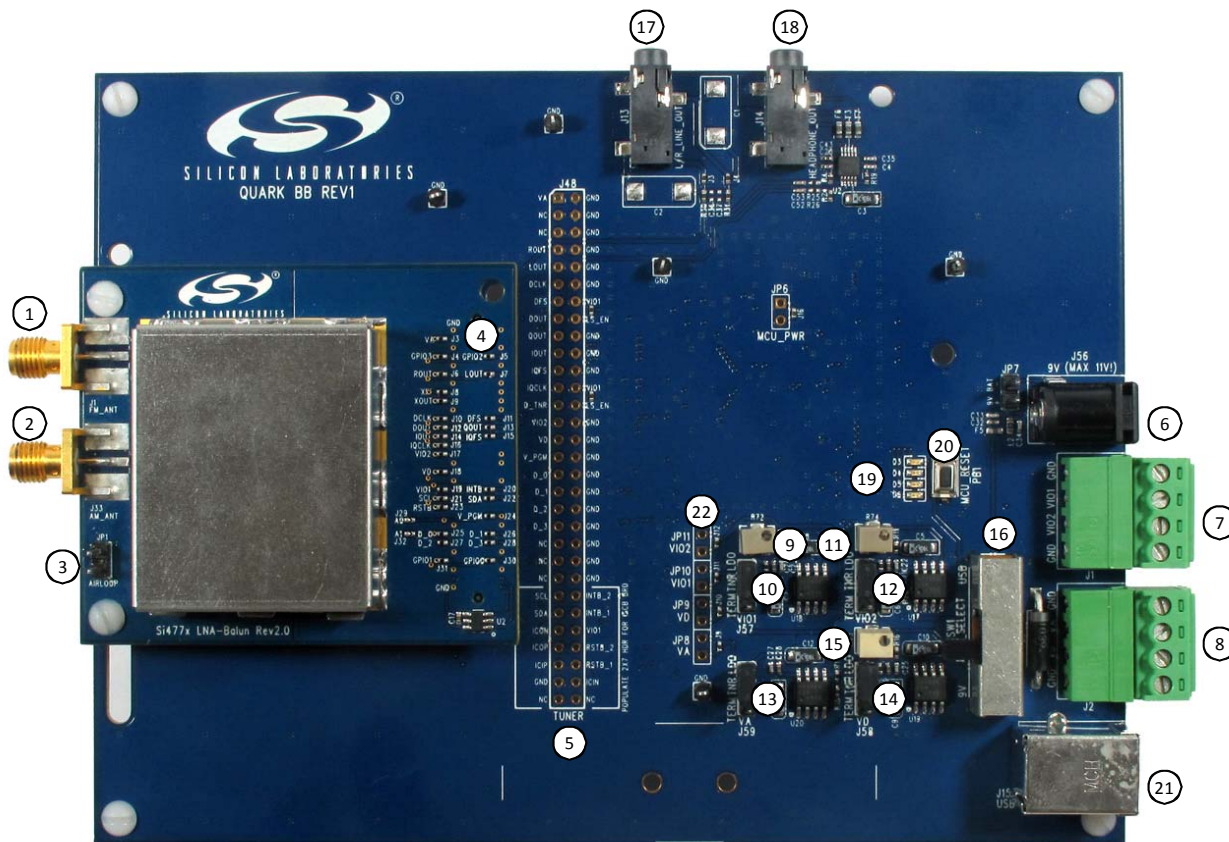

Figure 31. EVB Features Using Quark Baseboard

Table 1. EVB Feature Descriptions

	Reference	Description
1	J1	FM antenna connector/test conductor.
2	JP1	AM antenna connector
3	J33	AM test connector
4		Tuner pin/net connection points.
5	J48	Tuner pin/net connection points.
6	J56	9 V input to LDOs. Maximum 11 V.
7	J1	VIO 1/2 inputs. Source with bench power supply if on-board LDOs are not used.
8	J2	VA/VD inputs. Source with bench power supply if on-board LDOs are not used.
9	R72	VIO1 LDO adjust. (1.2–3.6 V, nominal 3.3 V)
10	J57	Selects tuner VIO1 source from LDO or TERMINal.
11	R74	VIO2 LDO adjust. (1.7–3.6 V, nominal 3.3 V)
12	J60	Selects tuner VIO2 source from LDO or TERMINal.
13	J59	Selects tuner VA source from fixed 5 V LDO/USB or TERMINal.
14	J58	Selects tuner VD source from LDO or TERMINal.
15	R73	VD LDO adjust. (2.7–3.6 V, nominal 3.3 V)
16	SW1	Selects USB or 9 V input to LDO. Note that in USB position PC 5 V sources VA directly which could result in decreased performance. Center position is off.
17	J13	L/R_LINE_OUT. L/R lineout (direct from tuner). (Rev 3 and later) Buffered/110 kHz lowpass filtered L-ch analog output when in MPX mode. (Rev 2)
18	J14	HEADPHONE_OUT. Buffered headphone out. (Rev 3 and later) Buffered, 30 kHz lowpass filtered L, R channel outputs when in L/R audio mode. (Rev 2)
19	D3-D6	LEDs.
20	PB1	MCU Reset.
21	J15	USB connector.
22	J9-J12	Current measurement jumpers.

6.2. Daughtercard

Each evaluation kit will be provided with an Si477x daughtercard.

Each daughtercard contains the minimal application circuit, including the following:

- Si477x Tuner IC
- RF Input circuitry
- Crystal
- EEPROM for serial number, calibration constants, and crystal information

Each daughtercard features a number of test points with direct access to the tuner signal pins. These signals may be disconnected from the baseboard connector by removing either a 0 Ω jumper or by removing a solder dot on a printed chevron pattern. Small vias allow for connection via wire-wrap wire.

The reference frequency is generated by the on-chip crystal oscillator by default. If desired, the reference clock may be sourced by the baseboard oscillator or an external generator by removing the crystal and inserting a 0.1 μ F capacitor to bridge the connection.

Refer to "7. Hardware Schematics and PCB Layout" on page 32 for daughtercard schematics and PCB layouts.

6.3. Baseboard

The Quark baseboard contains all support circuitry, including the following:

- Power supplies: all four Si477x supplies derived from USB 5 V or wall pack 9 V supplies
- USB HID-based communications interface via C8051F340 microcontroller
- Test points for all tuner interface I/O lines
- Direct and buffered L/R/MPX analog outputs

6.3.1. Power Supplies

On-board LDOs generate VA, VD, VIO1, and VIO2 supplies for the tuner. Three of these, VD, VIO1, and VIO2, are adjustable via trimpot. Level translation to other blocks, such as the microcontroller, is via discrete translators.

Switch SW1 selects the LDO configuration as sourced from the 9 V coaxial connector or the USB 5 V supply from the PC. When in the USB position, the 5 V analog supply to the tuner is derived directly from the PC USB supply.

Notes:

- The USB power supply option is provided for convenience but may result in decreased RF performance due to PC power supply noise and lack of regulation between PC and the tuner's analog power supply. Regulation inaccuracy and cable loss may result in a VA supply voltage below specification.
- Ensure any wall power supply has a maximum output voltage of less than 11 V. Higher voltages will engage a clamping diode and may damage the LDOs.

Jumpers, shown highlighted in Figure 32. "Power Supply Jumpers", select each tuner supply's source as either the on-board LDO (shown) or external (via J1/J2).

Tuner supply currents may be measured by opening jumpers J9-J12 and inserting an ammeter in positions JP8-JP11.

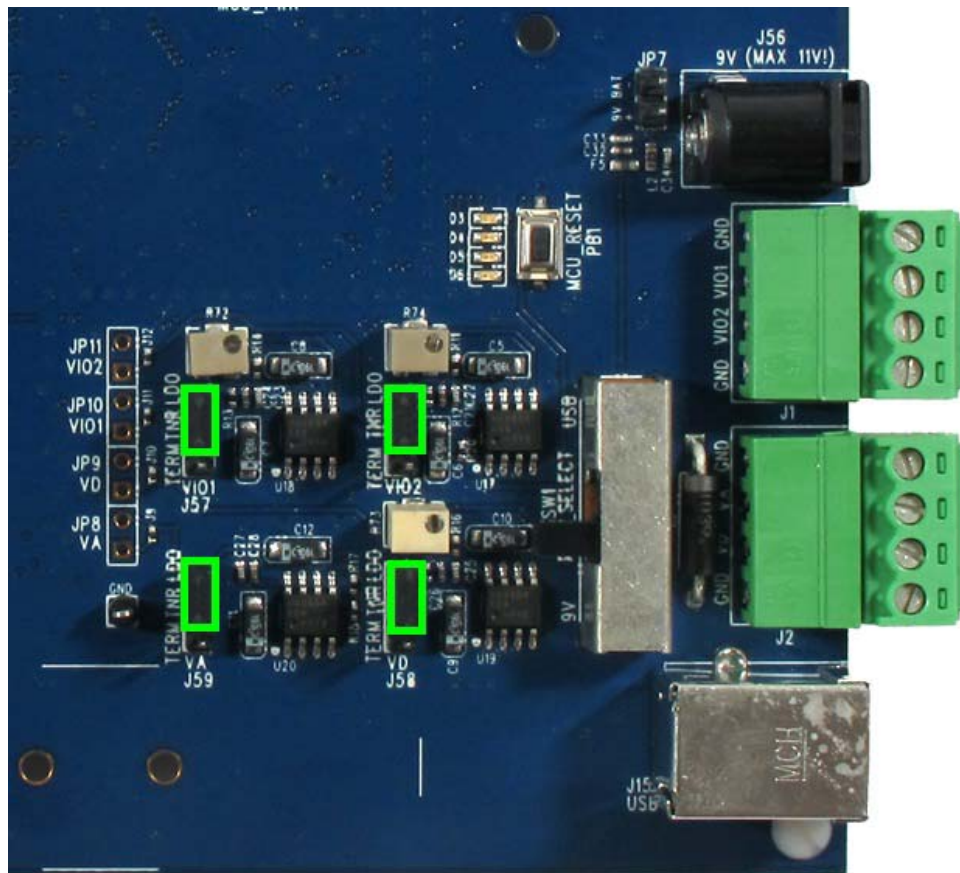

Figure 32. Power Supply Jumpers

6.3.2. Microcontroller/USB Interface

Communication to the tuner and configuration is through firmware on a Silicon Laboratories C8051F340 USB microcontroller. This device translates USB commands via HID interface to I²C control words to the tuner.

PB1 resets the microcontroller.

LED's D3–D6 are driven by the microcontroller. The green LED D4 lights when the microcontroller has booted.

The USB connection may be disconnected once the tuner is configured. Tuner settings will persist until reset or the power is removed.

Si477x-EVB

6.3.3. Headphone Amplifier/Buffer

Left and Right audio outputs are buffered and lowpass filtered by on-board amplifiers in Figure 33. "Audio Output". The software automatically selects the L/R audio-band output when AM or FM modes are selected. The left channel/MPX output is selected in MPX mode only.

Unbuffered L/R outputs are available at the debug header J48.

Note: Use L/R outputs directly from tuner for THD, SINAD, and stereo imbalance measurements. The headphone amplifier may degrade performance.

The analog L/R and MPX outputs are available at two 3.5 mm jacks. The function of each jack varies by baseboard revision.

The left jack is a direct, dc-coupled L/R/MPX output from the tuner. This output should be used for all low-distortion laboratory measurements. The right jack is an ac-coupled, unity-gain-buffered L/R output for listening through headphones or powered speakers.

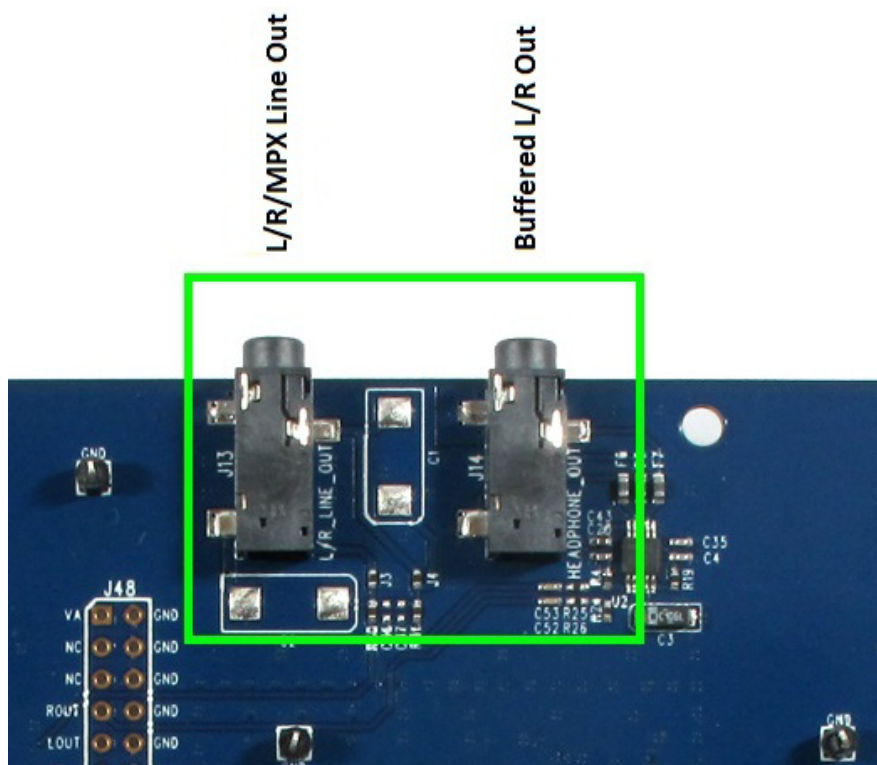

Figure 33. Audio Output

6.4. Si4770Module-A-EVB

Separately from the Si477x-EVB kit, user's may also order an Si4770Module-A-EVB kit. The Si4770Module-A-EVB kit consists of an Si4770 Module and Si477x Interposer card. Together, these serve in place of a daughter card on an Si477x EVB. Alternatively, the Si4770 Module can be installed into a user-created system with a compatible pinout. To use the Si4770Module-A-EVB in conjunction with an Si477x EVB, connect the module, interposer card, and baseboard as shown in Figure 34.

Note: The Si4770 Module is configured by default for an AM Loop Antenna connected through the Si47xx Interposer card. For optimum results in conducted tests through the AM Test SMA connector, remove transformer T2 from the AM signal path on the Si4770 Module.



Figure 34. Si4770Module-A-EVB Module and Interposer Card

7. Hardware Schematics and PCB Layout

This section contains schematics, PCB layouts, and Bills of Material for all daughtercards (DCs) and the baseboard (BB).

7.1. Si477x Daughtercard Rev 2.0

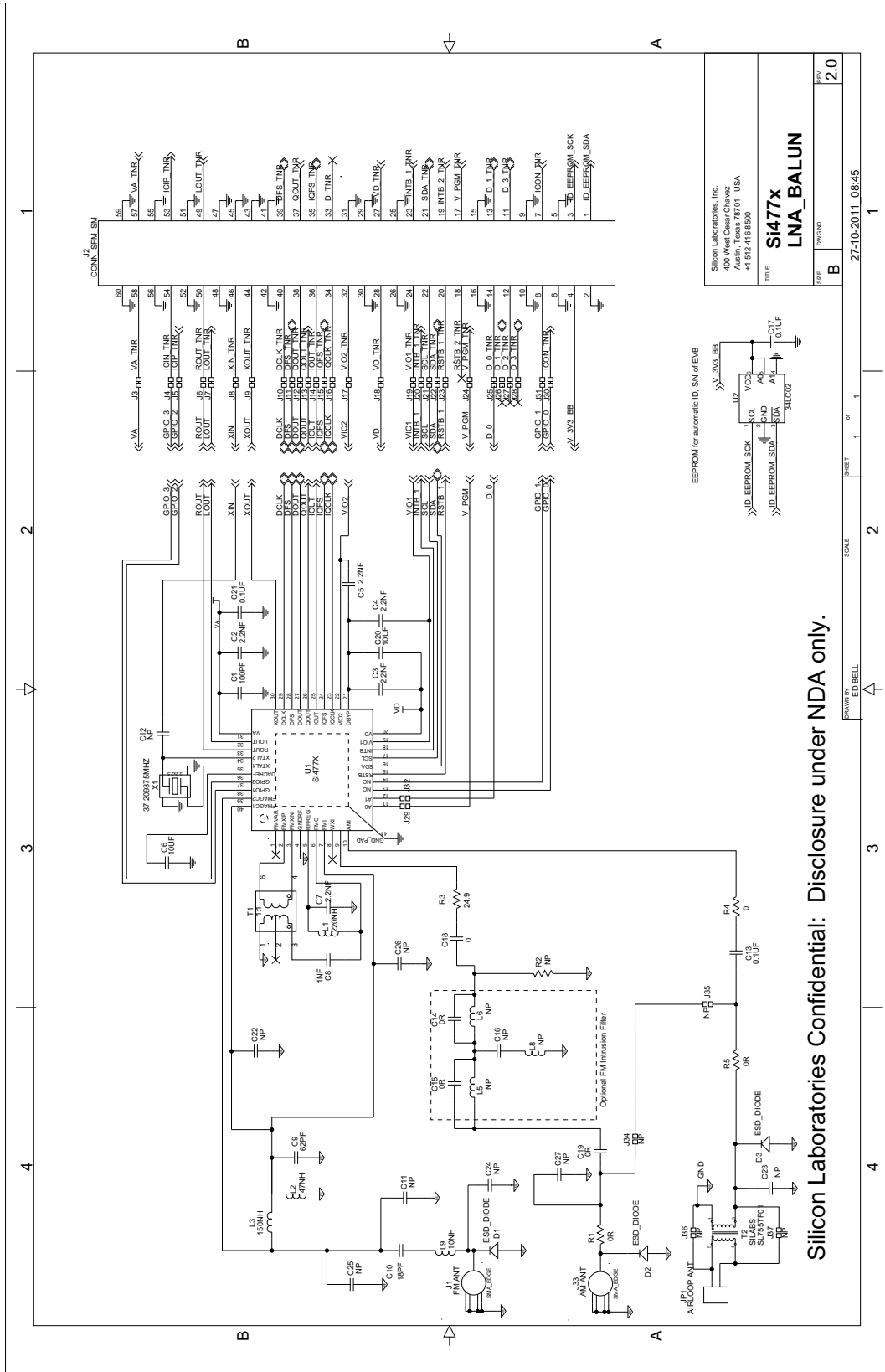

Figure 35. Si477x Rev 2.0 Schematic

Silicon Laboratories Confidential: Disclosure under NDA only.

Si477x-EVB

Table 2. Si477x DC Rev 3.0 Bill of Materials

Qty	Ref Des	Description	Value	Mfr	Mfr Part Number
1	C1	CAP,SM,0402	100PF	MURATA	GRM1555C1H101JZ01
1	C10	CAP,SM,0402	18PF	MURATA	GRM1555C1H180JZ01
8	C11,C12,C22, C23,C24,C25, C26,C27	CAP,SM,0402	NP		
3	C13,C17,C21	CAP,SM,0402	0.1UF	MURATA	GRM155R71A104KA01D
5	C2,C3,C4,C5, C7	CAP,SM,0402	2.2NF	MURATA	GRM155R71H222KA01
2	C6,C20	CAP,SM,6.3V, X5R,0603	10UF	MURATA	GRM188R60J106ME47D
1	C8	CAP,SM,0402	1NF	MURATA	GRM155R61H102KA01
1	C9	CAP,SM,0402	62PF	MURATA	GRM1555C1H620JD01
3	D1,D2,D3	ESD PROTECTOR,SM		DIGIKEY	PESD0402-140TR-ND
2	J1,J33	CONN, SMA, EDGEMOUNT		YAZAKI	RA2EJ2-6G
1	J2	CONN,SM,2X30		SAMTEC	SFM-130-02-S-D-A
1	JP1	CONN,TH,HEADER,1X2		SAMTEC	HTSW-101-07-G-D
1	L1	IND,SM,0603	220NH	MURATA	LQW18ANR22G00
1	L2	IND,SM,0603	47NH	MURATA	LQW18AN47NG00
1	L3	IND,SM,0603	150NH	MURATA	LQW18ANR15G00
1	L9	IND,SM,0603	10NH	MURATA	LQW18AN10NJ00D
2	R1,R4	RES,SM,0402	0R		
1	R5	RES,SM,0402	NP		
1	T1	BALUN,1:1, TOKO		TOKO	#458PT1566
1	T2	TRANSFORMER,THRU-HOLE		SILABS	SL755TF01
1	U1	IC,SM,SI4770,MLP40		SILICON LABO- RATORIES	SI477x
1	U2	IC,SM,RAM		MICROCHIP	34LC02
1	X1	XTAL,SM,3.2 X 2.5 MM	37.209375 MHz	TAI_SAW	TZ1522A

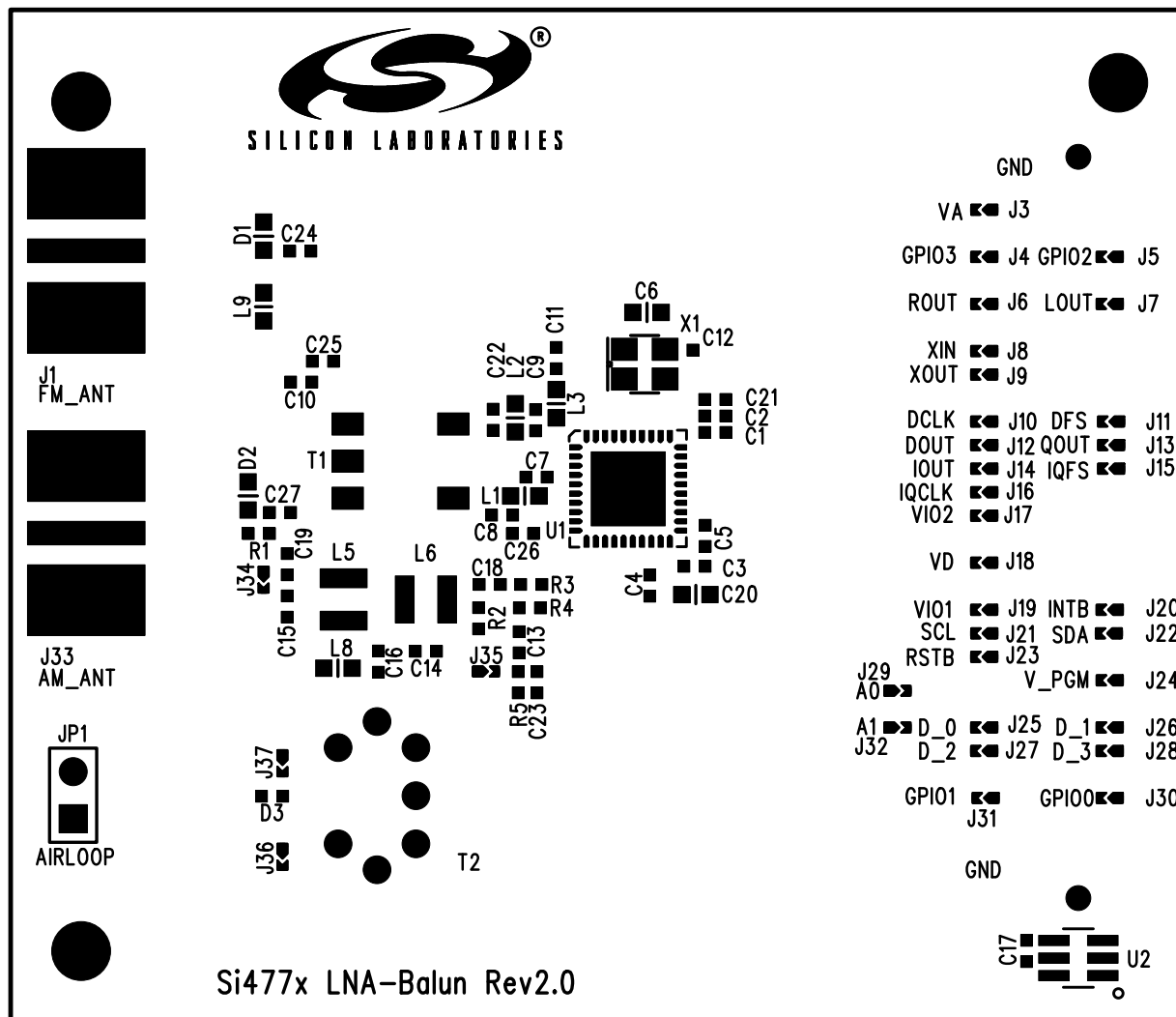

Figure 36. Si477x Daughtercard Rev 2.0 Silkscreen

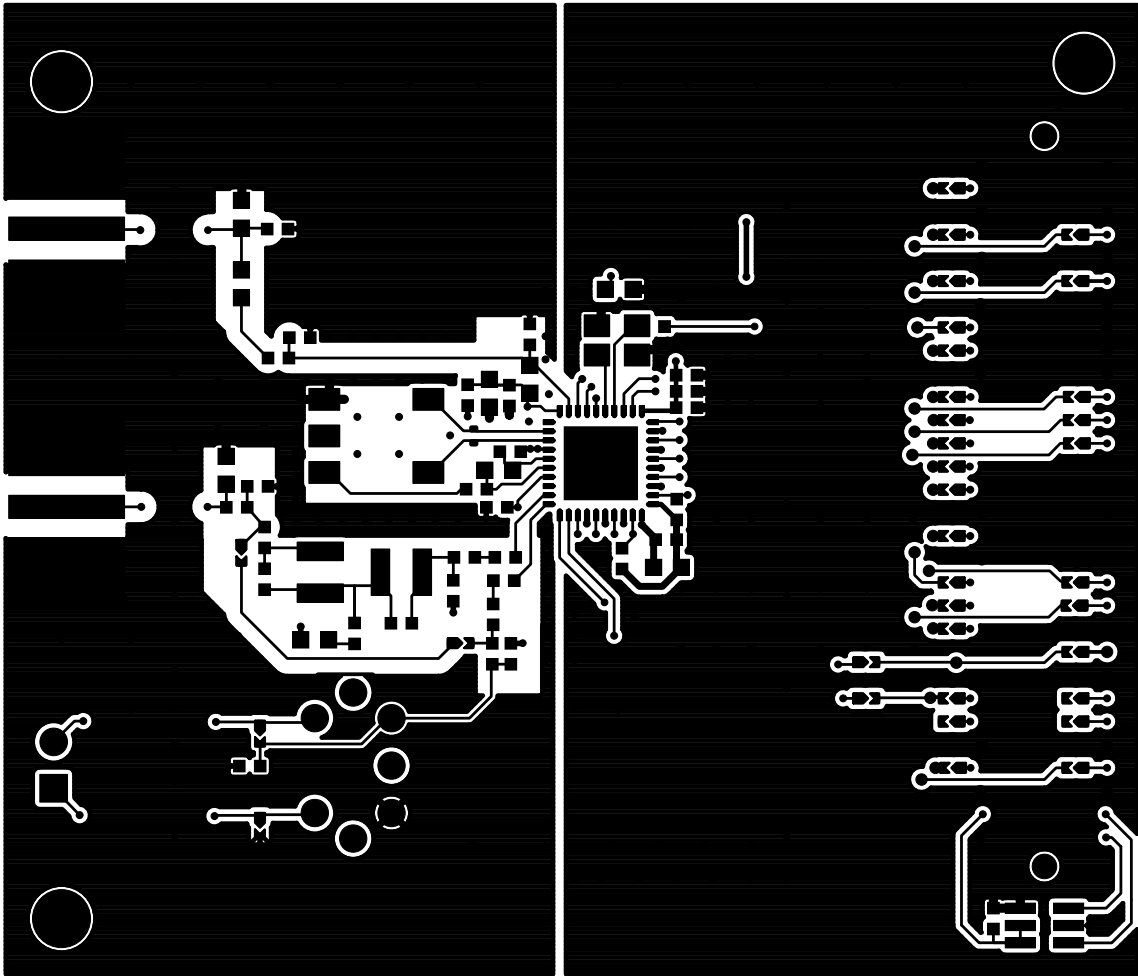

Figure 37. SI477x Daughtercard Rev 2.0 L1 Copper

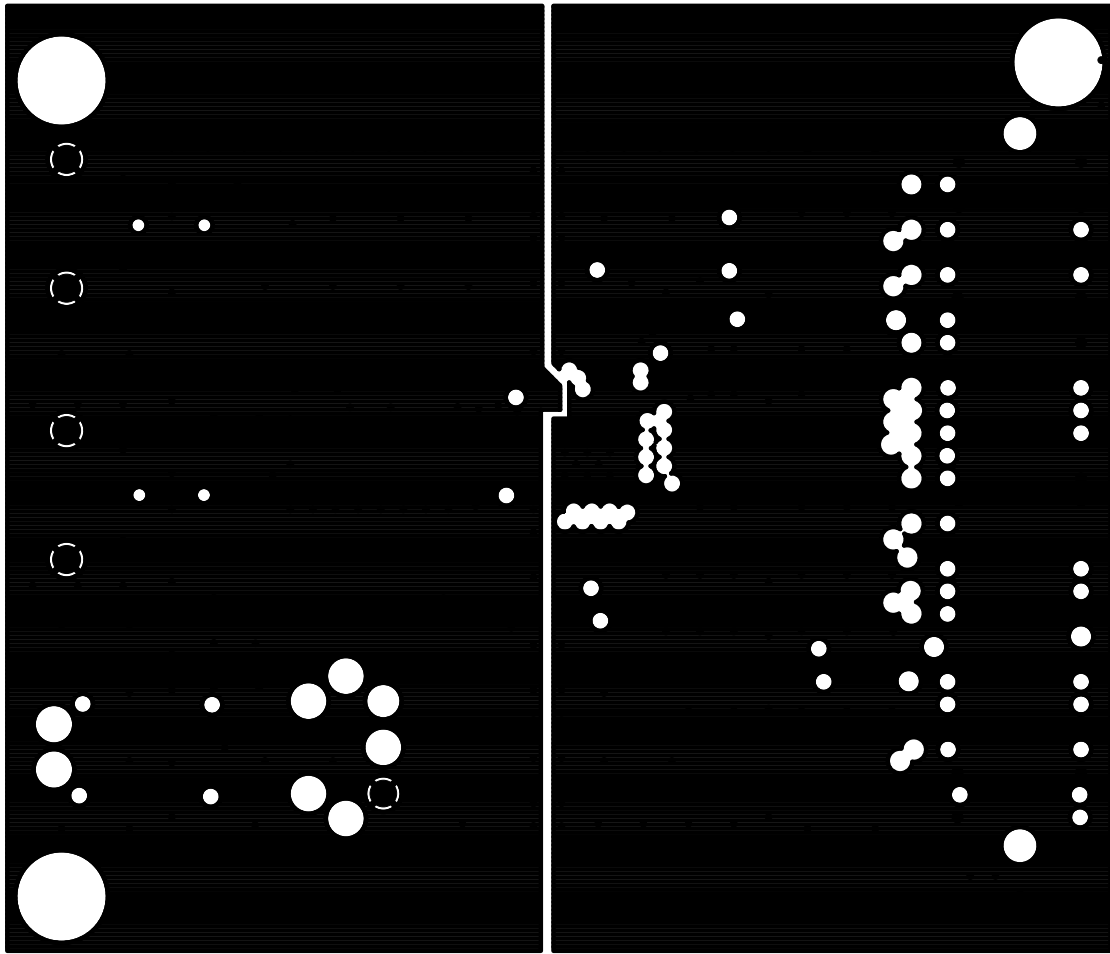

Figure 38. Si477x Daughtercard Rev 2.0 L2 Copper

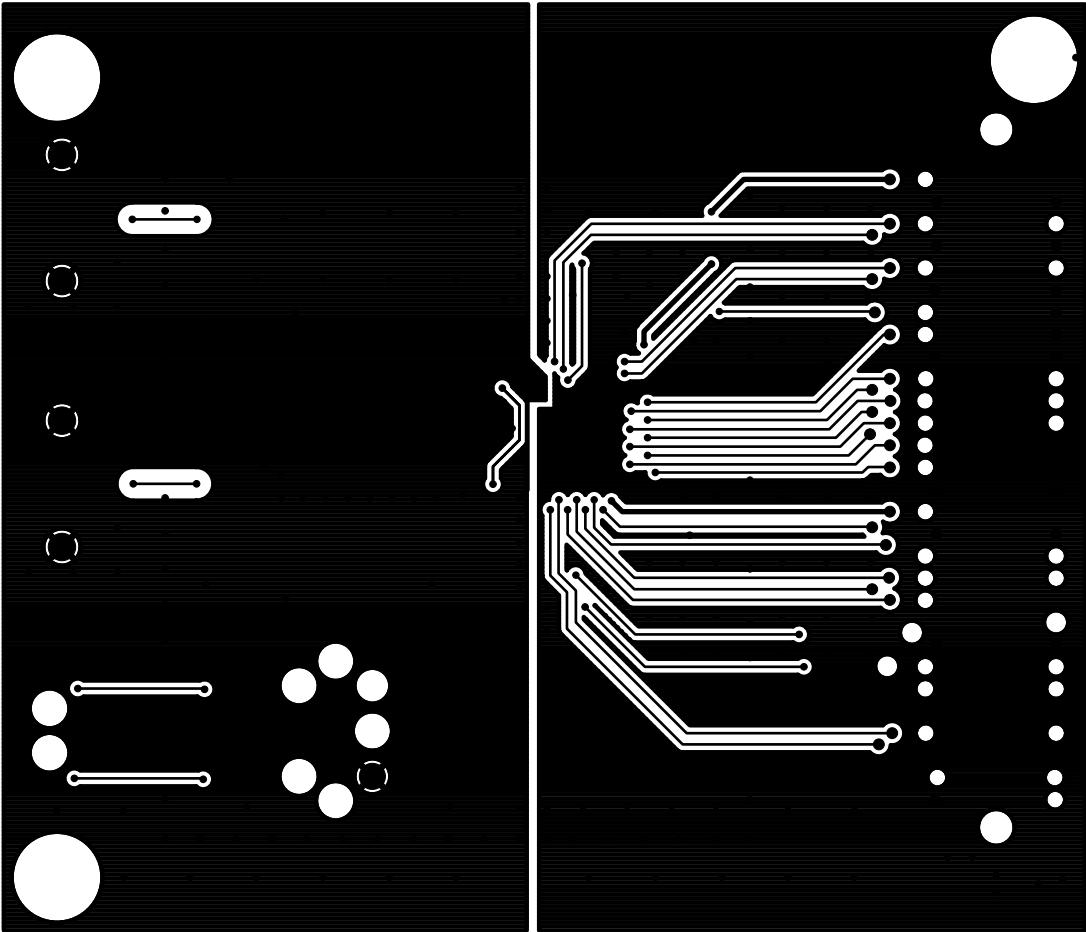

Figure 39. Si477x Daughtercard Rev 2.0 L3 Copper

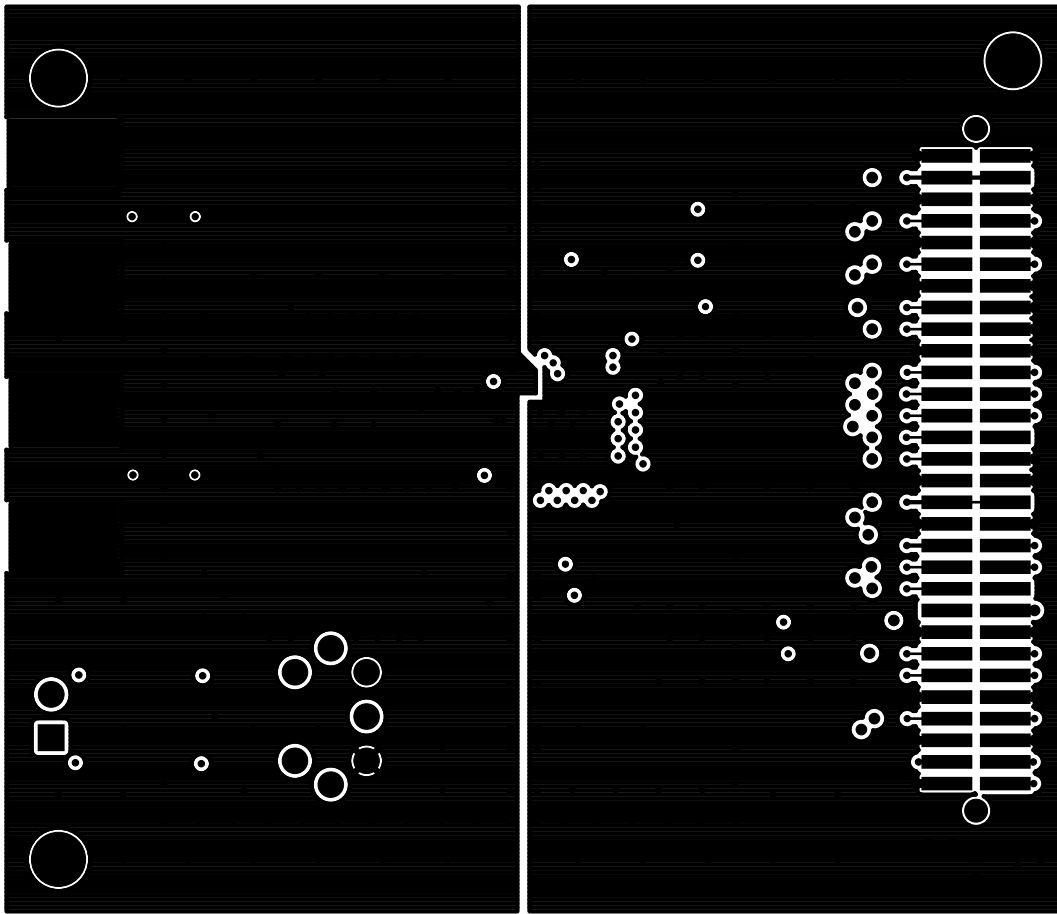

Figure 40. Si477x Daughtercard Rev 2.0 L4 Copper

7.2. Quark Baseboard Rev 1.0

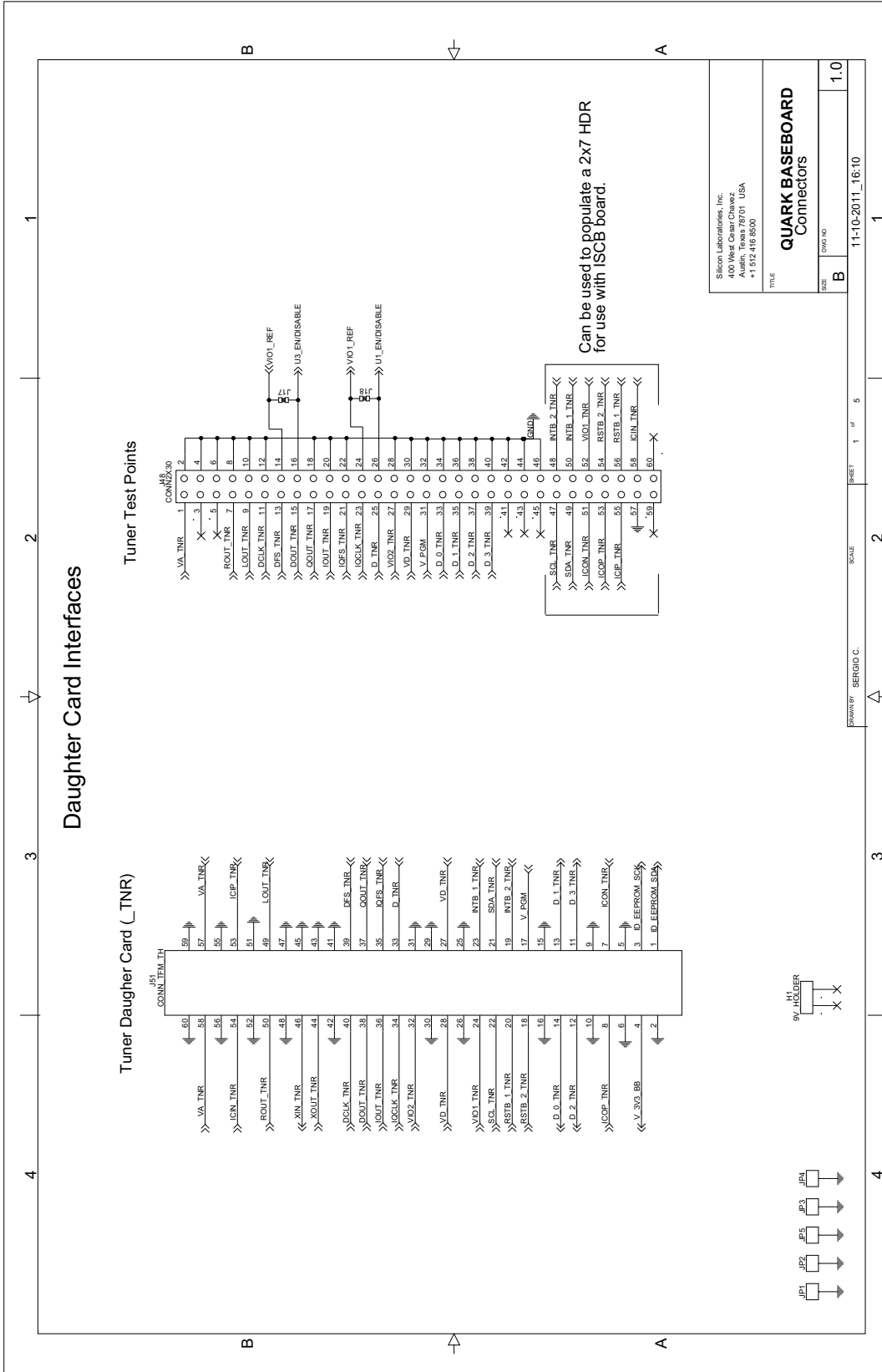

Figure 41. Quark Baseboard Schematic: Connectors

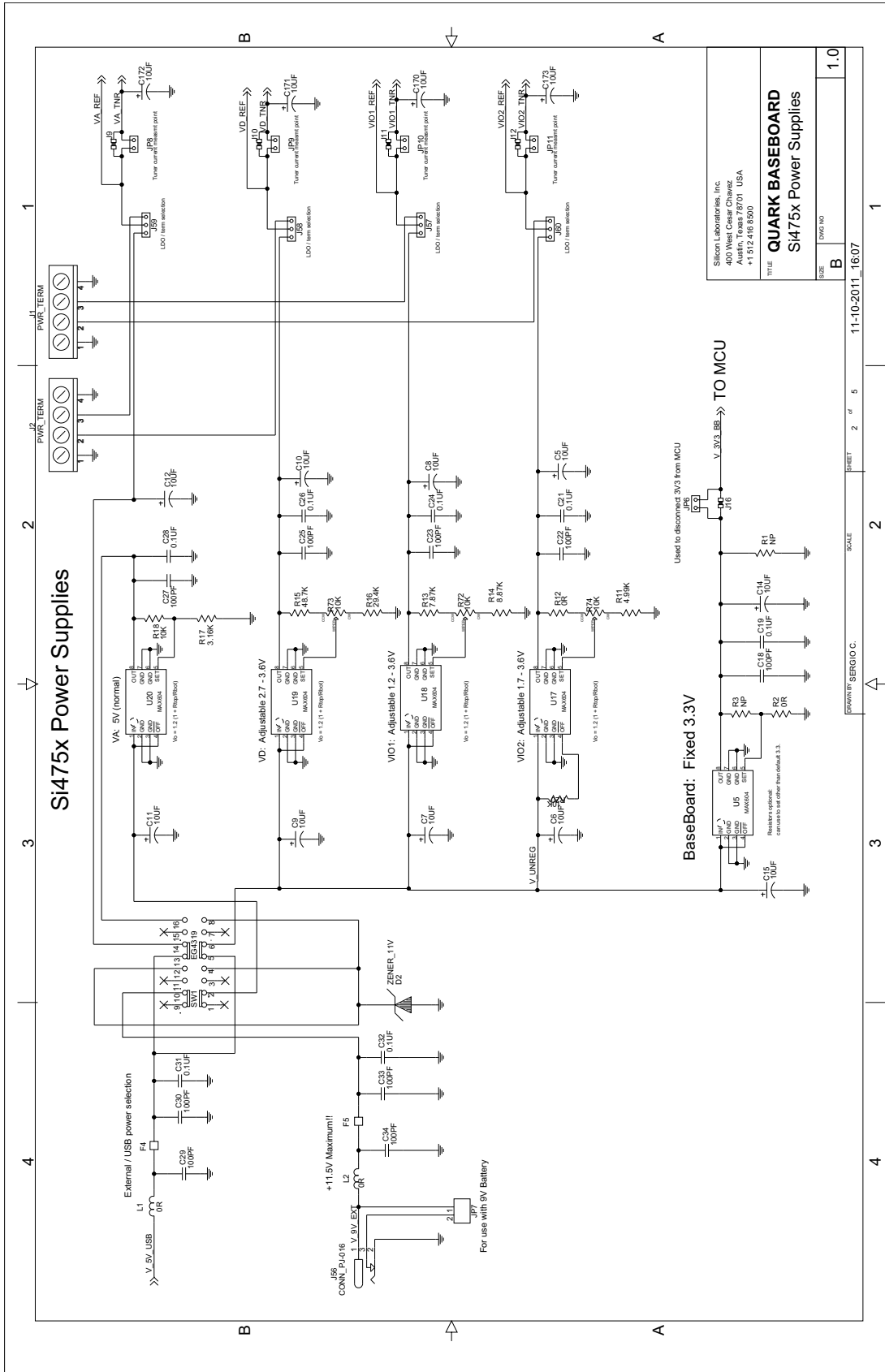

Figure 42. Quark Baseboard Schematic: Power Supplies

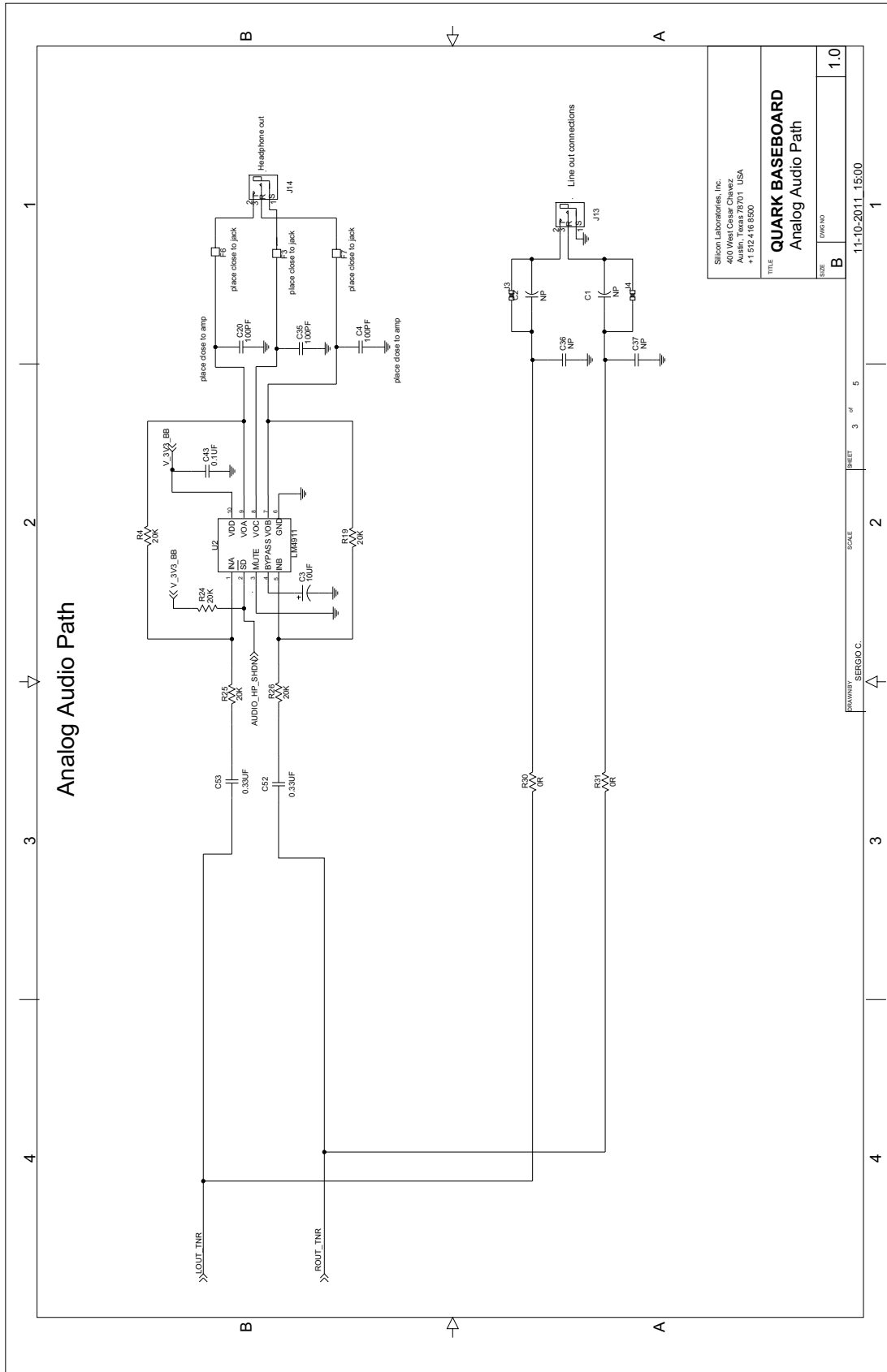

Figure 43. Quark Baseboard Schematic: Analog Audio Path

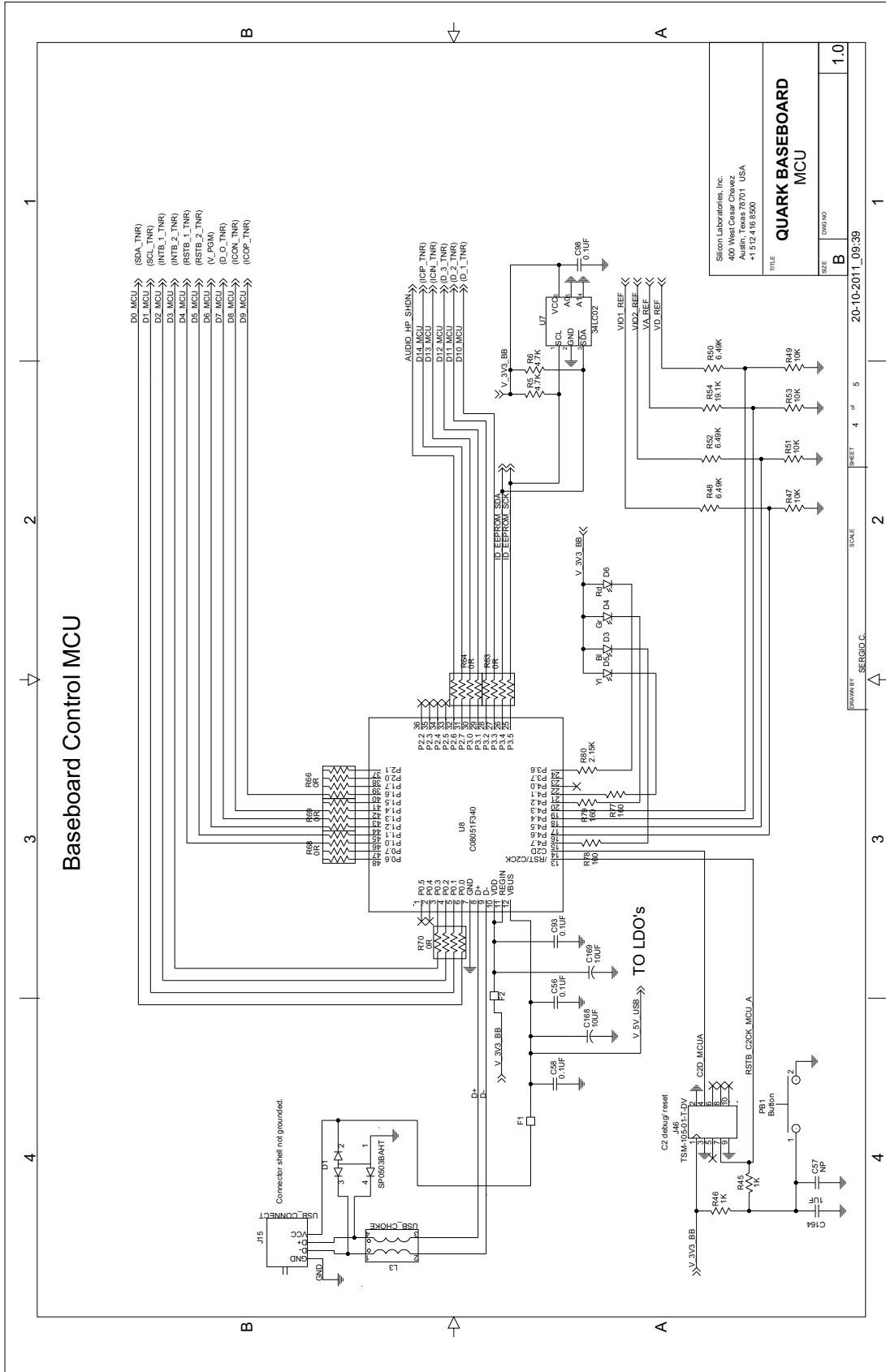

Figure 44. Quark Baseboard Schematic: MCU

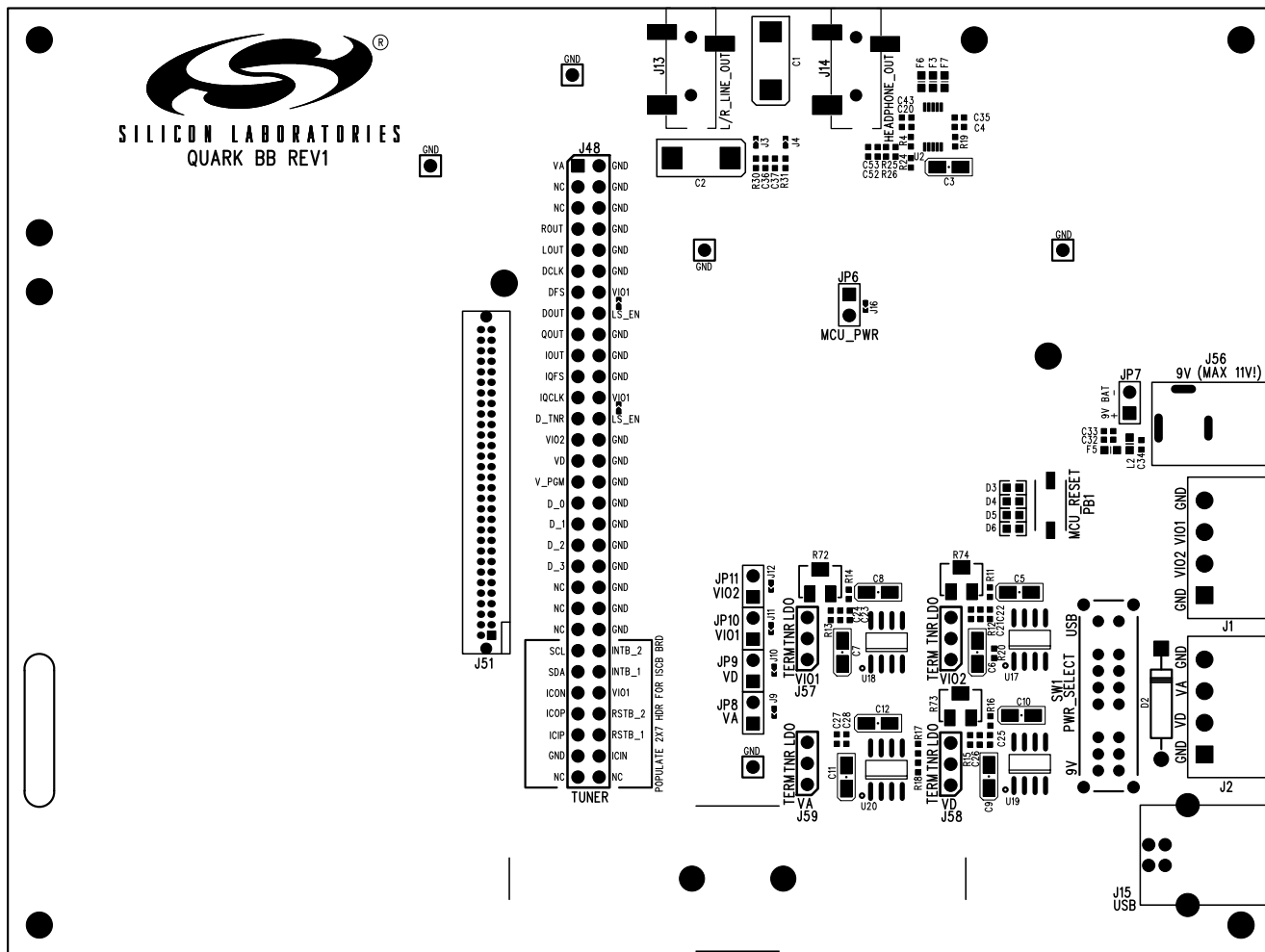

Figure 46. Quark Baseboard Top Silkscreen

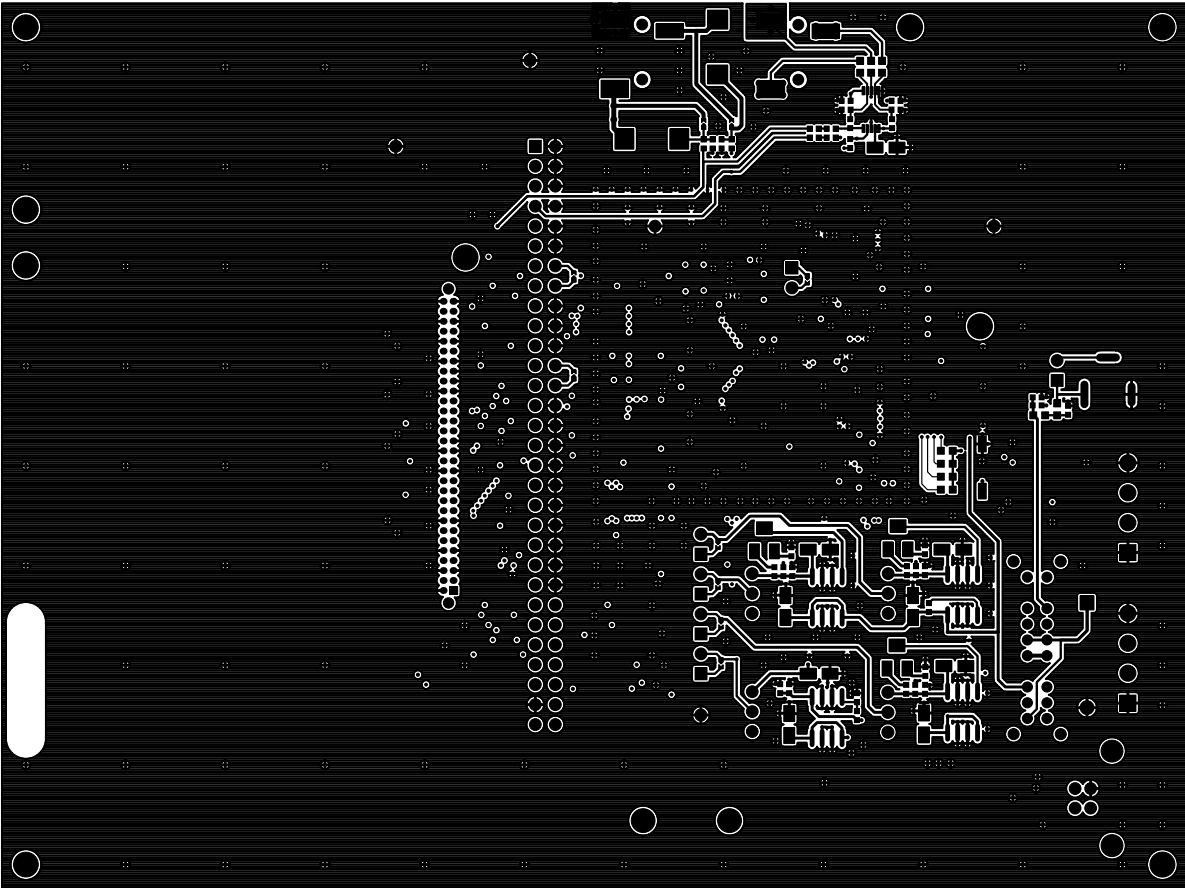

Figure 47. Quark Baseboard L1 Copper

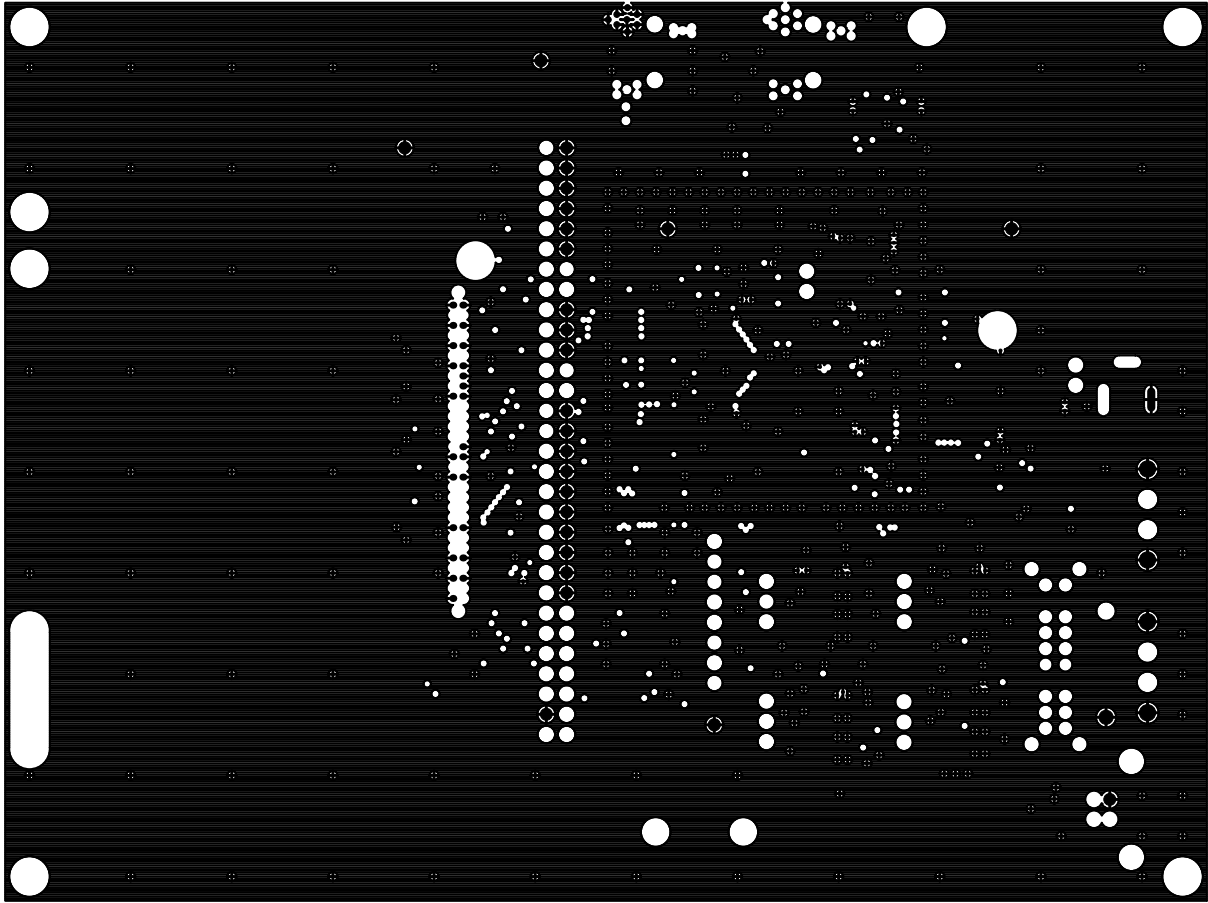

Figure 48. Quark Baseboard L2 Copper

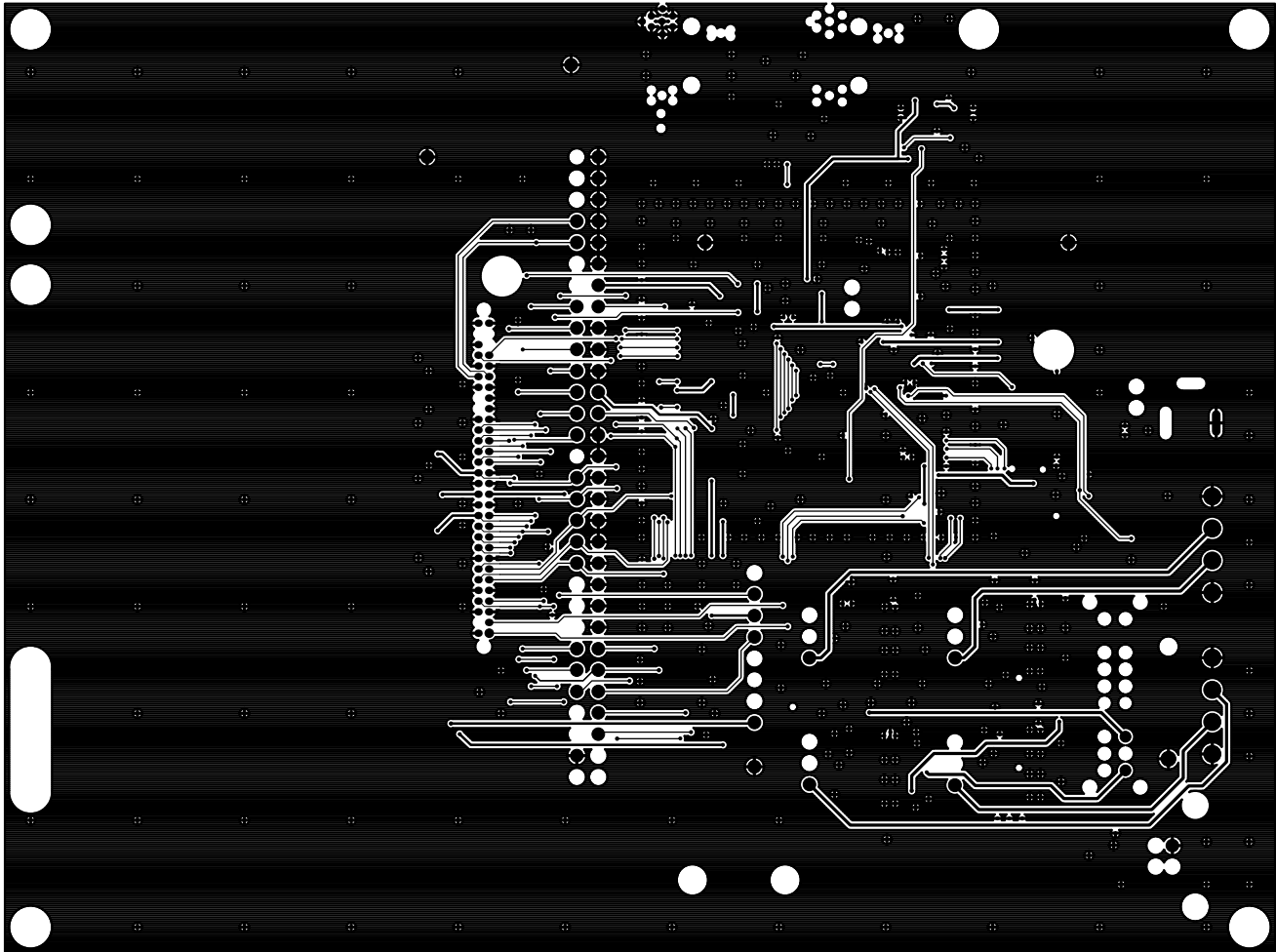

Figure 49. Quark Baseboard L3 Copper

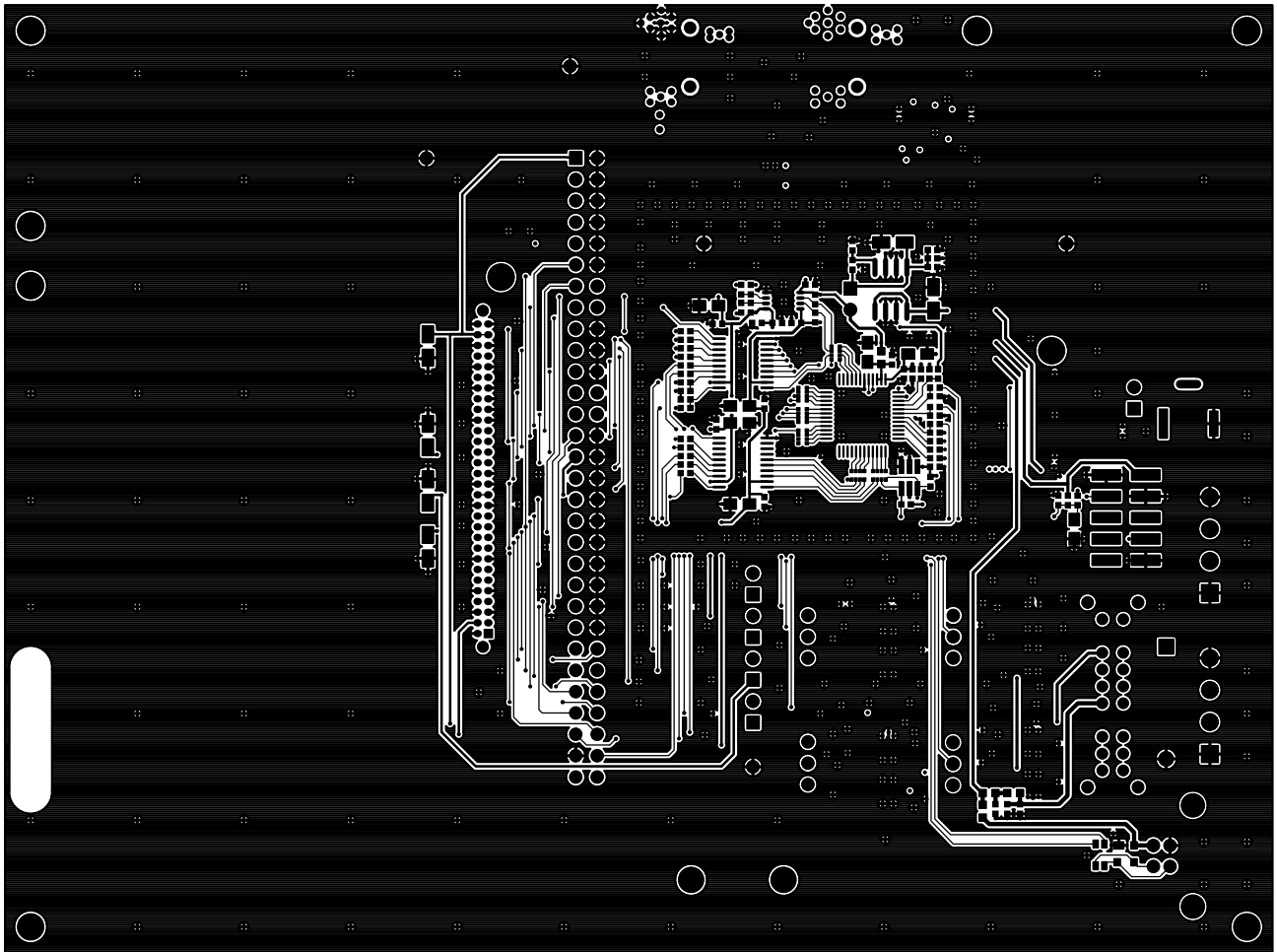

Figure 50. Quark Baseboard L4 Copper

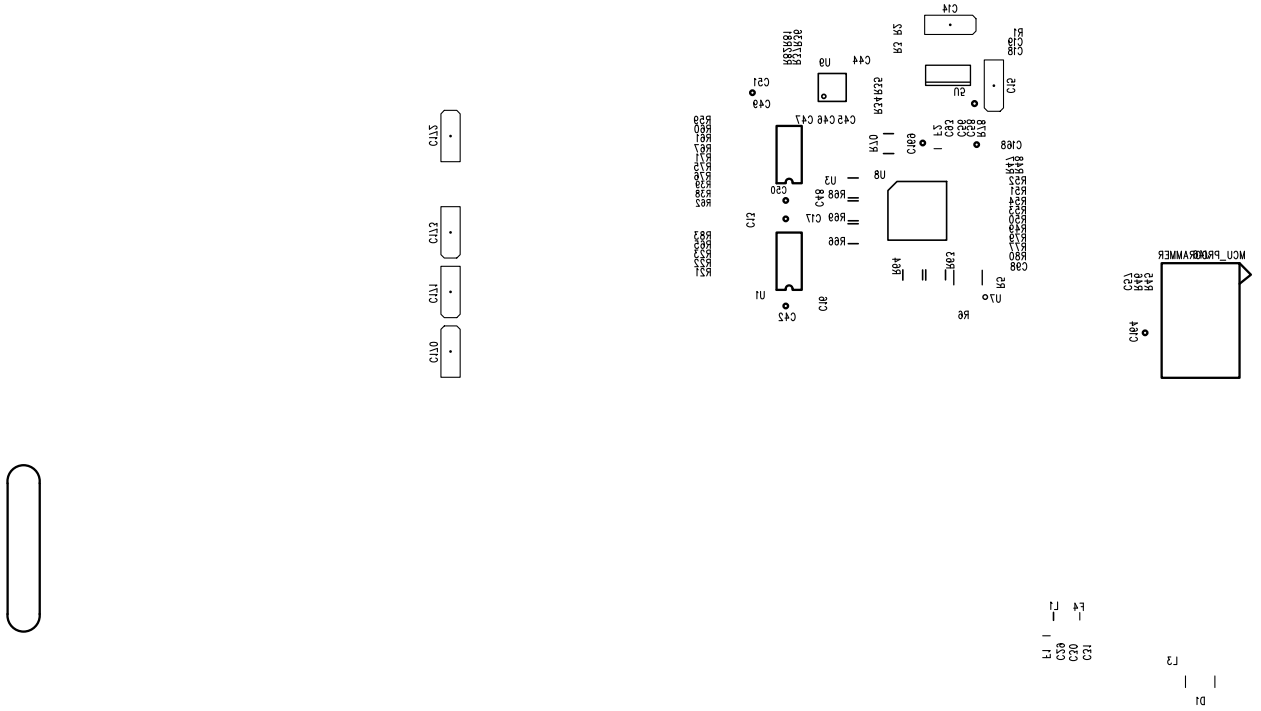
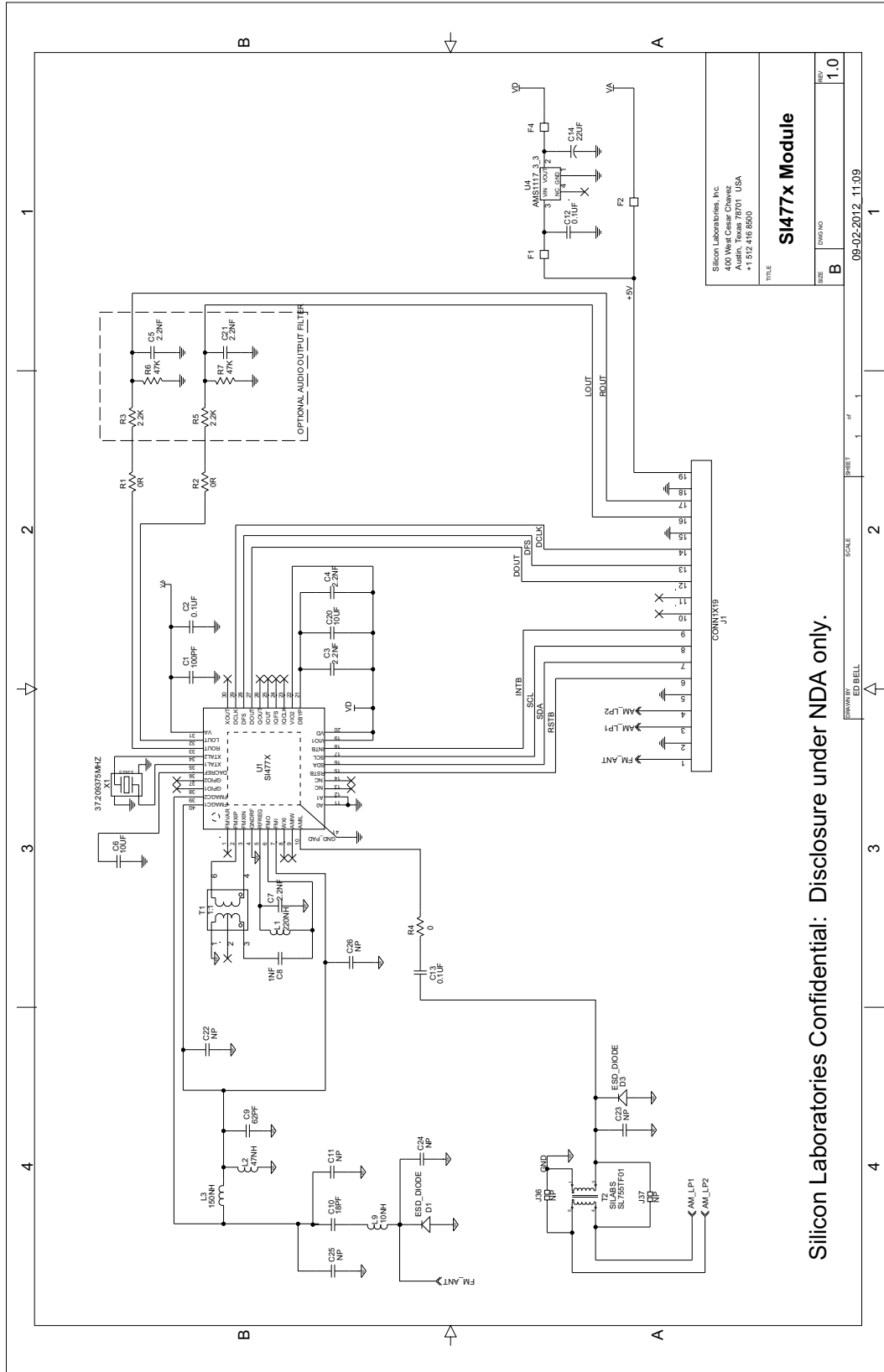

Figure 51. Quark Baseboard Bottom Silkscreen

7.3. Si4770 Module Rev1.0



Silicon Laboratories Confidential: Disclosure under NDA only.

Figure 52. Module Schematic

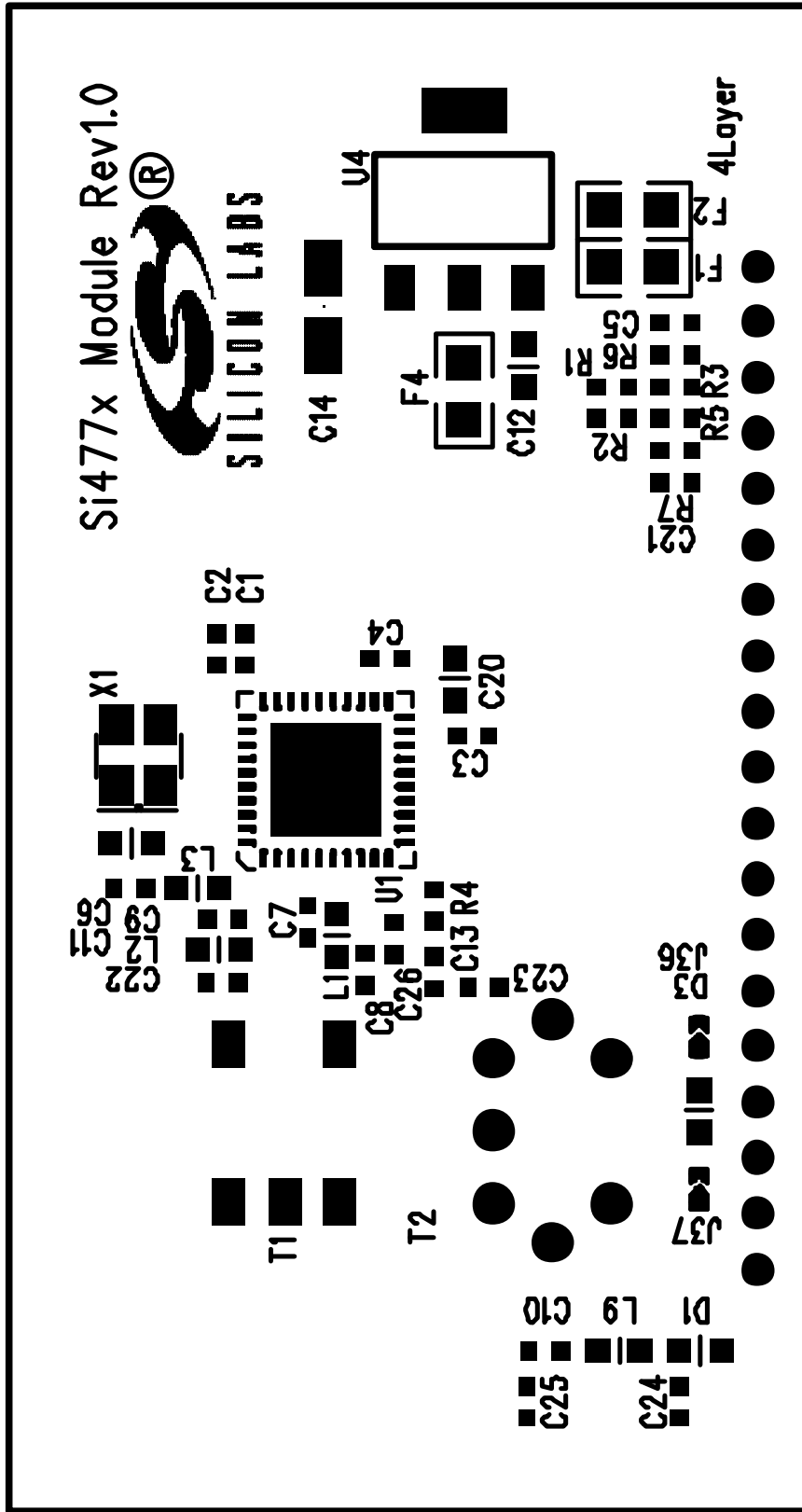

Figure 53. Module Top Silkscreen

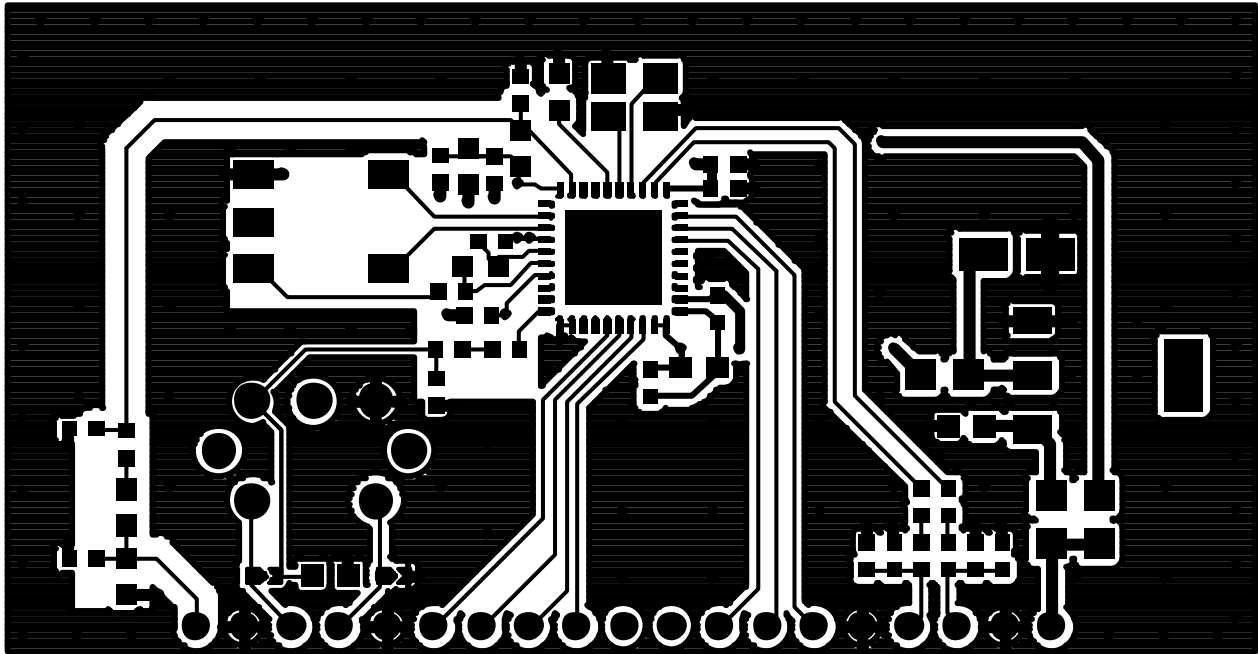

Figure 54. Module L1 Copper

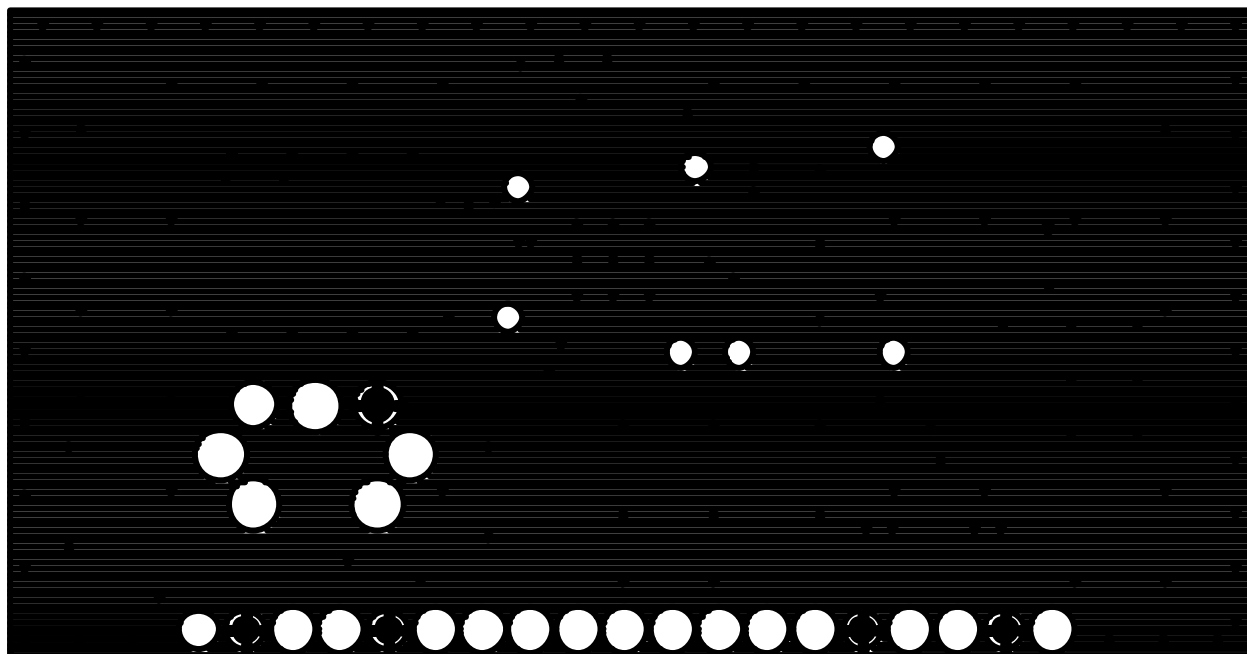

Figure 55. Module L2 Copper

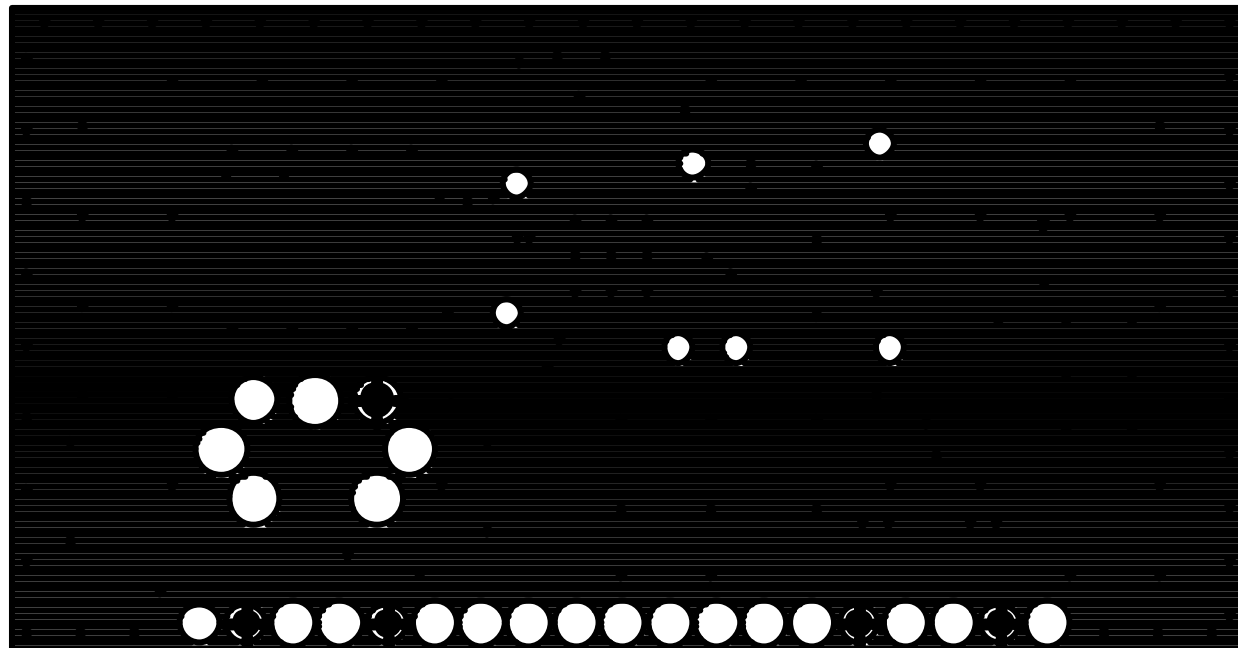

Figure 56. Module L3 Copper

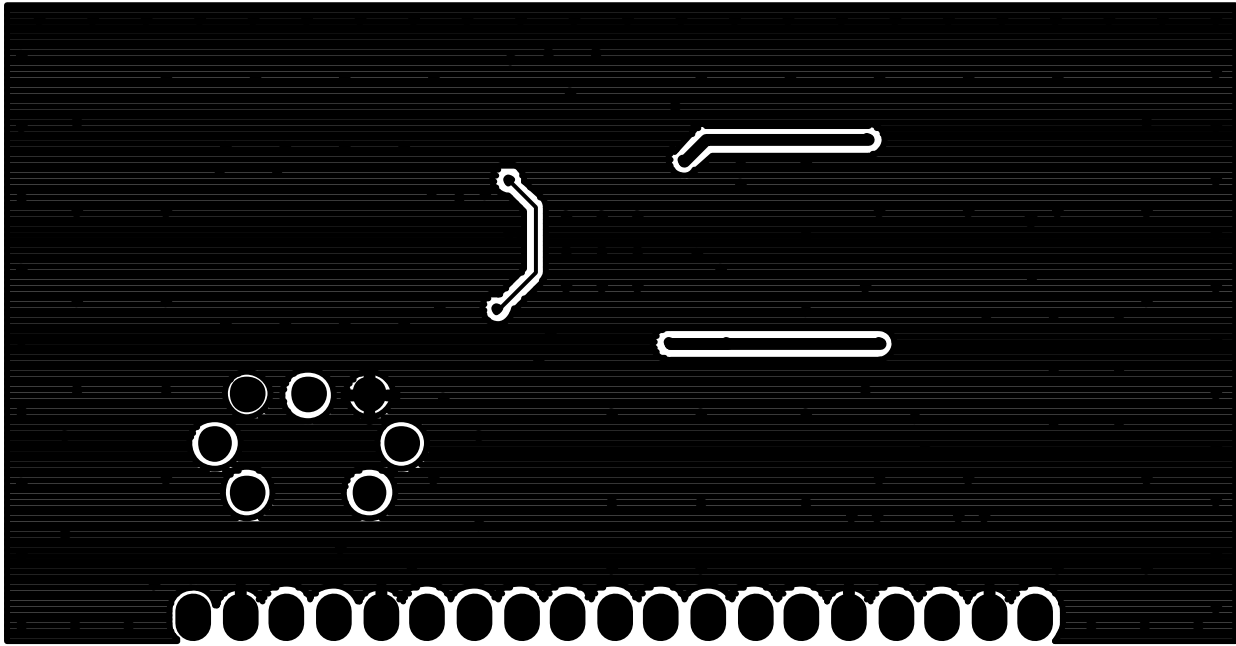

Figure 57. Module L4 Copper

Si477x-EVB

7.4. Si477x Interposer Rev 1.0

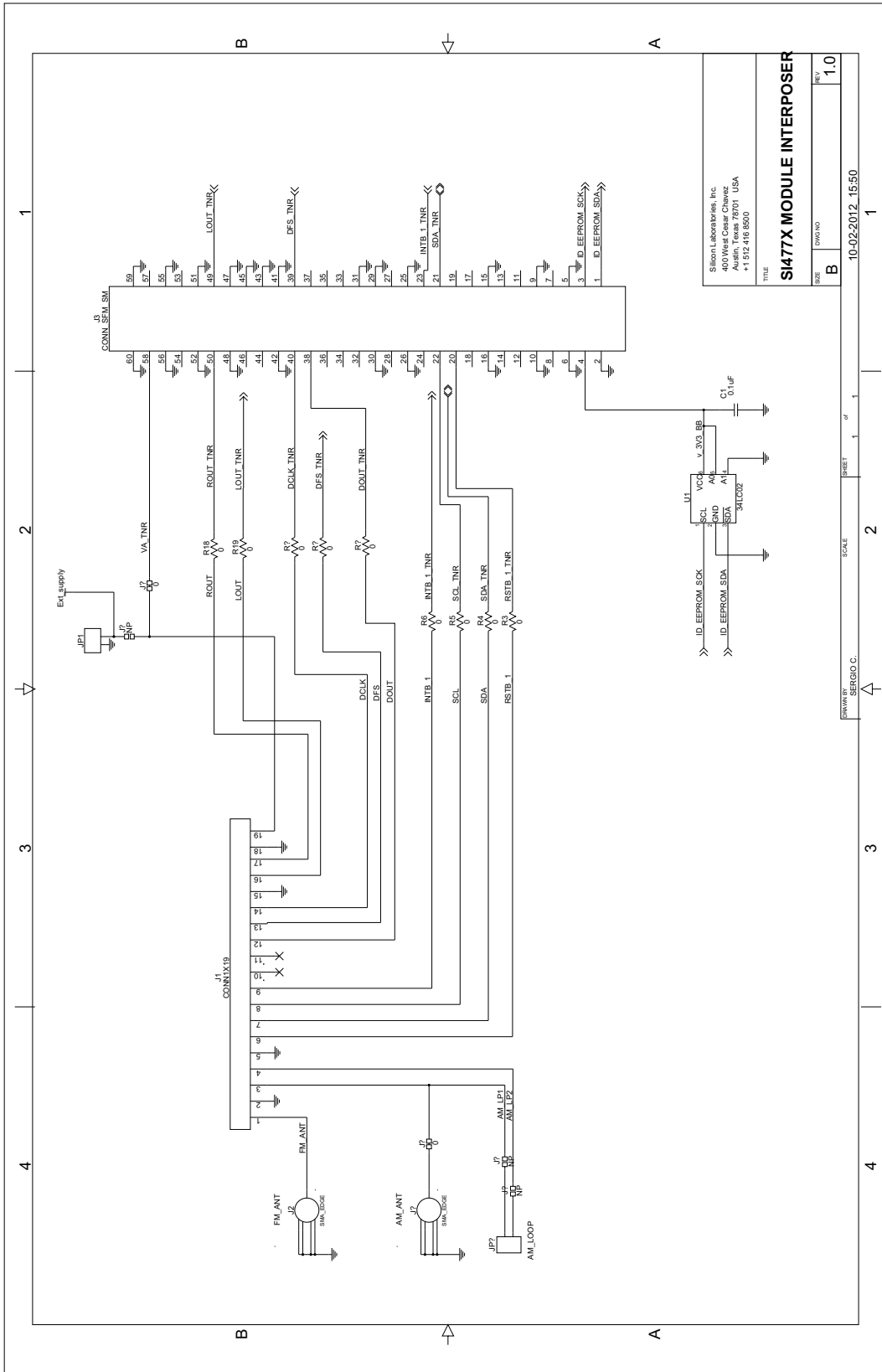

Figure 58. Interposer Schematic

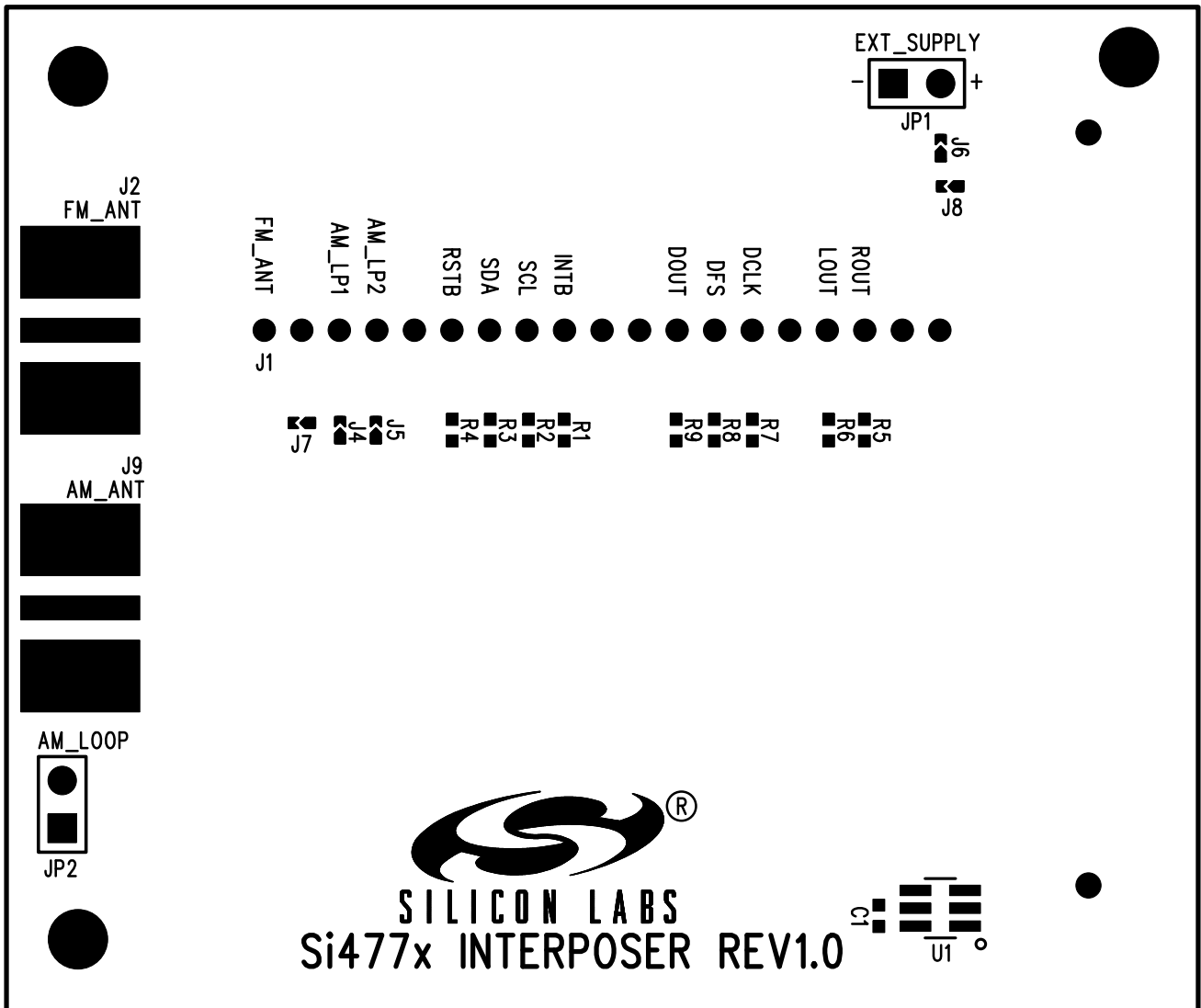

Figure 59. Interposer Top Silkscreen

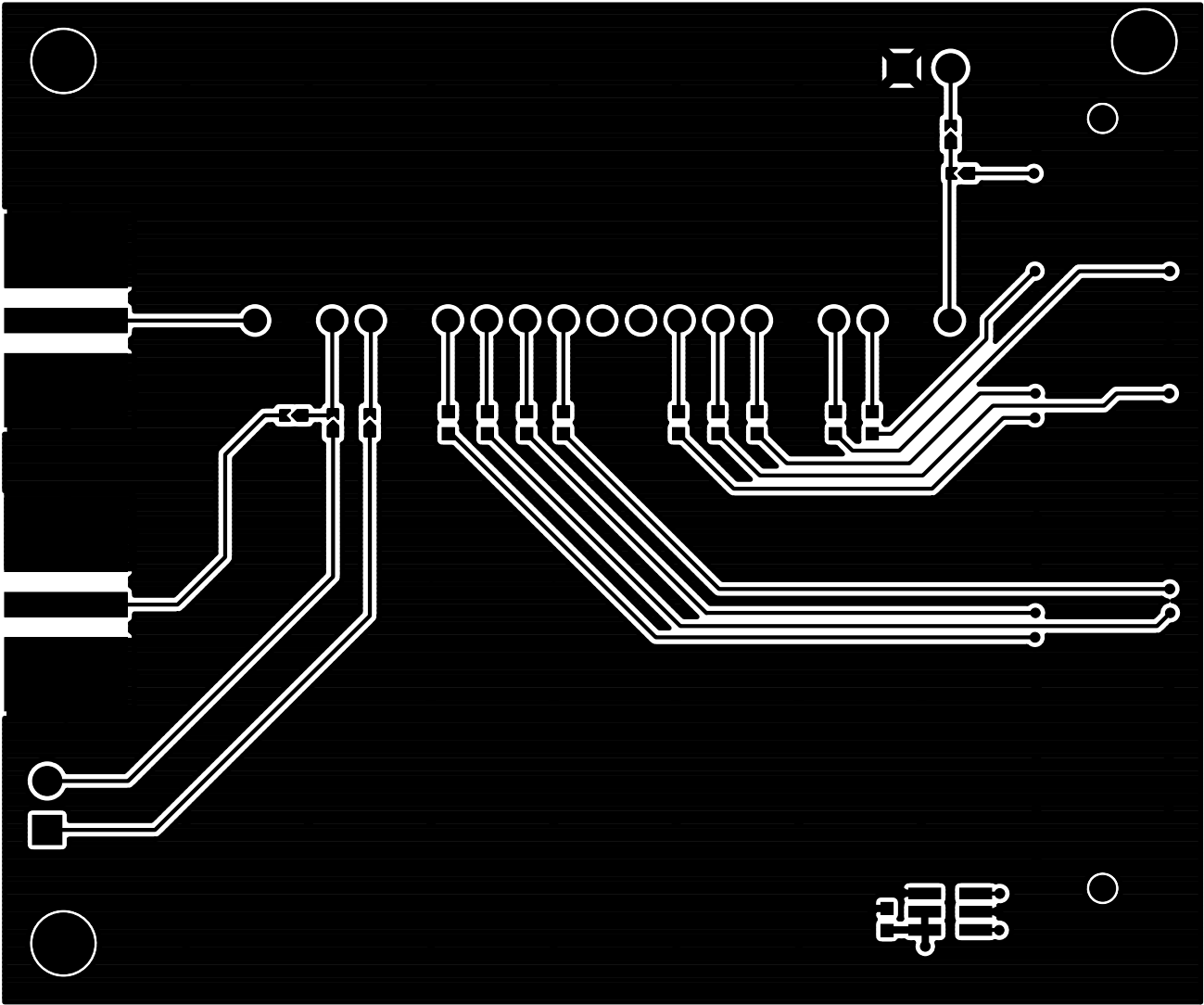

Figure 60. Interposer L1 Copper

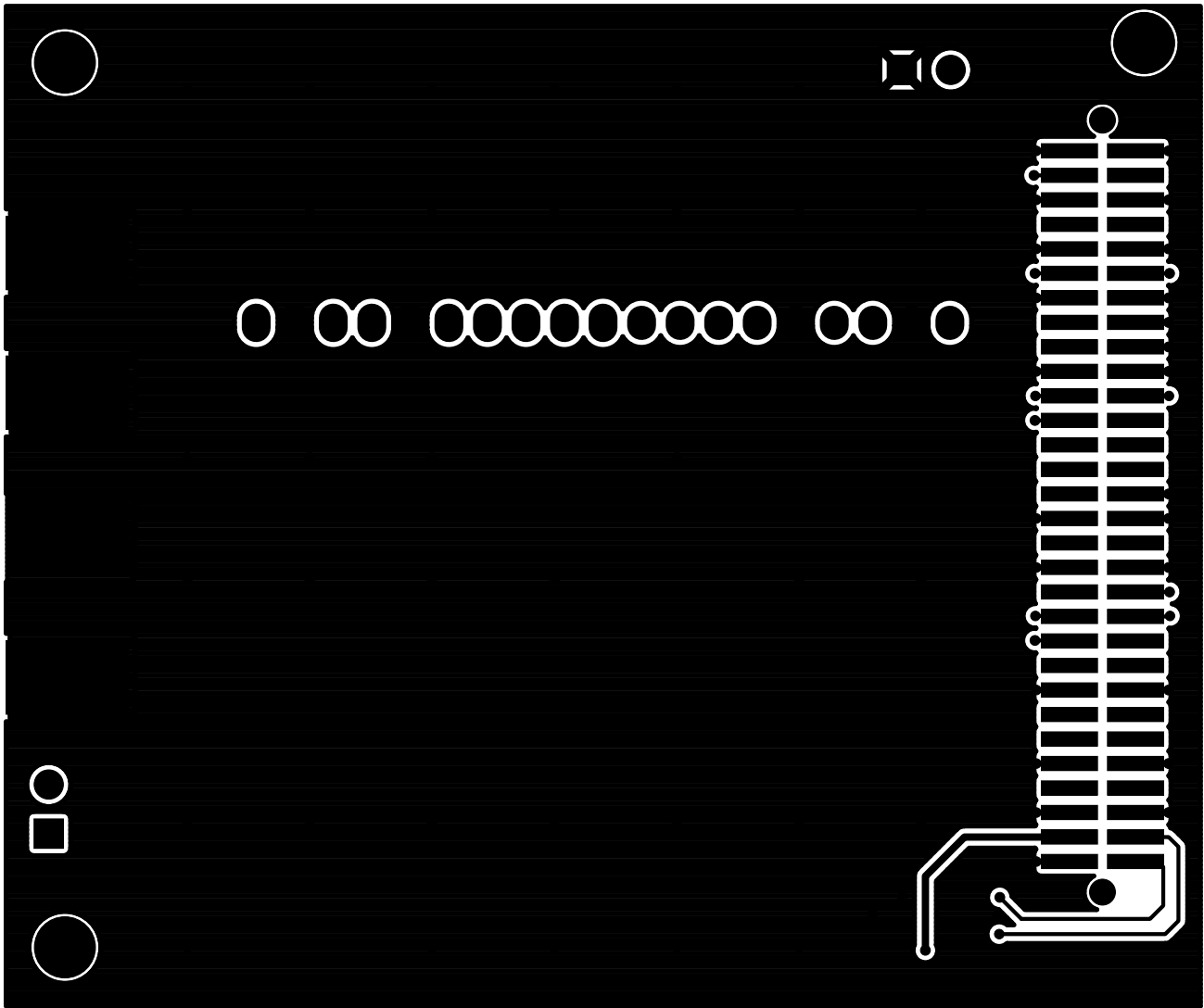

Figure 61. Interposer L2 Copper

Si477x-EVB

DOCUMENT CHANGE LIST:

Revision 0.1 to Revision 0.2

- Converted document to Quark Baseboard.

Revision 0.2 to Revision 0.3

- Added support for the Si4770Module-A-EVB.

Revision 0.3 to Revision 0.4

- Updated BOM

NOTES:

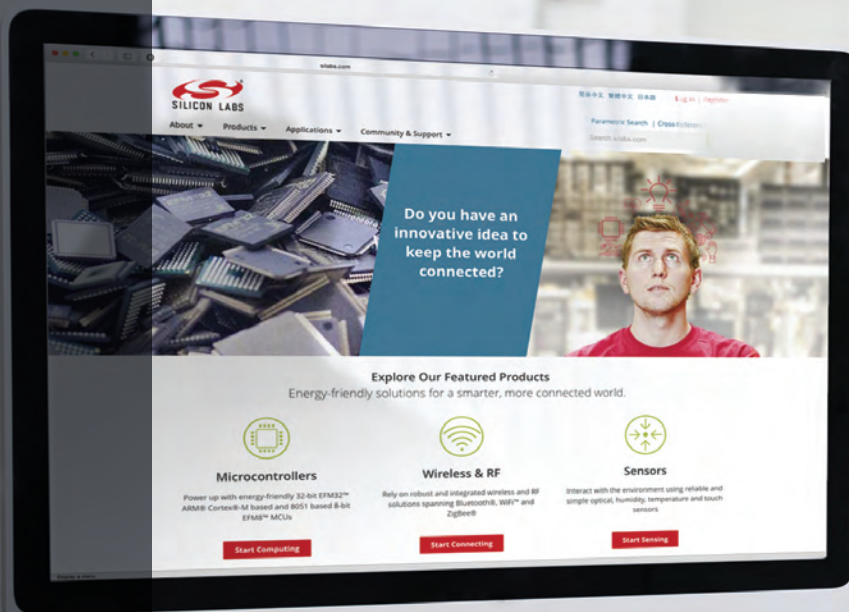

Smart.
Connected.
Energy-Friendly



Products
www.silabs.com/products

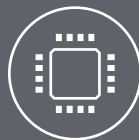

Quality
www.silabs.com/quality



Support and Community
community.silabs.com

Disclaimer

Silicon Laboratories intends to provide customers with the latest, accurate, and in-depth documentation of all peripherals and modules available for system and software implementers using or intending to use the Silicon Laboratories products. Characterization data, available modules and peripherals, memory sizes and memory addresses refer to each specific device, and "Typical" parameters provided can and do vary in different applications. Application examples described herein are for illustrative purposes only. Silicon Laboratories reserves the right to make changes without further notice and limitation to product information, specifications, and descriptions herein, and does not give warranties as to the accuracy or completeness of the included information. Silicon Laboratories shall have no liability for the consequences of use of the information supplied herein. This document does not imply or express copyright licenses granted hereunder to design or fabricate any integrated circuits. The products must not be used within any Life Support System without the specific written consent of Silicon Laboratories. A "Life Support System" is any product or system intended to support or sustain life and/or health, which, if it fails, can be reasonably expected to result in significant personal injury or death. Silicon Laboratories products are generally not intended for military applications. Silicon Laboratories products shall under no circumstances be used in weapons of mass destruction including (but not limited to) nuclear, biological or chemical weapons, or missiles capable of delivering such weapons.

Trademark Information

Silicon Laboratories Inc., Silicon Laboratories, Silicon Labs, SiLabs and the Silicon Labs logo, CMEMS®, EFM, EFM32, EFR, Energy Micro, Energy Micro logo and combinations thereof, "the world's most energy friendly microcontrollers", Ember®, EZLink®, EZMac®, EZRadio®, EZRadioPRO®, DSPLL®, ISOmodem®, Precision32®, ProSLIC®, SiPHY®, USBXpress® and others are trademarks or registered trademarks of Silicon Laboratories Inc. ARM, CORTEX, Cortex-M3 and THUMB are trademarks or registered trademarks of ARM Holdings. Keil is a registered trademark of ARM Limited. All other products or brand names mentioned herein are trademarks of their respective holders.



Silicon Laboratories Inc.
400 West Cesar Chavez
Austin, TX 78701
USA

<http://www.silabs.com>

Looking for pricing, stock, or lifecycle information?

Click below to explore more details on WIN SOURCE:

-  [View SI4770-A-EVB on WIN SOURCE](#)
-  [Skyworks Solutions Inc. Information](#)

Optimize Your Supply Chain with WIN SOURCE Solutions

-  Global Sourcing Solution
-  Obsolete Management
-  Cost Control Management
-  Shortage Management
-  Alternative Solution
-  Excess Inventory Management