

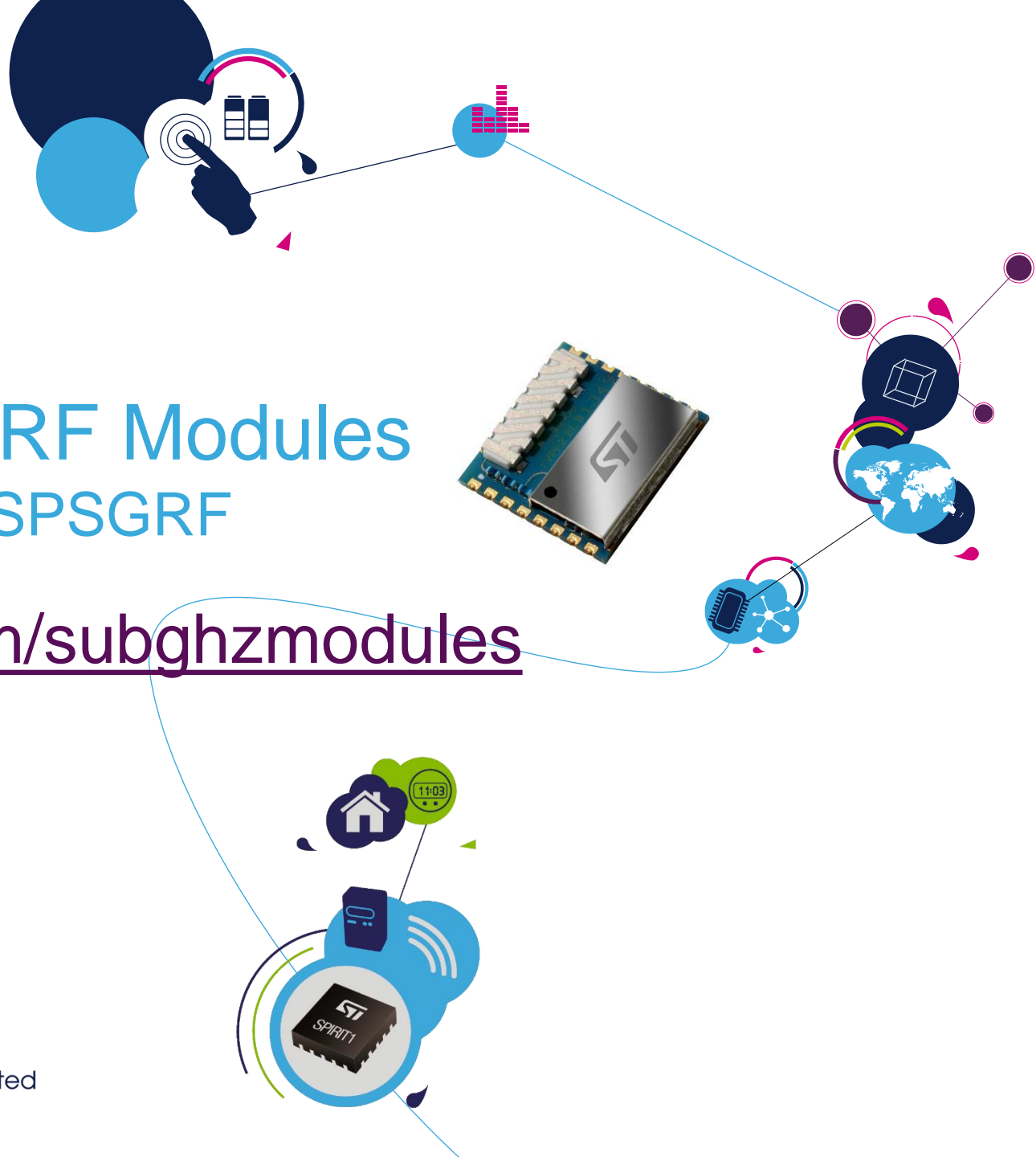

# Sub-GHz RF Modules SP1ML and SPSGRF

[www.st.com/subghzmodules](http://www.st.com/subghzmodules)



# Why an RF Module?

- **Plug & play solution** does not require in-depth RF know-how
- **Certified solution:** FCC or CE (ETSI) certified
- **Flexible solutions** for easier software and hardware integration in an existing system

# Applications for RF Sub-GHz Modules

- Gas / Water smart metering
- Remote control
  - Garage doors
  - Window blinds
  - Industrial remote systems
- Wireless alarm systems
- Heat cost allocators



# ST Sub-GHz RF Modules and evaluation boards



| RF module  | Based on              | Features                      |
|------------|-----------------------|-------------------------------|
| SP1ML-868  | STM32L1+SPIRIT1+Balun | 868 MHz ETSI-certified module |
| SP1ML-915  | STM32L1+SPIRIT1+Balun | 915 MHz FCC-certified module  |
| SPSGRF-868 | SPIRIT1+Balun         | 868 MHz ETSI-certified module |
| SPSGRF-915 | SPIRIT1+Balun         | 915 MHz FCC-certified module  |



| Evaluation board  | Features                                |
|-------------------|---|
| STEVAL-SP1ML-868  | SP1ML-868 USB Dongle (863 to 870 MHz)   |
| STEVAL-SP1ML-915  | SP1ML-915 USB Dongle (902 to 928 MHz)   |
| X-NUCLEO-IDS001A4 | SPSGRF-868 STM32 Nucleo expansion board |
| STEVAL-IDS001V4M  | SPSGRF-868 USB dongle                   |
| X-NUCLEO-IDS001A5 | SPSGRF-915 STM32 Nucleo expansion board |
| STEVAL-IDS001V5M  | SPSGRF-915 USB dongle                   |

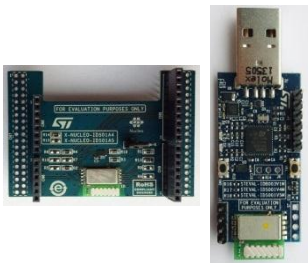

# SP1ML – 868/915 Structure

SP1ML-868 and SP1ML-915 are low-power RF modules based on the SPIRIT1 low-power transceiver and integrate an STM32L151 ultra-low-power MCU

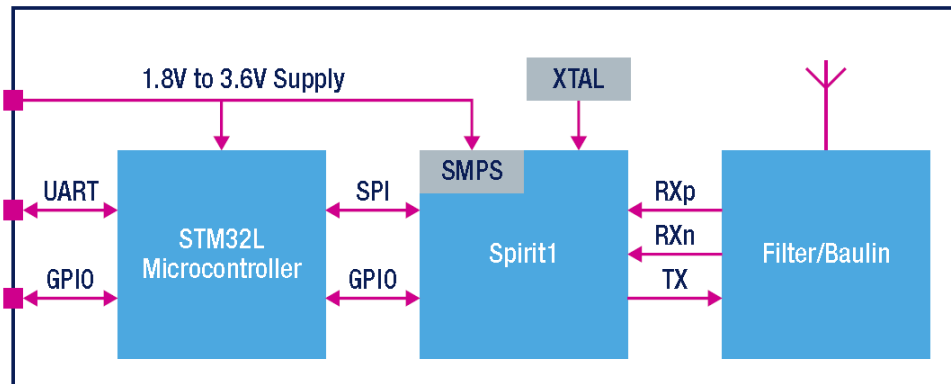
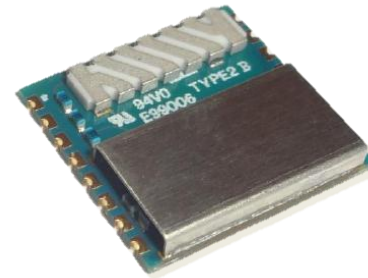
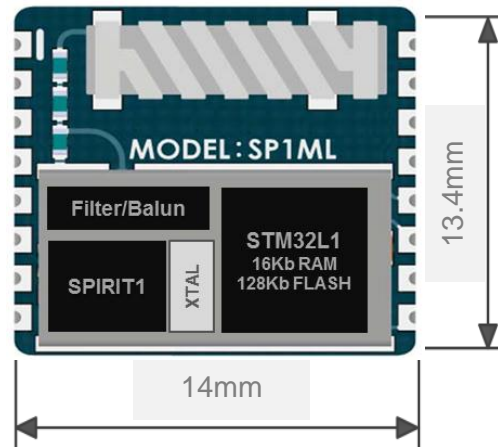

# SP1ML-868/915 Key Features

## SPIRIT1 RF modules for 868 MHz and 915 MHz applications

- Module based on:
  - **SPIRIT1** low-power sub-GHz transceiver
  - **STM32L151RBH6** ultra-low-power ARM Cortex-M3 MCU - 16 Kbytes of RAM – 128 Kbytes of Flash memory
  - **BALF-SPI-01D3** 868/915 MHz IPD balun and filter
- Supports **868 MHz** SRD and **915 MHz** ISM bands
- Surface mount antenna
- 1.8 V to 3.6 V supply - **Low power consumption**
- **Output power** up to +11.6 dBm
- Air data rates up to **500 kbit/s**
- Modulation schemes: 2-FSK, GFSK, MSK, GMSK, OOK, ASK
- Operating temperature: **-40 °C to 85 °C**
- **CE compliant**
- SP1ML-915 is **FCC certified** (FCC ID S9NSP1ML)
- Standard firmware with **AT Command** set interface **via UART** for configuration and cable replacement model

- **AT commands**
- **Network configurations supported**
- **Evaluation tools**

# SP1ML - AT Commands

|            | Command reference                 |
|------------|-----------------------------------|
| ATO        | Enter operating mode              |
| AT/V       | Read module version information   |
| ATIn       | Read an information register      |
| ATSnn?     | Read a configuration register(*)  |
| ATSnn=x    | Write a configuration register(*) |
| AT/S       | Read all configuration registers  |
| AT/C       | Store the current configuration   |
| ATZ        | Restart the module                |
| AT/SRnn?   | Read a SPIRIT1 radio register     |
| AT/SRnn=xx | Write a SPIRIT1 radio register    |
| AT/Tn      | Set RF test mode                  |

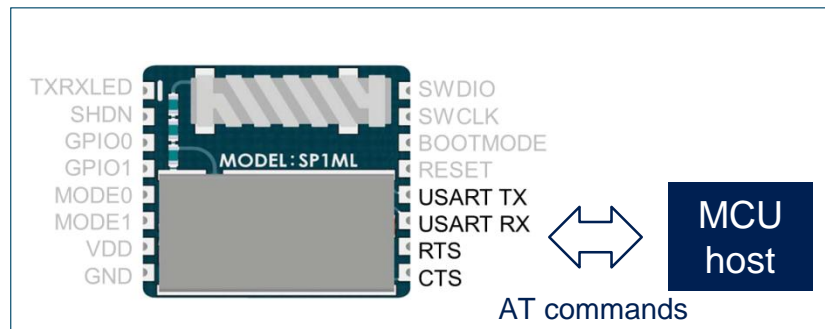
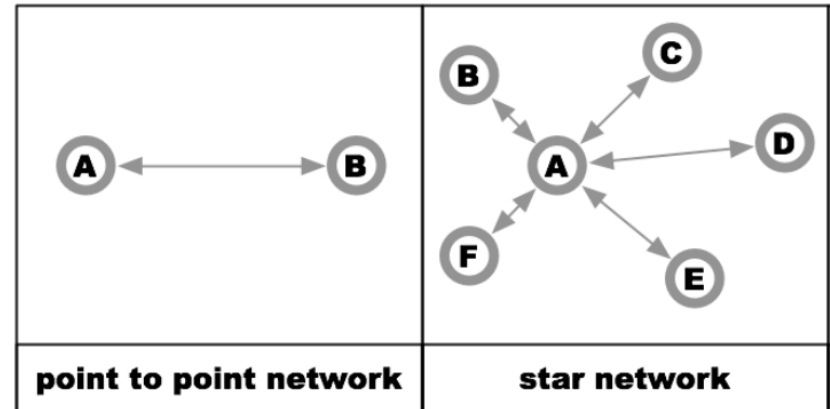

(\*) **Configuration registers**

- S00 BAUD\_RATE
- S01 FREQUENCY
- S02 DATA\_RATE
- S03 MODULATION
- S04 OUTPUT\_POWER
- S05 FREQ\_DEVIATION
- S06 RX\_FILTER
- S07 CS\_MODE
- S08 RSSI\_THRESHOLD
- S09 PREAMBLE\_LEN
- S10 SYNC\_LENGTH
- S11 SYNC\_VALUE
- S12 CRC\_MODE
- S13 WHITENING
- S14 FEC
- S15 SOURCE\_ADDR
- S16 DESTINATION\_ADDR
- S17 MULTICAST\_ADDR
- S18 BROADCAST\_ADDR
- S19 FILTER\_xxx
- TXRX\_LED
- HW\_FLOW\_CTRL
- ESCAPE\_SEQ

# SP1ML – Network Configurations

## Point-to-point

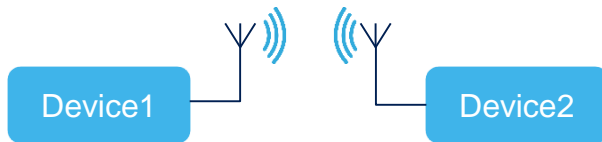

- Same RF and packet configuration for device 1 & 2
- Filtering conditions defined so that device 1 will only receive packet from device 2 (and reciprocally)

## Star network: Point-to-point, multicast or broadcast

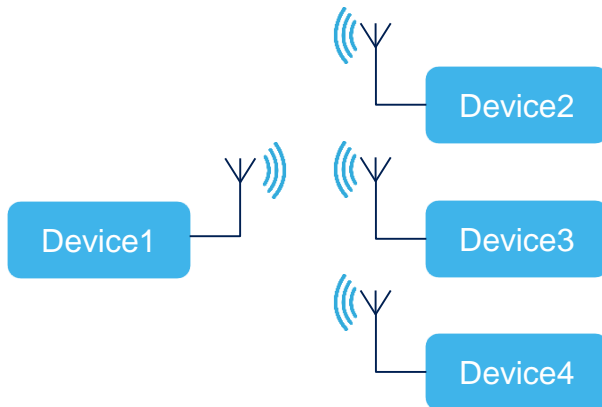

- Same RF and packet configuration for devices 1, 2, 3 and 4
- Filtering conditions for data to be sent
  - Point-to-point: e.g. Device 1 sends data to Device 2 only
  - Multicast: e.g. Device 1 sends data to Device 2 and 3 only
  - Broadcast: e.g. Device 1 sends data to Devices 2, 3 and 4

# SP1ML – Evaluation Tools

## STEVAL-SP1ML868 and STEVAL-SP1ML915 USB dongles

- STEVAL-SP1ML868 and 915 demonstration board allows to evaluate SP1ML-868 and 915 modules in a quick and simple way.

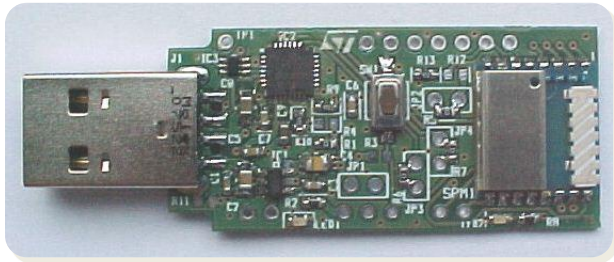

```
COM4:115200baud - Tera Term V1
File Edit Setup Control Window KanjiCode Help
+++OK
00:BAUD_RATE=115200
01:FREQUENCY=868000000
02:DATA_RATE=80000
03:MODULATION=0
04:OUTPUT_POWER=11.6
05:FREQ_DEVIATION=40
06:RX_FILTER=100
07:CS_MODE=0
08:RSSI_THRESHOLD=-130
09:PREAMBLE_LEN=6
10:SYNC_LENGTH=4
11:SYNC_VALUE=0x88888888
12:CRC_MODE=2
13:WHITENING=1
14:FEC=0
15:SOURCE_ADDR=0x00
16:DESTINATION_ADDR=0x01
17:MULTICAST_ADDR=0x00
18:BROADCAST_ADDR=0xff
19:FILTER_CRC=0
20:FILTER_SOURCE=0
21:FILTER_DESTINATION=0
22:FILTER_MULTICAST=0
23:FILTER_BROADCAST=0
24:TX_RX_LED=1
25:HW_FLOW_CTRL=1
26:ESCAPE_SEQ=1
27:SOURCE_FILTER_MASK=0x00
28:PAYLOAD_SIZE=32
```

- USB connector is used to connect the dongle with a PC, to access the sub-GHz RF module and to supply the dongle
- User manual UM1889 - SP1ML modules getting started guide with firmware upgrade and simple communication setup

# SPSGRF Structure

SPSGRF-868 and SPSGRF-915 are low-power RF modules based on the SPIRIT1 low-power transceiver

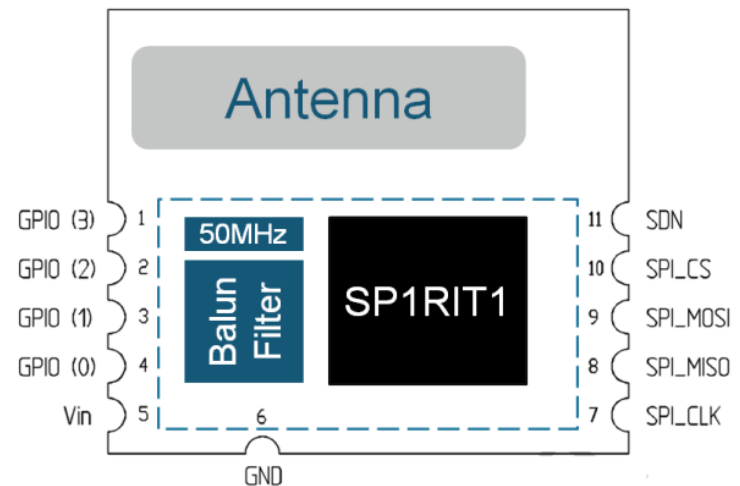
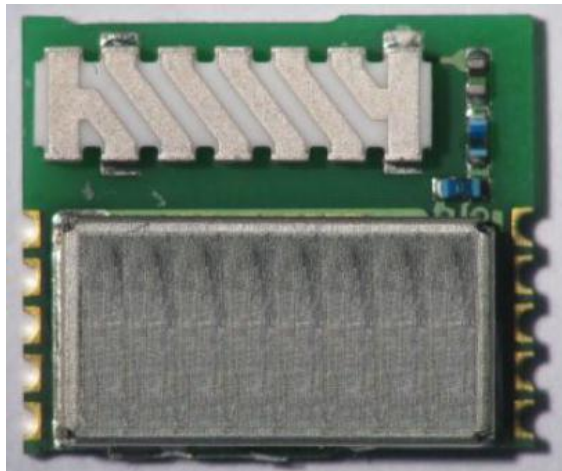

# SPSGRF Key Features

## SPSGRF-868 and SPSSGRF-915 low-power programmable RF transceiver modules for 868 MHz and 915 MHz applications

- Module based on:
  - **SPRIT1** low-power sub-GHz transceiver
  - **BALF-SPI-01D3** balun and filter
  - Surface mount antenna
- Tiny size: **13.5 x 11.5 mm**
- 500 Kbits/s data rate
- Temp. range from  $-40$  to  $85$  °C
- Receiver sensitivity: **-118 dBm**
- Output power up to **+11.6 dBm**
- **RX: 9 mA, Tx: 21 mA @ +11 dBm**
- **Shutdown: 2.5 nA**
- **SPI** host interface
- **CE compliant**
- SPSSGRF-915 is an **FCC certified** module (FCC ID: S9NSPSSGRF)

- **STM32 Nucleo expansion board**
  
- **USB dongle**

# STM32 Nucleo expansion board

Sub-GHz expansion board  
based on SPIRIT1 SPSGRF module

- Expansion board for STM32 Nucleo development boards
- Scalable solution, can cascade multiple boards for larger systems
- Equipped with Arduino UNO R3 connectors
- RoHS compliant
- X-CUBE-SUBG1 example firmware:
- Point-to-point simple communication demo
- WMBus standalone application for automatic meter reading system



**X-NUCLEO-IDS01A4** based on SPSGRF-868  
(868 MHz ETSI-certified module)

**X-NUCLEO-IDS01A5** based on SPSGRF-915  
(915 MHz FCC-certified module)

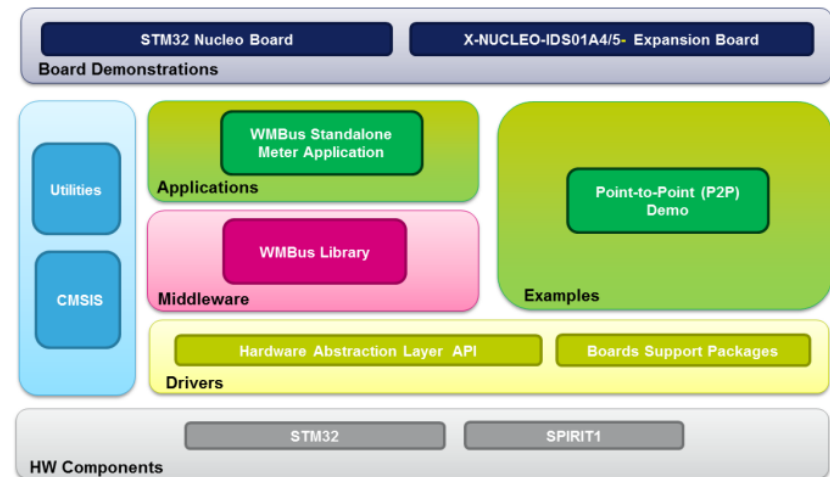

# Sub-GHz RF USB Dongle

- USB dongle with on-board SPSGRF
  - Modulation: 2-FSK, GFSK, MSK, GMSK, OOK and ASK
  - Air data rate: from 1 to 500 kbits/s
- Full compliance in terms of firmware and GUI with the SPIRIT1 development kits: STSW-CONNECT009
- On-board:
  - STM23L low-power MCU
  - Debug connector
  - USB interface
- RoHS compliant

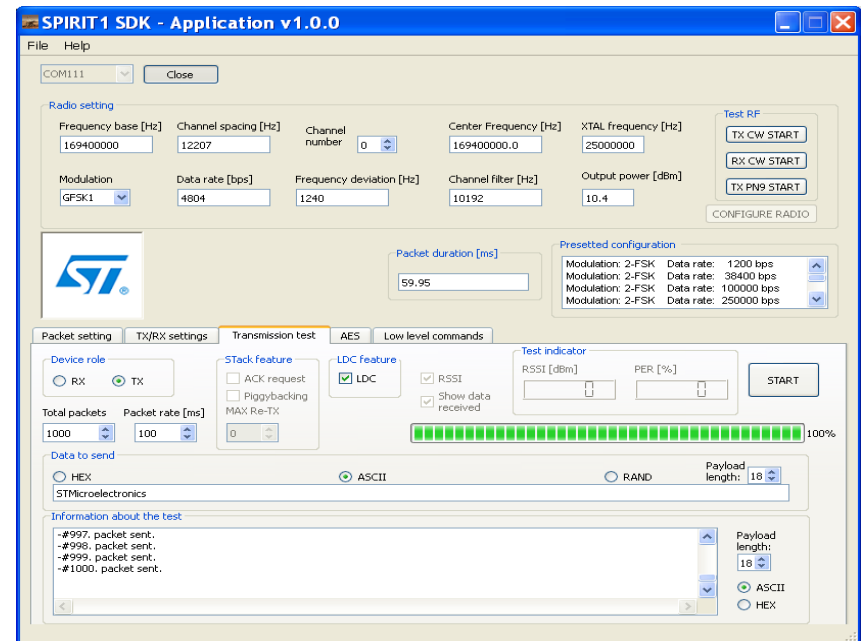
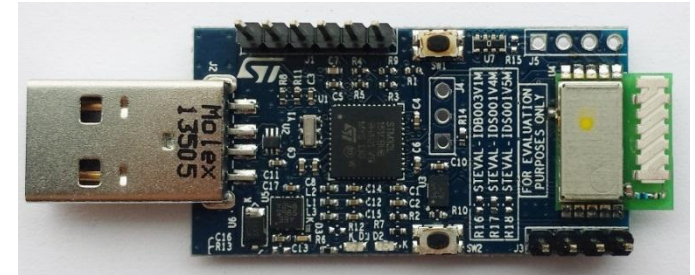

**STEVAL-IDS001V4M** based on SPSGRF-868  
(868 MHz ETSI-certified module)

**STEVAL-IDS001V5M** based on SPSGRF-915  
(915 MHz FCC-certified module)

# Thank You

16

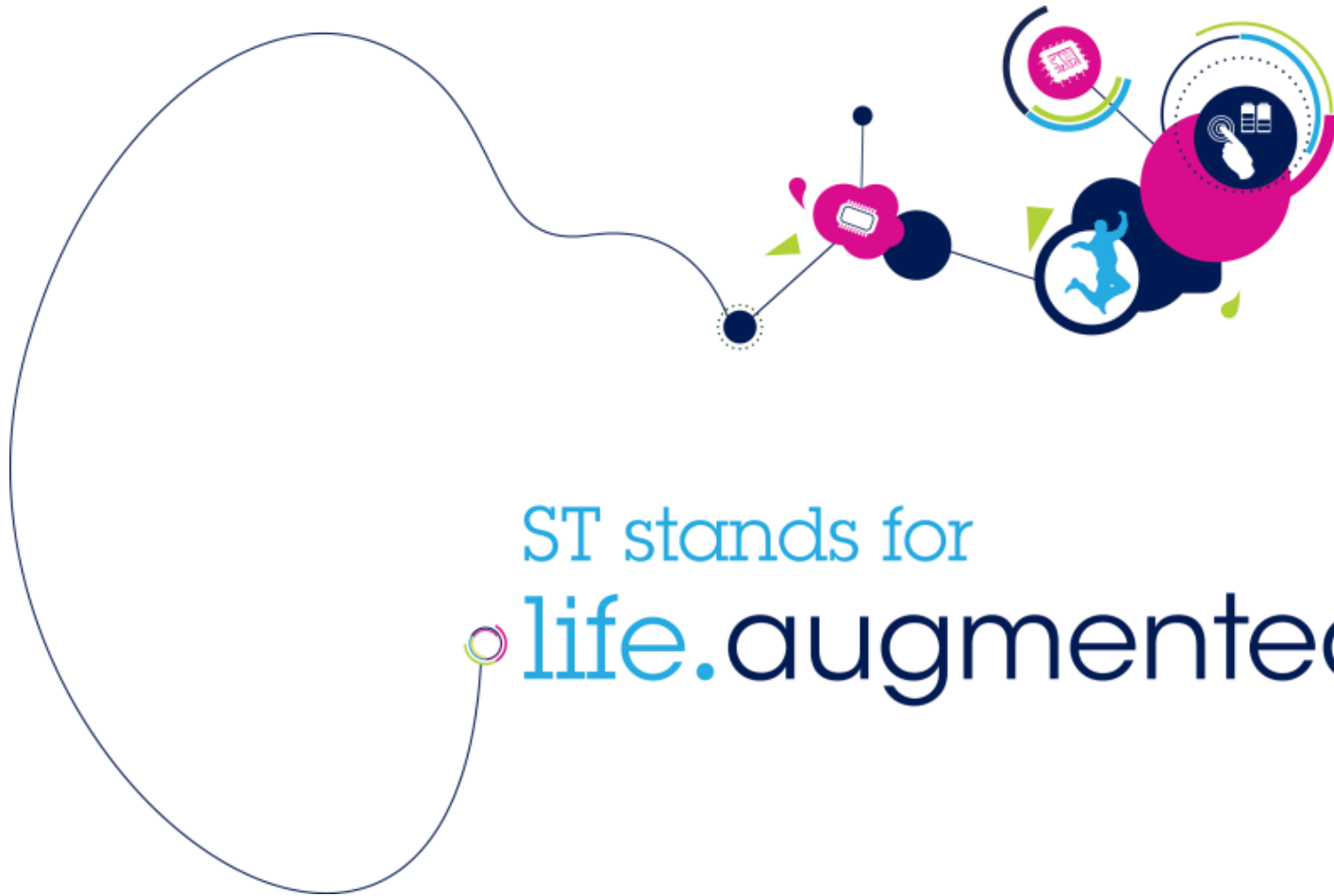

ST stands for  
**life.augmented**

## Looking for pricing, stock, or lifecycle information?

Click below to explore more details on WIN SOURCE:

- ⊖ [View STEVAL-IDS001V5M on WIN SOURCE](#)
- ⊖ [STMicroelectronics Information](#)

## Optimize Your Supply Chain with WIN SOURCE Solutions

- ✓ Global Sourcing Solution
- ✓ Obsolete Management
- ✓ Cost Control Management
- ✓ Shortage Management
- ✓ Alternative Solution
- ✓ Excess Inventory Management