



**THE DATASHEET OF  
BAS4002ARPPE6327HTSA1**



**Low VF Schottky Diode Array**

- Reverse voltage: 40 V
- Forward current: 0.2 A
- Small diode quad array for polarity independence, reverse polarity protection and low loss bridge rectification
- Very low forward voltage: 0.55 @ 0.1 A (per diode)
- Fast switching
- Pb-free (ROHS compliant) package
- Qualified according AEC Q101

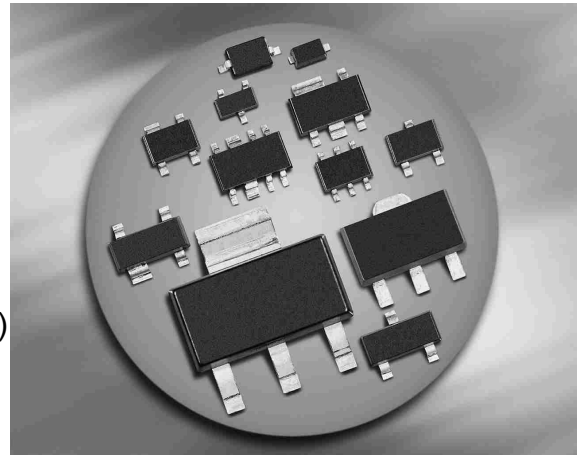
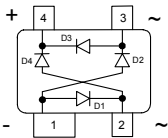
**BAS4002A-RPP**

Type	Package	Configuration	Marking
BAS4002A-RPP	SOT143	bridge	E9s

**Maximum Ratings** at  $T_A = 25\text{ °C}$ , unless otherwise specified

Parameter	Symbol	Value	Unit
Diode reverse voltage <sup>1)</sup>	$V_R$	40	V
Peak reverse voltage <sup>1)</sup>	$V_{RM}$	40	
RMS reverse voltage <sup>1)</sup>	$V_{R(RMS)}$	28	
Forward current <sup>1)</sup> , $T_S \leq 124\text{ °C}$	$I_F$	200	mA
Non-repetitive peak surge forward current ( $t \leq 10\text{ ms}$ )	$I_{FSM}$	2	A
Junction temperature	$T_j$	150	°C
Storage temperature	$T_{stg}$	-65 ... 150	

**Thermal Resistance**

Parameter	Symbol	Value	Unit
Junction - soldering point <sup>2)</sup>	$R_{thJS}$	$\leq 130$	K/W

<sup>1)</sup>For  $T_A > 25\text{ °C}$  the derating of  $V_R$  and  $I_F$  has to be considered.

<sup>2)</sup>For calculation of  $R_{thJA}$  please refer to Application Note Thermal Resistance

**Electrical Characteristics at  $T_A = 25^\circ\text{C}$ , unless otherwise specified**

Parameter	Symbol	Values			Unit
		min.	typ.	max.	
<b>DC Characteristics</b>					
Reverse current <sup>1)</sup> (per diode) $V_R = 30\text{ V}$ $V_R = 40\text{ V}$	$I_R$	-	-	2 10	$\mu\text{A}$
Forward voltage <sup>1) 2)</sup> (per diode) $I_F = 10\text{ mA}$ $I_F = 60\text{ mA}$ $I_F = 100\text{ mA}$ $I_F = 200\text{ mA}$	$V_F$	-	0.39 0.49 0.55 0.69	0.44 0.55 0.62 0.79	V
<b>AC Characteristics</b>					
Diode capacitance (per diode) $V_R = 5\text{ V}, f = 1\text{ MHz}$	$C_T$	-	2	5	pF

<sup>1</sup>Pulsed test,  $t_p = 300\ \mu\text{s}$ ;  $D = 0.01$

<sup>2</sup>When used as shown for Reverse Polarity Protection (RPP, see page 4), the voltage available to the circuit being protected will be two diode drops below the power supply voltage. In other words, the supply current will pass through two diodes.

**Diode capacitance  $C_T = f(V_R)$**

$f = 1\text{MHz}$  (per diode)

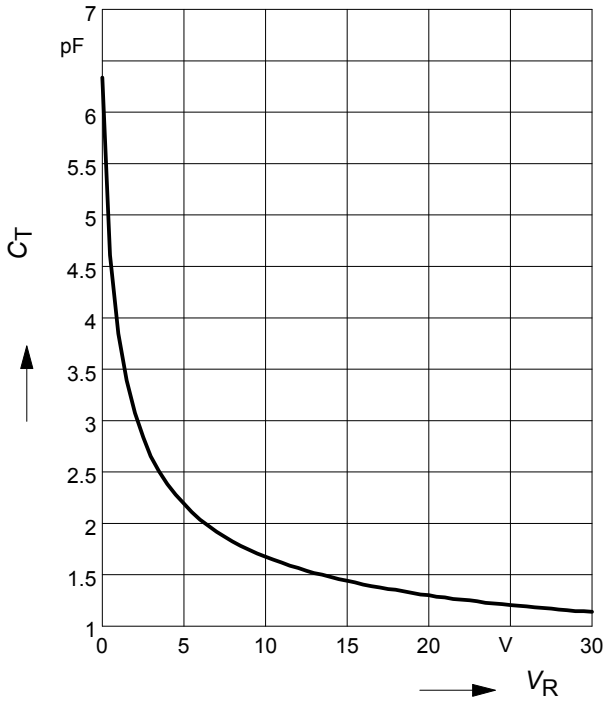

**Reverse current  $I_R = f(T_A)$**

$V_R = \text{Parameter}$  (per diode)

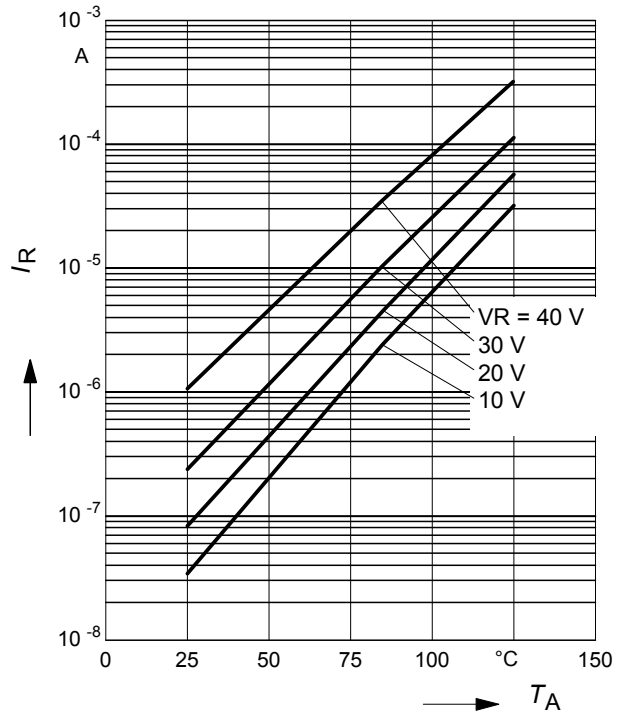

**Reverse current  $I_R = f(V_R)$**

$T_A = \text{Parameter}$  (per diode)

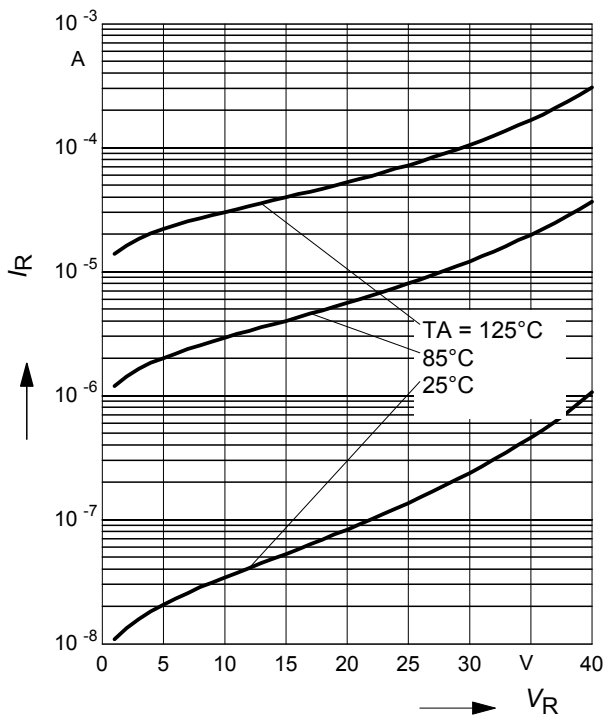

**Forward Voltage  $V_F = f(T_A)$**

$I_F = \text{Parameter}$  (per diode)

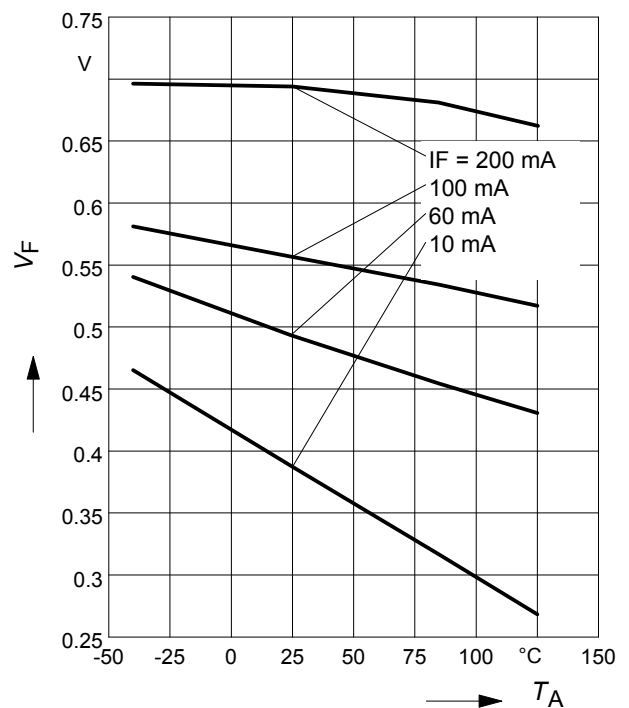

**Forward current  $I_F = f(V_F)$**   
(per diode)

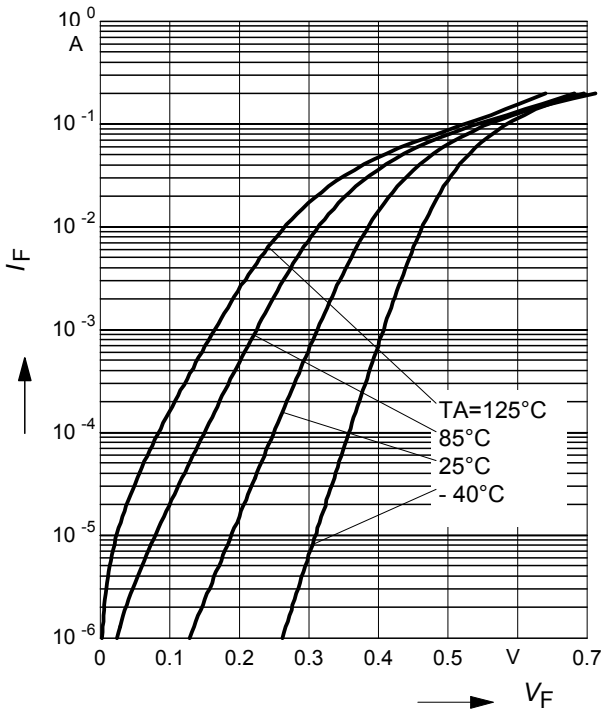

**Forward current  $I_F = f(T_S)$**   
BAS4002-RPP

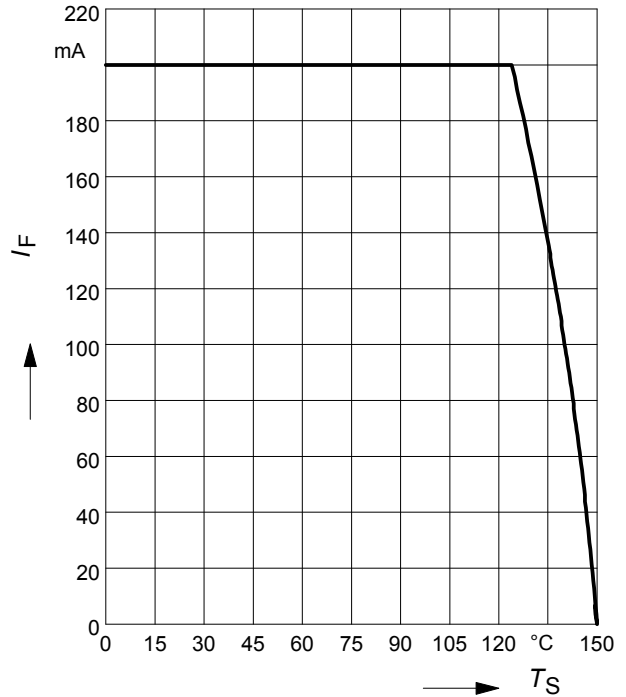

**Application example BAS4002A-RPP**

Advanced Reverse Polarity Protection(RPP): due to diode orientation, circuit at the right will be protected from damage and will also function normally in the event reverse polarity is applied to pins 2 and 3 of the BAS4002A-RPP.

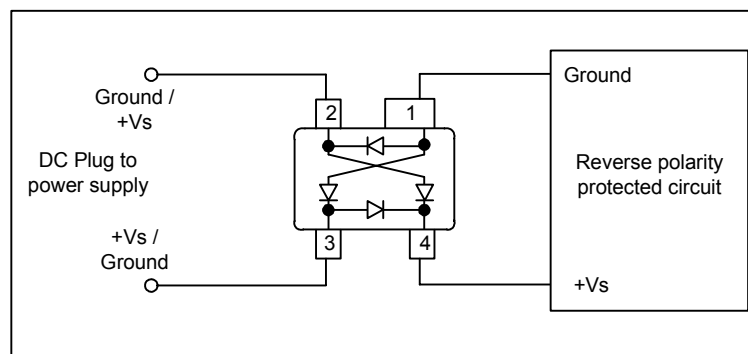

Package Outline

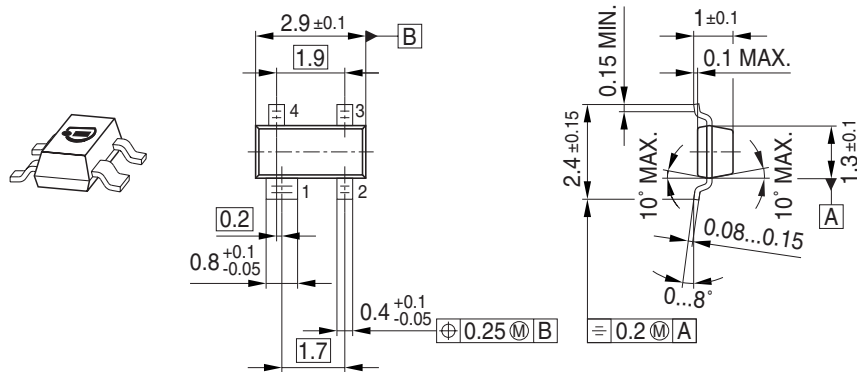

Foot Print

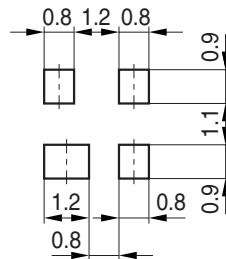

Marking Layout (Example)

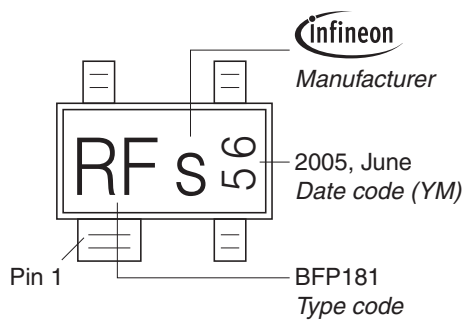

Standard Packing

Reel  $\phi 180 \text{ mm} = 3.000 \text{ Pieces/Reel}$   
 Reel  $\phi 330 \text{ mm} = 10.000 \text{ Pieces/Reel}$

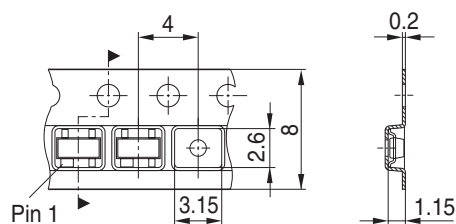

Edition 2006-02-01  
Published by  
Infineon Technologies AG  
81726 München, Germany  
© Infineon Technologies AG 2007.  
All Rights Reserved.

### **Attention please!**

The information given in this dokument shall in no event be regarded as a guarantee of conditions or characteristics ("Beschaffenheitsgarantie"). With respect to any examples or hints given herein, any typical values stated herein and/or any information regarding the application of the device, Infineon Technologies hereby disclaims any and all warranties and liabilities of any kind, including without limitation warranties of non-infringement of intellectual property rights of any third party.

### **Information**

For further information on technology, delivery terms and conditions and prices please contact your nearest Infineon Technologies Office ([www.infineon.com](http://www.infineon.com)).

### **Warnings**

Due to technical requirements components may contain dangerous substances. For information on the types in question please contact your nearest Infineon Technologies Office.

Infineon Technologies Components may only be used in life-support devices or systems with the express written approval of Infineon Technologies, if a failure of such components can reasonably be expected to cause the failure of that life-support device or system, or to affect the safety or effectiveness of that device or system.

Life support devices or systems are intended to be implanted in the human body, or to support and/or maintain and sustain and/or protect human life. If they fail, it is reasonable to assume that the health of the user or other persons may be endangered.

## Looking for pricing, stock, or lifecycle information?

Click below to explore more details on WIN SOURCE:

- ⊖ [View BAS4002ARPPE6327HTSA1 on WIN SOURCE](#)
- ⊖ [Infineon Technologies Information](#)

## Optimize Your Supply Chain with WIN SOURCE Solutions

- ✓ Global Sourcing Solution
- ✓ Obsolete Management
- ✓ Cost Control Management
- ✓ Shortage Management
- ✓ Alternative Solution
- ✓ Excess Inventory Management