



# THE DATASHEET OF S2BA-13



### Features

- Glass Passivated Die Construction
- Low Forward Voltage Drop and High Current Capability
- Surge Overload Rating to 50A Peak
- Ideally Suited for Automated Assembly
- Available in Lead Free Finish/RoHS Compliant Version (Note 3)

### Mechanical Data

- Case: SMA/SMB
- Case Material: Molded Plastic. UL Flammability Classification Rating 94V-0
- Moisture Sensitivity: Level 1 per J-STD-020C
- Also Available in Lead Free Plating (Matte Tin Finish). Please see Ordering Information, Note 5, on Page 2
- Polarity: Cathode Band or Cathode Notch
- Marking: Type Number, See Page 2
- Ordering Information: See Page 2
- Approx. Weight: SMA 0.064 grams  
SMB 0.093 grams

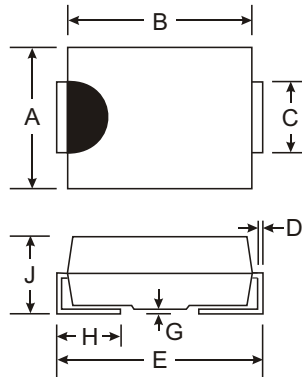

| Dim                  | SMA  |      | SMB  |      |
|----------------------|------|------|------|------|
|                      | Min  | Max  | Min  | Max  |
| A                    | 2.29 | 2.92 | 3.30 | 3.94 |
| B                    | 4.00 | 4.60 | 4.06 | 4.57 |
| C                    | 1.27 | 1.63 | 1.96 | 2.21 |
| D                    | 0.15 | 0.31 | 0.15 | 0.31 |
| E                    | 4.80 | 5.59 | 5.00 | 5.59 |
| G                    | 0.10 | 0.20 | 0.10 | 0.20 |
| H                    | 0.76 | 1.52 | 0.76 | 1.52 |
| J                    | 2.01 | 2.62 | 2.00 | 2.62 |
| All Dimensions in mm |      |      |      |      |

A Suffix Designates SMA Package  
No Suffix Designates SMB Package

@T<sub>A</sub> = 25°C unless otherwise specified

### Maximum Ratings and Electrical Characteristics

Single phase, half wave, 60Hz, resistive or inductive load.  
For capacitive load, derate current by 20%.

| Characteristic  | Symbol   | S2 A/AA     | S2 B/BA | S2 D/DA | S2 G/GA | S2 J/JA | S2 K/KA | S2 M/MA | Unit |
|---|--|-------------|---------|---------|---------|---------|---------|---------|------|
| Peak Repetitive Reverse Voltage<br>Working Peak Reverse Voltage<br>DC Blocking Voltage                          | V <sub>RRM</sub><br>V <sub>RWM</sub><br>V <sub>R</sub> | 50          | 100     | 200     | 400     | 600     | 800     | 1000    | V    |
| RMS Reverse Voltage   | V <sub>R(RMS)</sub>                                    | 35          | 70      | 140     | 280     | 420     | 560     | 700     | V    |
| Average Rectified Output Current @ T <sub>T</sub> = 100°C   | I <sub>(AV)</sub>                                      | 1.5         |         |         |         |         |         |         | A    |
| Non-Repetitive Peak Forward Surge Current 8.3ms single half sine-wave superimposed on rated load (JEDEC Method) | I <sub>FSM</sub>                                       | 50          |         |         |         |         |         |         | A    |
| Forward Voltage @ I <sub>F</sub> = 1.5A   | V <sub>FM</sub>  | 1.15        |         |         |         |         |         |         | V    |
| Peak Reverse Current @ T <sub>A</sub> = 25°C<br>at Rated DC Blocking Voltage @ T <sub>A</sub> = 125°C           | I <sub>RM</sub>  | 5.0<br>125  |         |         |         |         |         |         | μA   |
| Typical Total Capacitance (Note 1)  | C <sub>T</sub>   | 20          |         |         |         |         |         |         | pF   |
| Typical Thermal Resistance, Junction to Terminal (Note 2)   | R <sub>θJT</sub>                                       | 20          |         |         |         |         |         |         | °C/W |
| Operating and Storage Temperature Range   | T <sub>j</sub> , T <sub>STG</sub>                      | -65 to +150 |         |         |         |         |         |         | °C   |

- Notes:
1. Measured at 1.0 MHz and applied reverse voltage of 4.0V DC.
  2. Thermal Resistance Junction to Terminal, unit mounted on PC board with 5.0 mm<sup>2</sup> (0.013 mm thick) copper pads as heat sink.
  3. RoHS revision 13.2.2003. Glass and High Temperature Solder Exemptions Applied, see EU Directive Annex Notes 5 and 7.

## Ordering Information (Note 4)

| Device*           | Packaging  | Shipping                             |
|-------------------|------------|--------------------------------------|
| S2xA-13<br>S2X-13 | SMA<br>SMB | 5000/Tape & Reel<br>3000/Tape & Reel |

\* x = Device type, e.g. S2AA-13 (SMA package); S2A-13 (SMB package).

- Notes: 4. For Packaging Details, go to our website at <http://www.diodes.com/datasheets/ap02007.pdf>.  
5. For Lead Free Finish/RoHS Compliant version part number, please add "-F" suffix to the part number above. Example: S2A-13-F.

## Marking Information

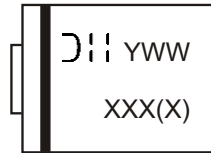

XXX = Product type marking code, ex: S2A (SMB package)  
 XXXX = Product type marking code, ex: S2AA (SMA package)  
 D; ; = Manufacturers' code marking  
 YWW = Date code marking  
 Y = Last digit of year ex: 2 for 2002  
 WW = Week code 01 to 52

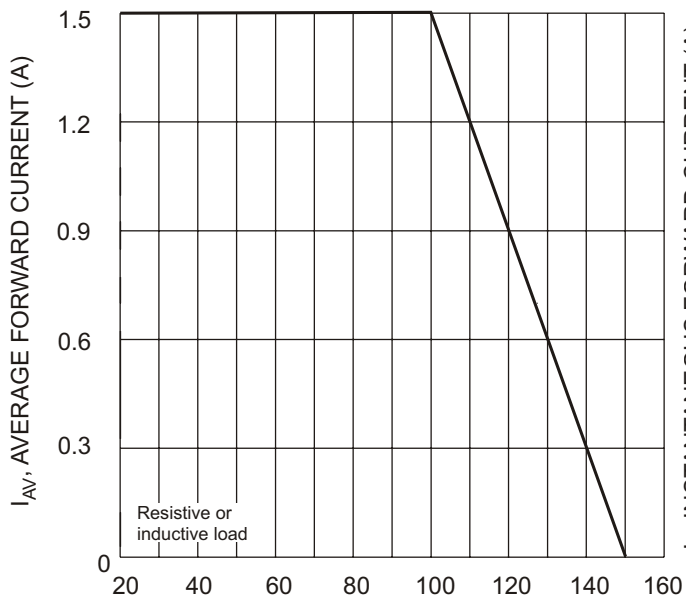

$T_T$ , TERMINAL TEMPERATURE (°C)  
Fig. 1 Forward Current Derating Curve

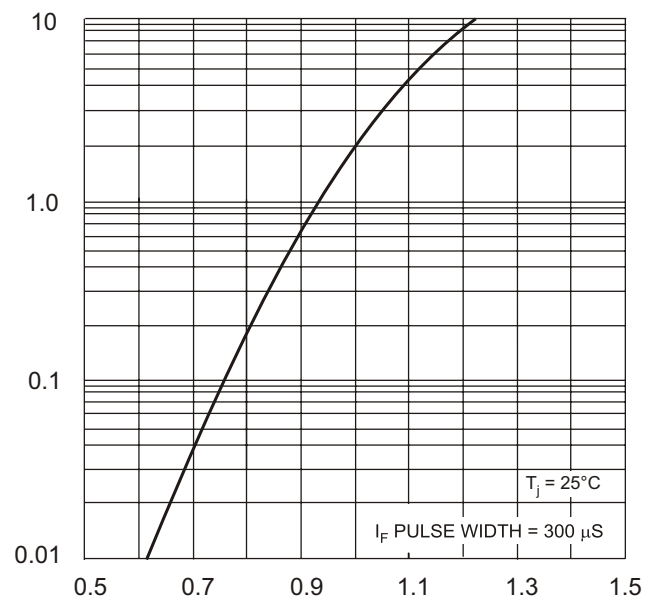

$V_F$ , INSTANTANEOUS FORWARD VOLTAGE (V)  
Fig. 2 Typical Forward Characteristics

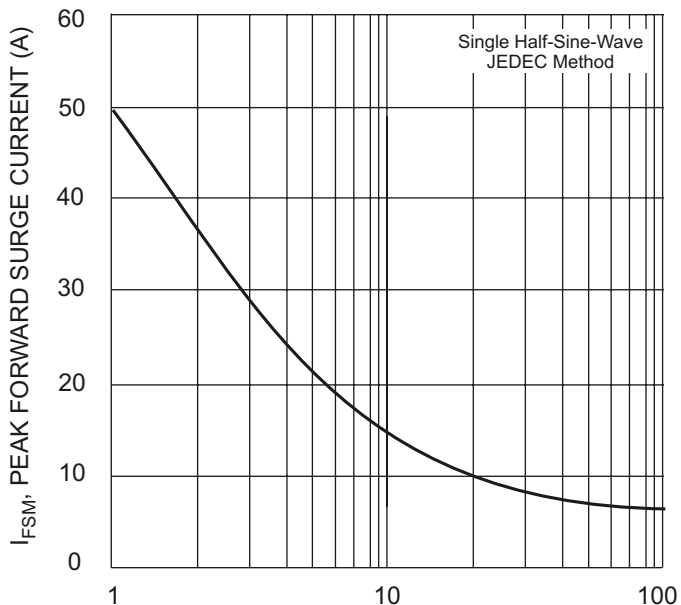

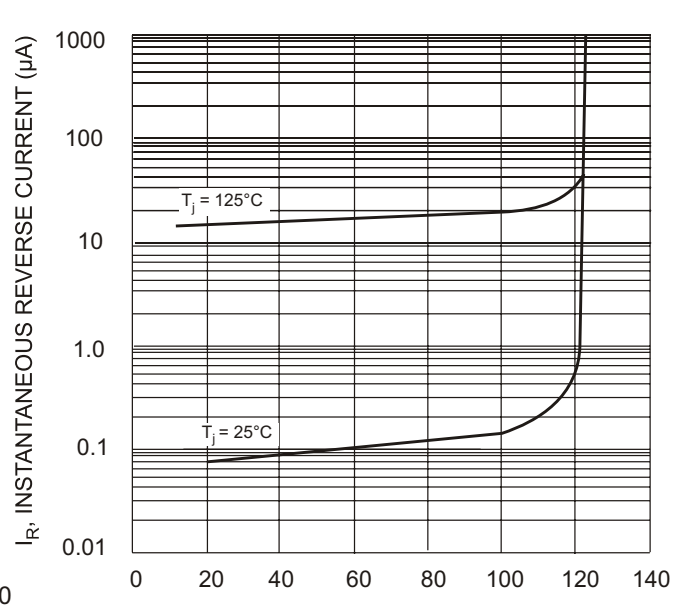

NUMBER OF CYCLES AT 60 Hz  
Fig. 3 Forward Surge Current Derating Curve



PERCENT OF RATED PEAK REVERSE VOLTAGE (%)  
Fig. 4 Typical Reverse Characteristics

## Looking for pricing, stock, or lifecycle information?

Click below to explore more details on WIN SOURCE:

-  [View S2BA-13 on WIN SOURCE](#)
-  [Diodes Incorporated Information](#)

## Optimize Your Supply Chain with WIN SOURCE Solutions

-  Global Sourcing Solution
-  Obsolete Management
-  Cost Control Management
-  Shortage Management
-  Alternative Solution
-  Excess Inventory Management