



# THE DATASHEET OF SM4934-TP



NOT RECOMMENDED FOR NEW DESIGNS



Micro Commercial Components

Micro Commercial Components  
20736 Marilla Street Chatsworth  
CA 91311  
Phone: (818) 701-4933  
Fax: (818) 701-4939

# SM4933 THRU SM4937

## Features

- Halogen free available upon request by adding suffix "-HF"
- Lead Free Finish/RoHS Compliant(NOTE 1) ("P" Suffix designates RoHS Compliant. See ordering information)
- Epoxy meets UL 94 V-0 flammability rating
- Moisture Sensitivity Level 1
- Metalurgically Bonded Construction
- Low Cost and Low Leakage Current
- Fast Switching

## Maximum Ratings

- Operating Temperature: -55°C to +150°C
- Storage Temperature: -55°C to +150°C
- Maximum Thermal Resistance; 30°C/W Junction To Lead

MCC Catalog Number	Device Marking	Maximum Recurrent Peak Reverse Voltage	Maximum RMS Voltage	Maximum DC Blocking Voltage
SM4933	4933	50V	35V	50V
SM4934	4934	100V	70V	100V
SM4935	4935	200V	140V	200V
SM4936	4936	400V	280V	400V
SM4937	4937	600V	420V	600V

## 1 Amp Fast Recovery Rectifier 50 - 600 Volts

### DO-214AC (H SMA) (High Profile)

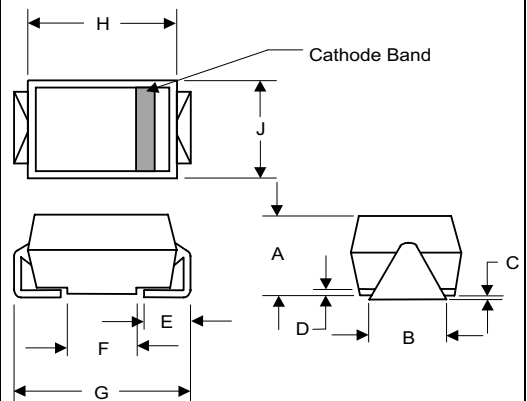

DIM	DIMENSIONS				NOTE
	INCHES		MM		
A	.078	.116	1.98	2.95	
B	.067	.089	1.70	2.25	
C	.002	.008	.05	.20	
D	---	.02	---	.51	
E	.035	.055	.89	1.40	
F	.065	.096	1.65	2.45	
G	.205	.224	5.21	5.69	
H	.160	.180	4.06	4.57	
J	.100	.112	2.57	2.84	

#### SUGGESTED SOLDER PAD LAYOUT

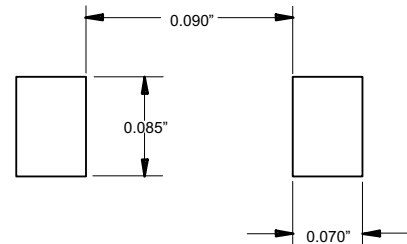

### Electrical Characteristics @ 25°C Unless Otherwise Specified

Average Forward Current	$I_{F(AV)}$	1.0A	$T_A = 55^\circ\text{C}$
Peak Forward Surge Current	$I_{FSM}$	30A	8.3ms, half sine
Maximum Instantaneous Forward Voltage	$V_F$	1.3V	$I_{FM} = 1.0\text{A};$ $T_J = 25^\circ\text{C}^*$
Maximum DC Reverse Current At Rated DC Blocking Voltage	$I_R$	5.0 $\mu\text{A}$ 100 $\mu\text{A}$	$T_J = 25^\circ\text{C}$ $T_J = 125^\circ\text{C}$
Maximum Reverse Recovery Time	$T_{rr}$	200ns	$I_F = 1.0\text{A},$ $V_R = 30\text{V}$
Typical Junction Capacitance	$C_J$	15pF	Measured at 1.0MHz, $V_R = 4.0\text{V}$

\*Pulse test: Pulse width 300  $\mu\text{sec}$ , Duty cycle 1%

Note: 1. High Temperature Solder Exemptions Applied, see EU Directive Annex 7.

[www.mccsemi.com](http://www.mccsemi.com)

# SM4933 thru SM4937

Figure 1  
Typical Forward Characteristics

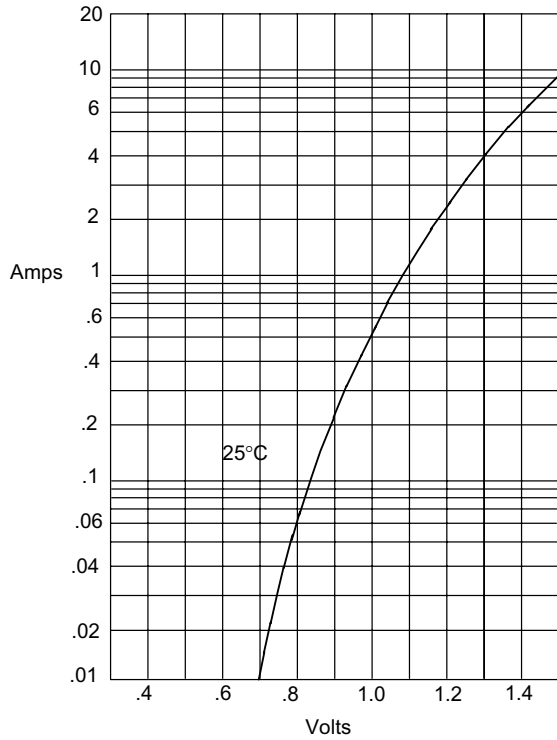

Instantaneous Forward Current - Amperes *versus*  
Instantaneous Forward Voltage - Volts

Figure 2  
Forward Derating Curve

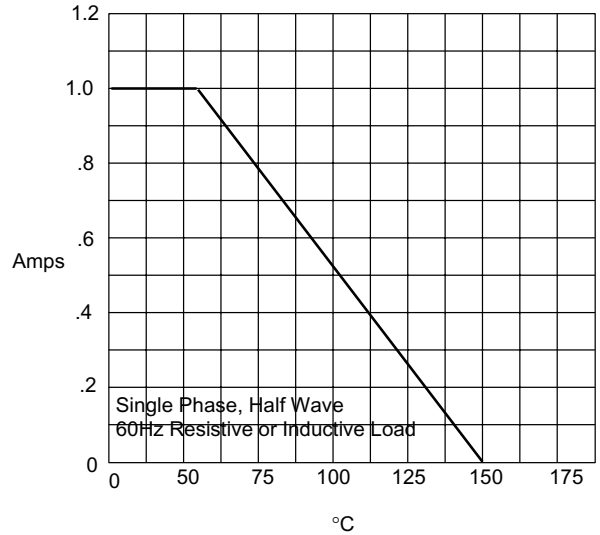

Average Forward Rectified Current - Amperes *versus*  
Ambient Temperature - °C

Figure 3  
Junction Capacitance

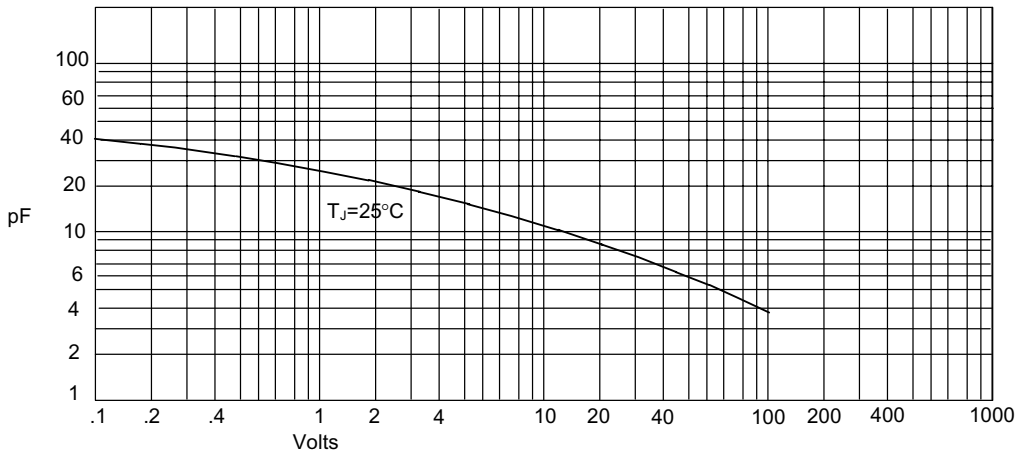

Junction Capacitance - pF *versus*  
Reverse Voltage - Volts

# SM4933 thru SM4937

Figure 4  
Typical Reverse Characteristics

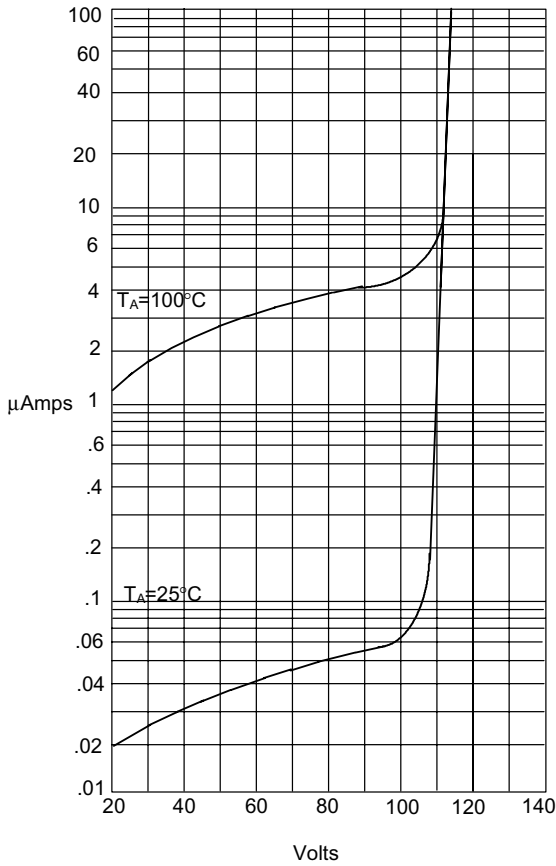

Instantaneous Reverse Leakage Current - MicroAmperes versus Percent Of Rated Peak Reverse Voltage - Volts

Figure 5  
Peak Forward Surge Current

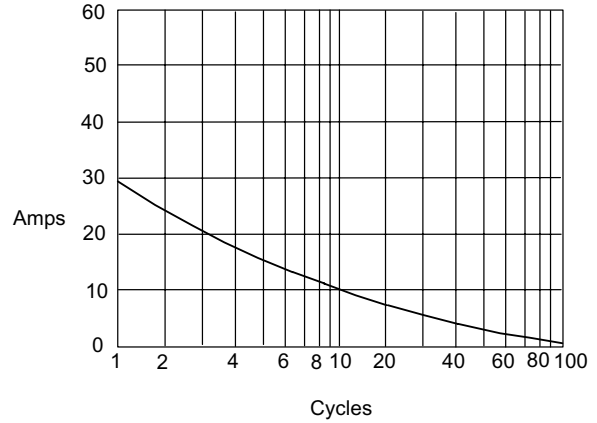

Peak Forward Surge Current - Amperes versus Number Of Cycles At 60Hz - Cycles

Figure 6  
Reverse Recovery Time Characteristic And Test Circuit Diagram

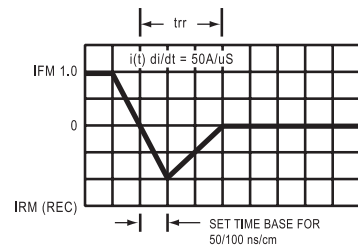
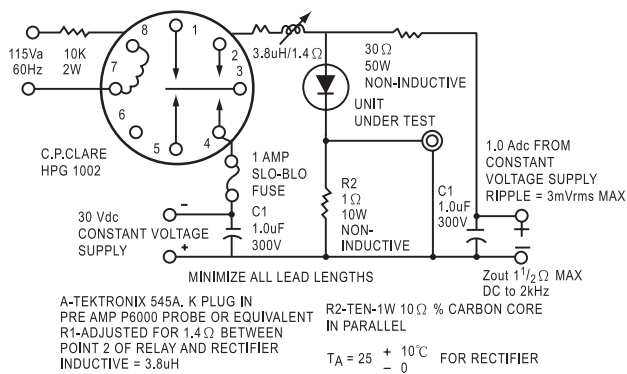



Micro Commercial Components

Ordering Information :

Device	Packing
Part Number-TP	Tape&Reel: 3Kpcs/Reel

Note : Adding "-HF" suffix for halogen free, eg. Part Number-TP-HF

\*\*\*IMPORTANT NOTICE\*\*\*

Micro Commercial Components Corp. reserves the right to make changes without further notice to any product herein to make corrections, modifications , enhancements , improvements , or other changes . Micro Commercial Components Corp . does not assume any liability arising out of the application or use of any product described herein; neither does it convey any license under its patent rights ,nor the rights of others . The user of products in such applications shall assume all risks of such use and will agree to hold Micro Commercial Components Corp . and all the companies whose products are represented on our website, harmless against all damages.

\*\*\*LIFE SUPPORT\*\*\*

MCC's products are not authorized for use as critical components in life support devices or systems without the express written approval of Micro Commercial Components Corporation.

\*\*\*CUSTOMER AWARENESS\*\*\*

Counterfeiting of semiconductor parts is a growing problem in the industry. Micro Commercial Components (MCC) is taking strong measures to protect ourselves and our customers from the proliferation of counterfeit parts. MCC strongly encourages customers to purchase MCC parts either directly from MCC or from Authorized MCC Distributors who are listed by country on our web page cited below. Products customers buy either from MCC directly or from Authorized MCC Distributors are genuine parts, have full traceability, meet MCC's quality standards for handling and storage. MCC will not provide any warranty coverage or other assistance for parts bought from Unauthorized Sources. MCC is committed to combat this global problem and encourage our customers to do their part in stopping this practice by buying direct or from authorized distributors.

## Looking for pricing, stock, or lifecycle information?

Click below to explore more details on WIN SOURCE:

- ⊖ [View SM4934-TP on WIN SOURCE](#)
- ⊖ [Micro Commercial Co](#) Information

## Optimize Your Supply Chain with WIN SOURCE Solutions

- ✓ Global Sourcing Solution
- ✓ Obsolete Management
- ✓ Cost Control Management
- ✓ Shortage Management
- ✓ Alternative Solution
- ✓ Excess Inventory Management