



THE DATASHEET OF SF56-TP



SF51 THRU SF58

5.0 Amp Super Fast Rectifier 50 to 600 Volts

Features

- Lead Free Finish/RoHS Compliant(Note 1) ("P" Suffix designates RoHS Compliant. See ordering information)
- Low forward voltage, high current capability and Low leakage
- Superfast recovery times-epitaxial construction
- Epoxy meets UL 94 V-0 flammability rating
- Moisture Sensitivity Level 1
- Halogen free available upon request by adding suffix "-HF"

Maximum Ratings

- Operating Junction Temperature: -55°C to +150°C
- Storage Temperature: -55°C to +150°C
- Maximum Thermal Resistance; 25°C/W Junction To Ambient

MCC Part Number	Maximum Recurrent Peak Reverse Voltage	Maximum RMS Voltage	Maximum DC Blocking Voltage
SF51	50V	35V	50V
SF52	100V	70V	100V
SF53	150V	105V	150V
SF54	200V	140V	200V
SF55	300V	210V	300V
SF56	400V	280V	400V
SF58	600V	420V	600V

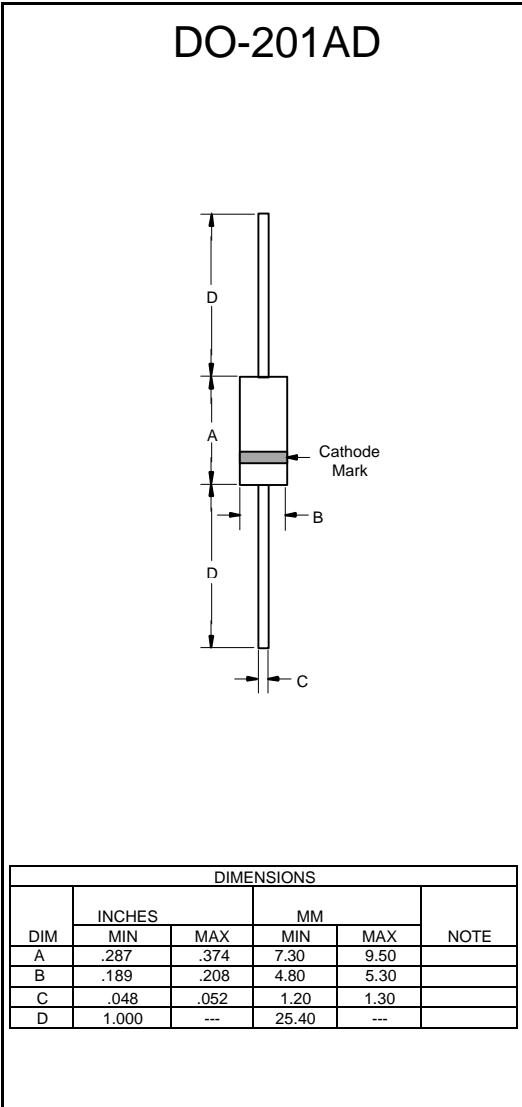

Electrical Characteristics @ 25°C Unless Otherwise Specified

Average Forward Current	$I_{F(AV)}$	5.0A	$T_A = 55^\circ\text{C}$
Peak Forward Surge Current	I_{FSM}	150A	8.3ms, half sine
Maximum Instantaneous Forward Voltage	V_F	SF51-SF54: 0.95V SF55-SF56: 1.25V SF58: 1.70V	$I_{FM} = 5.0A$; $T_A = 25^\circ\text{C}$
Maximum DC Reverse Current At Rated DC Blocking Voltage	I_R	5.0uA 150uA	$T_A = 25^\circ\text{C}$ $T_A = 125^\circ\text{C}$
Typical Junction Capacitance	C_J	45pF	Measured at 1.0MHz, $V_R=4.0V$
Maximum Reverse Recovery Time	T_{RR}	35nS	$I_F=0.5A$, $I_R=1.0A$, $I_{RR}=0.25A$

Notes:1.High Temperature Solder Exemption Applied, see EU Directive Annex 7.

SF51 thru SF58

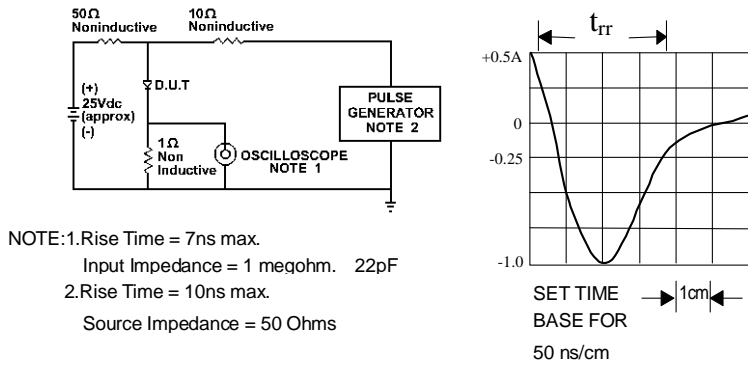

Fig. 1-REVERSE RECOVERY TIME CHARACTERISTIC AND TEST CIRCUIT DIAGRAM

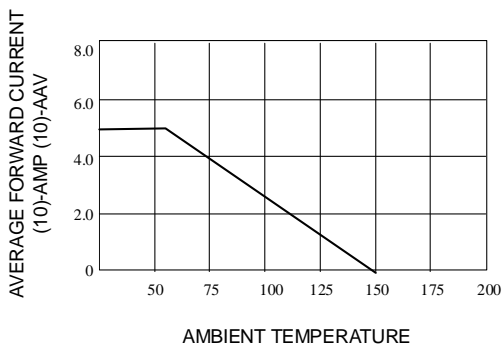

Fig. 2-MAXIMUM AVERAGE FORWARD CURRENT RATING

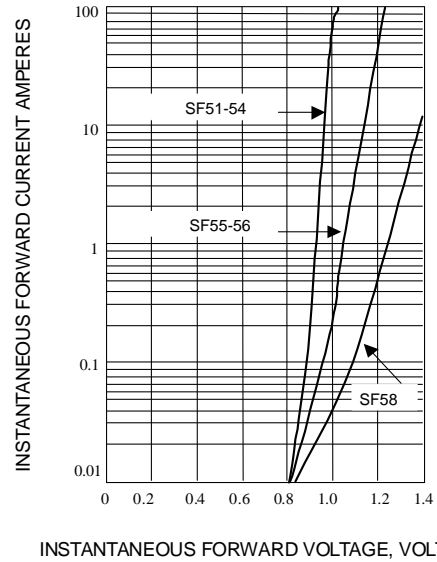

Fig. 3-FORWARD CURRENT DERATING CURVE

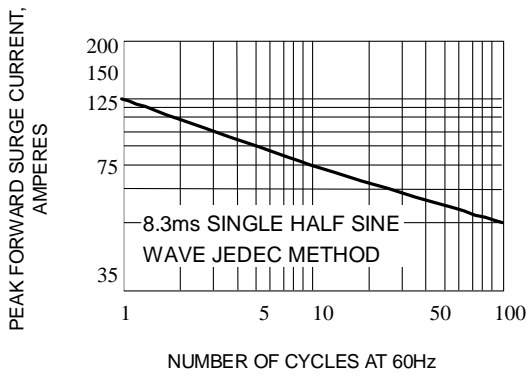

Fig. 4-MAXIMUM NON-REPETITIVE SURGE CURRENT

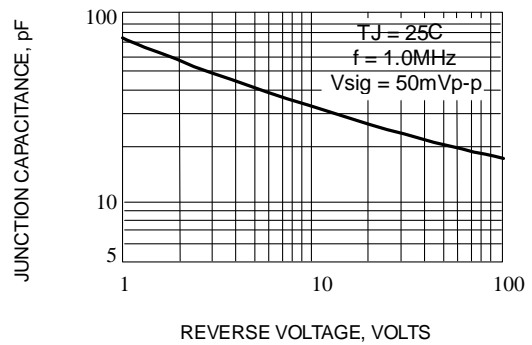

Fig. 5-TYPICAL JUNCTION CAPACITANCE



Ordering Information :

Device	Packing
Part Number-TP	Tape&Reel: 1.2Kpcs/Reel
Part Number-AP	Ammo Packing: 1.2Kpcs/Ammo Box
Part Number-BP	Bulk: 12Kpcs/Carton

Note : Adding "-HF" suffix for halogen free, eg. Part Number-TP-HF

*****IMPORTANT NOTICE*****

Micro Commercial Components Corp. reserves the right to make changes without further notice to any product herein to make corrections, modifications , enhancements , improvements , or other changes . **Micro Commercial Components Corp .** does not assume any liability arising out of the application or use of any product described herein; neither does it convey any license under its patent rights ,nor the rights of others . The user of products in such applications shall assume all risks of such use and will agree to hold **Micro Commercial Components Corp .** and all the companies whose products are represented on our website, harmless against all damages.

*****LIFE SUPPORT*****



MCC's products are not authorized for use as critical components in life support devices or systems without the express written approval of Micro Commercial Components Corporation.

*****CUSTOMER AWARENESS*****





Counterfeiting of semiconductor parts is a growing problem in the industry. Micro Commercial Components (MCC) is taking strong measures to protect ourselves and our customers from the proliferation of counterfeit parts. MCC strongly encourages customers to purchase MCC parts either directly from MCC or from Authorized MCC Distributors who are listed by country on our web page cited below. Products customers buy either from MCC directly or from Authorized MCC Distributors are genuine parts, have full traceability, meet MCC's quality standards for handling and storage. **MCC will not provide any warranty coverage or other assistance for parts bought from Unauthorized Sources.** MCC is committed to combat this global problem and encourage our customers to do their part in stopping this practice by buying direct or from authorized distributors.

Looking for pricing, stock, or lifecycle information?

Click below to explore more details on WIN SOURCE:

-  [View SF56-TP on WIN SOURCE](#)
-  [Micro Commercial Co](#) Information

Optimize Your Supply Chain with WIN SOURCE Solutions

-  Global Sourcing Solution
-  Obsolete Management
-  Cost Control Management
-  Shortage Management
-  Alternative Solution
-  Excess Inventory Management