

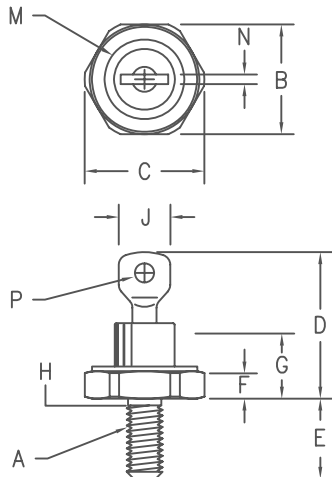

THE DATASHEET OF
S204120



Silicon Power Rectifier S/R204 Series



Notes:

1. 10-32 UNF3A
2. Full threads within 2 1/2 threads
3. Standard Polarity: Stud is Cathode
Reverse Polarity: Stud is Anode

Dim.	Inches		Millimeter		Notes
	Minimum	Maximum	Minimum	Maximum	
A	---	---	---	---	1
B	.424	.437	10.77	11.10	
C	---	.505	---	12.82	
D	.600	.800	15.24	20.32	
E	.422	.453	10.72	11.50	
F	.075	.175	1.91	4.44	
G	---	.405	---	10.29	
H	.163	.189	4.15	4.80	2
J	---	.310	---	7.87	
M	---	.350	---	8.89	Dia
N	.020	.065	.510	1.65	
P	.070	.100	1.78	2.54	Dia

D0203AA (D04)

Microsemi Catalog Number Standard	JEDEC Numbers	Peak Reverse Voltage
*S20410	1N1199, 1N1199A, 1N1199B	50V
	1N1200, 1N1200A, 1N1200B	100V
	1N1201, 1N1201A, 1N1201B	150V
*S20420	1N1124,A, 1N1202, 1N1202A, 1N1202B	200V
	1N1125,A, 1N1203, 1N1203A, 1N1203B	300V
*S20440	1N1126,A, 1N1204, 1N1204A, 1N1204B	400V
	1N1127,A, 1N1205, 1N1205A, 1N1205B	500V
*S20460	1N1128,A, 1N1206, 1N1206A, 1N1206B	600V
*S20480		800V
*S204100		1000V
*S204120		1200V

*Change S to R in part number for Reverse Polarity
For JEDEC numbers add R to part number for Reverse Polarity
NOTE: The Reverse Polarity For the A & B versions may be listed as RA or RB instead of AR or BR

- Glass Passivated Die
- Low Forward Voltage
- 250A Surge Rating
- Glass to metal seal construction
- V_{RRM} to 1200V
- Low cost Non-RoHS package

Electrical Characteristics

Average forward current	$I_F(AV)$ 12 Amps	$T_C = 170^\circ C$, half sine wave, $R_{\theta JC} = 2.5^\circ C/W$ 8.3ms, half sine, $T_J = 200^\circ C$
Maximum surge current	I_{FSM} 250 Amps	
Max $I^2 t$ for fusing	$I^2 t$ 260 $A^2 s$	$I_{FM} = 30A$; $T_J = 25^\circ C$ * $V_{RRM}, T_J = 25^\circ C$ $V_{RRM}, T_J = 150^\circ C$ *
Max peak forward voltage	V_{FM} 1.2 Volts	
Max peak reverse current	I_{RM} 10 μA	
Max peak reverse current	I_{RM} 1.0 mA	
Max Recommended Operating Frequency	10kHz	

*Pulse test: Pulse width 300 μsec . Duty cycle 2%

Thermal and Mechanical Characteristics

Storage temperature range	T_{STG}	$-65^\circ C$ to $200^\circ C$
Operating junction temp range	T_J	$-65^\circ C$ to $200^\circ C$
Maximum thermal resistance	$R_{\theta JC}$	2.5 $^\circ C/W$ Junction to Case
Mounting torque		25-30 inch pounds
Weight		.16 ounces (5.0 grams) typical

S/R204

Figure 1
Typical Forward Characteristics

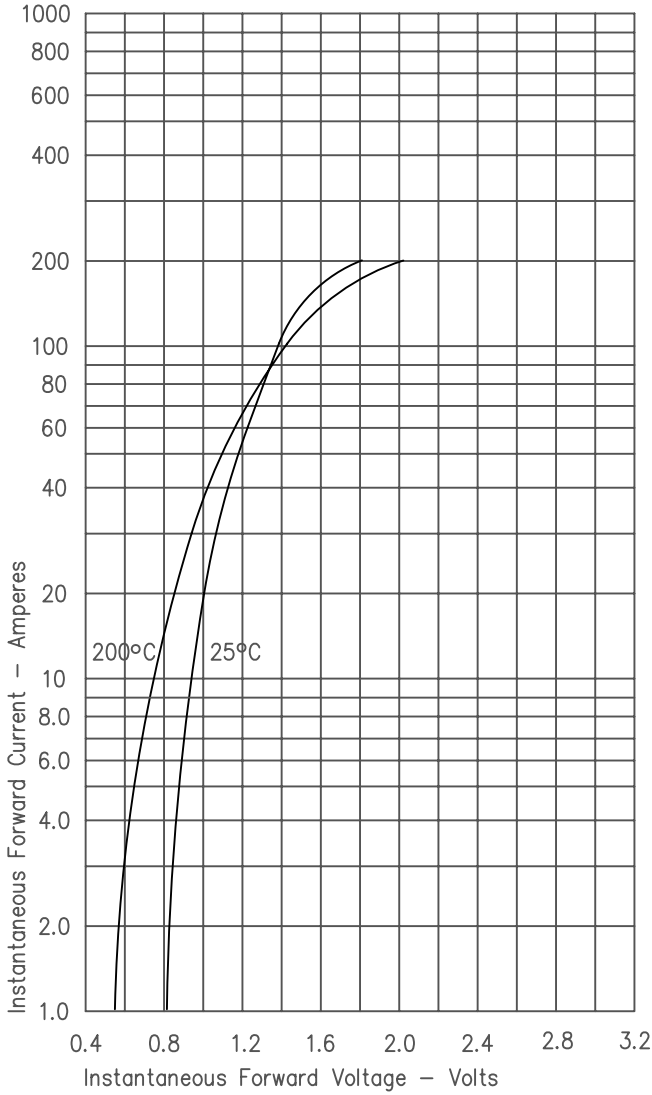

Figure 3
Forward Current Derating

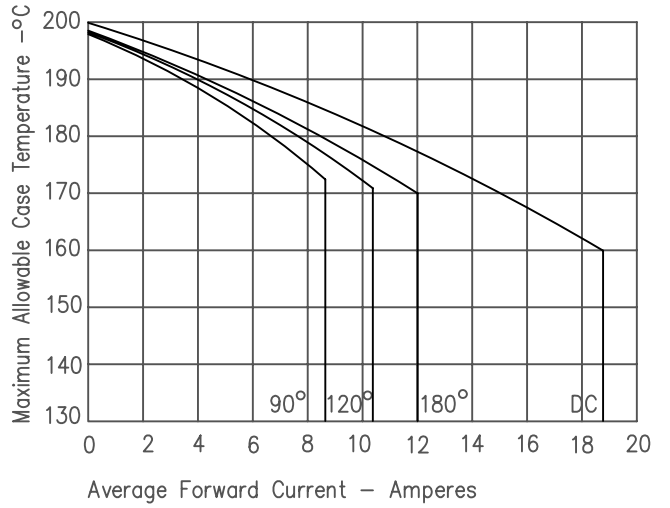

Figure 4
Maximum Forward Power Dissipation

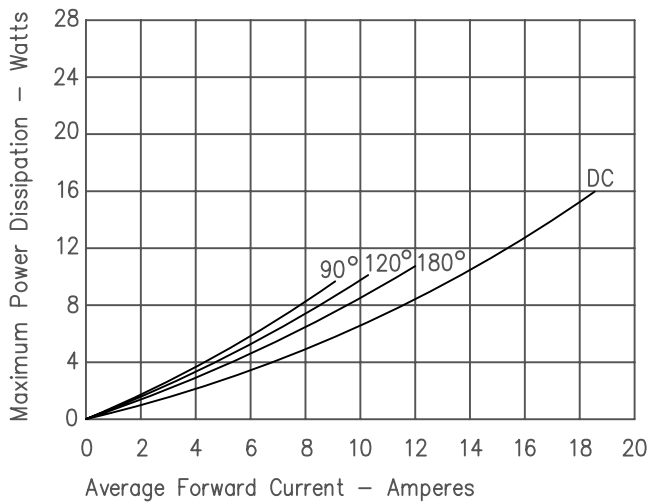

Figure 2
Typical Reverse Characteristics

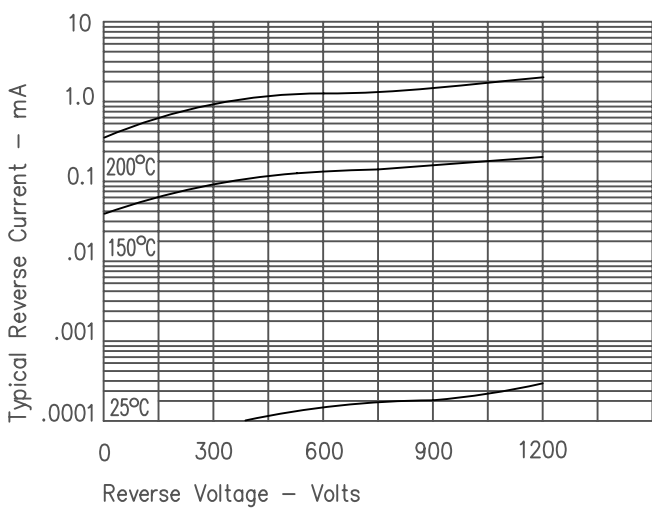
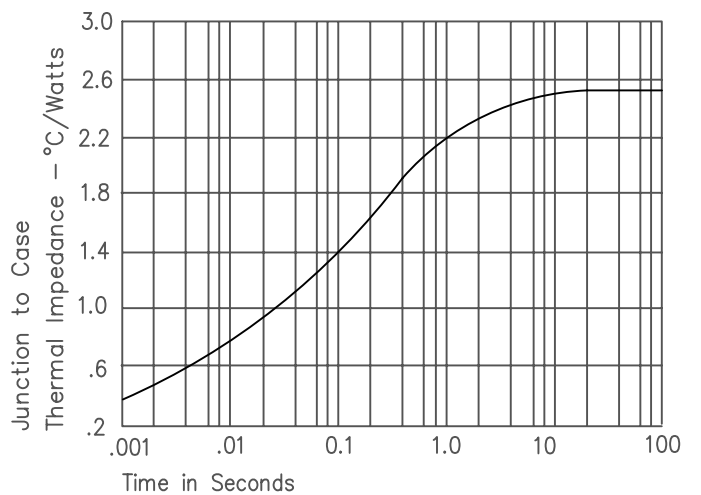



Figure 5
Transient Thermal Impedance



Looking for pricing, stock, or lifecycle information?

Click below to explore more details on WIN SOURCE:

-  [View S204120 on WIN SOURCE](#)
-  [Microchip Technology](#) Information

Optimize Your Supply Chain with WIN SOURCE Solutions

-  Global Sourcing Solution
-  Obsolete Management
-  Cost Control Management
-  Shortage Management
-  Alternative Solution
-  Excess Inventory Management