

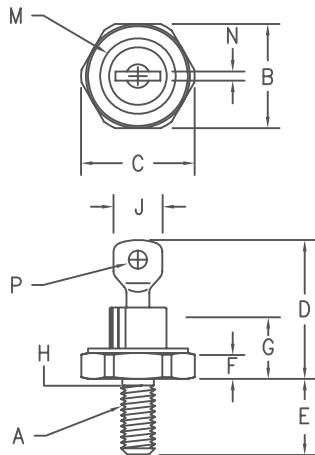

THE DATASHEET OF S2140



Silicon Power Rectifier S/R21 Series



Notes:

1. 10-32 UNF3A
2. Full threads within 2 1/2 threads
3. Standard Polarity: Stud is Cathode
Reverse Polarity: Stud is Anode

Dim.	Inches		Millimeter		Notes
	Minimum	Maximum	Minimum	Maximum	
A	---	---	---	---	1
B	.424	.437	10.77	11.10	
C	---	.505	---	12.82	
D	.600	.800	15.24	20.32	
E	.422	.453	10.72	11.50	
F	.075	.175	1.91	4.44	
G	---	.405	---	10.29	
H	.163	.189	4.15	4.80	2
J	---	.310	---	7.87	
M	---	.350	---	8.89	Dia
N	.020	.065	.510	1.65	
P	.070	.100	1.78	2.54	Dia

D0203AA (D04)

Microsemi Catalog Number	JEDEC Numbers	Peak Reverse Voltage
1N2246,A 1N2248,A	1N2598	50V 100V 150V
*S2120	1N2250,A 1N2252,A	200V 300V
*S2140	1N2254,A 1N2256,A	400V 500V
*S2160	1N2258,A	600V
*S2180	1N2260,A 1N3670,A 1N3671,A 1N3672,A	700V 800V 900V
*S21100 *S21120 *S21140 *S21160	1N2262,A 1N2264,A 1N5331	1000V 1200V 1400V 1600V

*Change S to R in part number for Reverse Polarity
For 1N types, use an R suffix for Reverse Polarity

- Glass Passivated Die
- Low Forward Voltage
- 250A Surge Rating
- Glass to metal seal construction
- V_{RRM} to 1600V
- Low cost Non-RoHS package

Electrical Characteristics

Average forward current	IF(AV) 22 Amps	$T_C = 134^\circ\text{C}$, half sine wave, $R_{\theta JC} = 2.5^\circ\text{C/W}$ 8.3ms, half sine, $T_J = 200^\circ\text{C}$
Maximum surge current	IFSM 250 Amps	
Max $I^2 t$ for fusing	$I^2 t$ 260 A ² s	
Max peak forward voltage	V_{FM} 1.2 Volts	$I_{FM} = 30\text{A}; T_J = 25^\circ\text{C}^*$
Max peak reverse current	I_{RM} 10 μA	$V_{RRM}, T_J = 25^\circ\text{C}$
Max peak reverse current	I_{RM} 1.0 mA	$V_{RRM}, T_J = 150^\circ\text{C}$
Max Recommended Operating Frequency	10kHz	

*Pulse test: Pulse width 300 μsec . Duty cycle 2%

Thermal and Mechanical Characteristics

Storage temperature range	T_{STG}	-65°C to 200°C
Operating junction temp range	T_J	-65°C to 200°C
Maximum thermal resistance	$R_{\theta JC}$	2.5°C/W Junction to Case
Mounting torque		25-30 inch pounds
Weight		.16 ounces (5.0 grams) typical

S/R21

Figure 1
Maximum Forward Characteristics

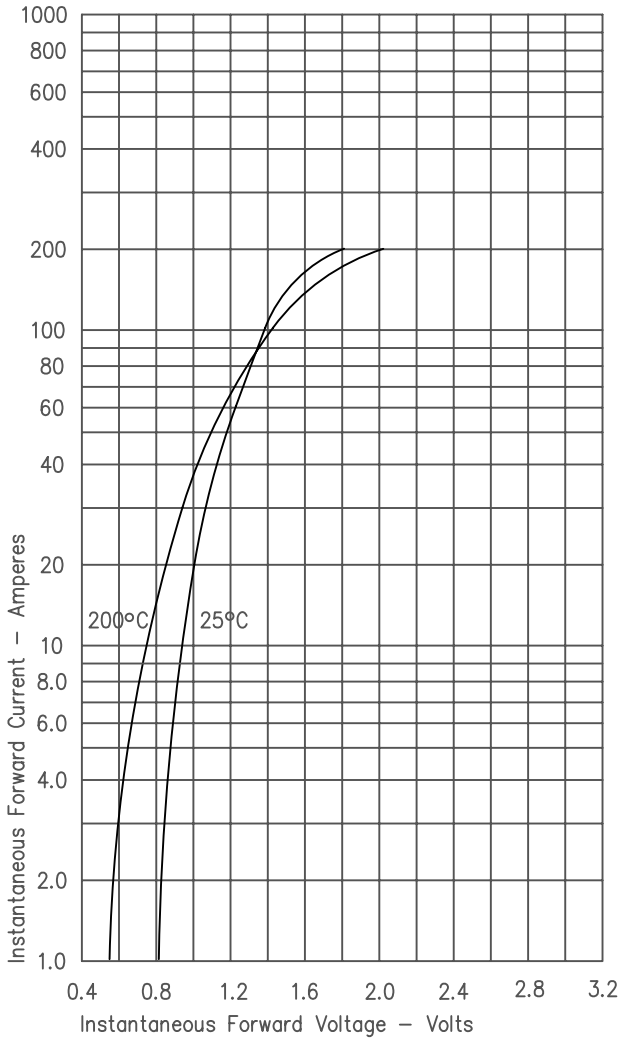

Figure 3
Forward Current Derating

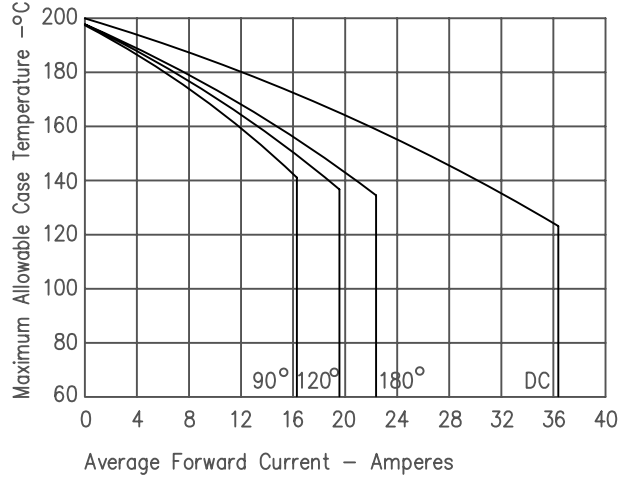

Figure 4
Maximum Forward Power Dissipation

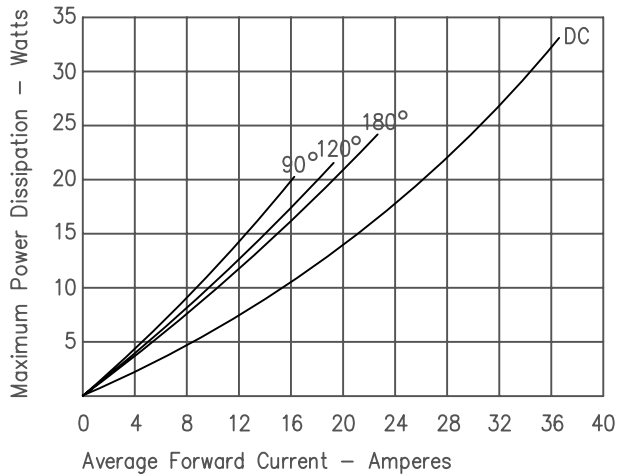

Figure 2
Typical Reverse Characteristics

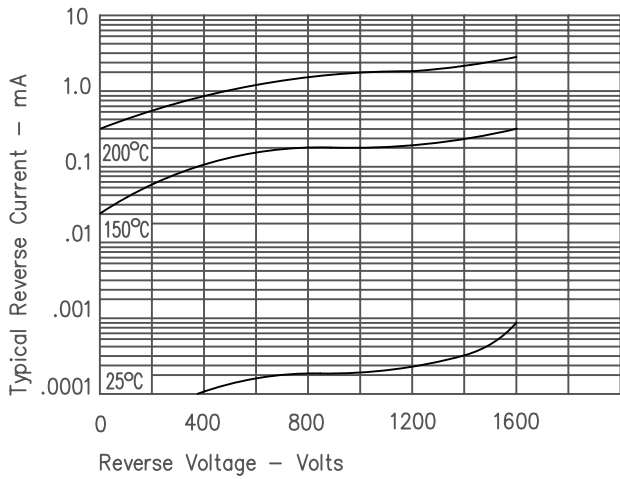
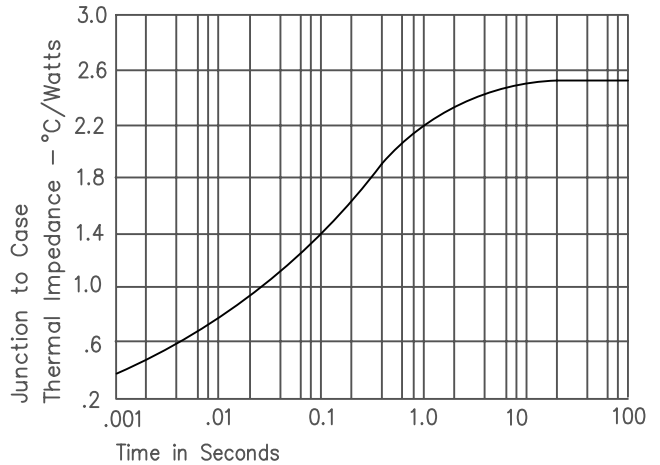



Figure 5
Transient Thermal Impedance



Looking for pricing, stock, or lifecycle information?

Click below to explore more details on WIN SOURCE:

-  [View S2140 on WIN SOURCE](#)
-  [Microchip Technology](#) Information

Optimize Your Supply Chain with WIN SOURCE Solutions

-  Global Sourcing Solution
-  Obsolete Management
-  Cost Control Management
-  Shortage Management
-  Alternative Solution
-  Excess Inventory Management