

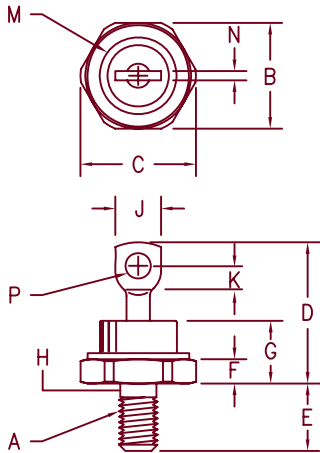

# Silicon Power Rectifier S/R37 Series



- Notes:
- 1/4-28 3A
  - Full threads within 2 1/2 threads
  - Standard polarity:  
Stud is cathode  
Reverse polarity:  
Stud is anode

Dim.	Inches		Millimeter		Notes
	Minimum	Maximum	Minimum	Maximum	
A	---	---	---	---	1
B	.667	.687	16.95	17.44	
C	---	.793	---	20.14	
D	---	1.00	---	25.40	
E	.422	.453	10.72	11.50	
F	.115	.200	2.93	5.08	
G	---	.450	---	11.43	
H	.220	.249	5.59	6.32	2
J	.250	.375	6.35	9.52	
K	.156	---	3.97	---	
M	---	.667	---	16.94	Dia
N	---	.080	---	2.03	
P	.140	.175	3.56	4.44	Dia

D0203AB (D05)

Microsemi Catalog Number Standard	Reverse	Peak Reverse Voltage
S3720	R3720	200V
S3740	R3740	400V
S3760	R3760	600V
S3780	R3780	800V
S37100	R37100	1000V
S37120	R37120	1200V
S37140	R37140	1400V
S37160	R37160	1600V

- Glass Passivated Die
- 1500 Amps Surge Rating
- Glass to metal seal construction
- VRRM to 1600V
- Excellent reliability

## Electrical Characteristics

Average forward current	I <sub>F(AV)</sub> 85 Amps	T <sub>C</sub> = 147°C, Half Sine Wave, <sup>R</sup> θ <sub>JC</sub> = 0.6°C/W
Maximum surge current	I <sub>FSM</sub> 1500 Amps	8.3ms, half sine, T <sub>J</sub> = 200°C
Max I <sup>2</sup> t for fusing	I <sup>2</sup> t 9300 A <sup>2</sup> s	
Max peak forward voltage	V <sub>FM</sub> 1.15 Volts	I <sub>FM</sub> = 200A; T <sub>J</sub> = 25°C*
Max peak reverse current	I <sub>RM</sub> 25 μA	V <sub>R</sub> = 1600V, T <sub>J</sub> = 25°C
Max peak reverse current	I <sub>RM</sub> 2.0 mA	V <sub>R</sub> = 1600V, T <sub>J</sub> = 150°C
Max Recommended Operating Frequency	10kHz	

\*Pulse test: Pulse width 300 μsec. Duty cycle 2%

## Thermal and Mechanical Characteristics

Storage temperature range	T <sub>STG</sub>	-65°C to 200°C
Operating junction temp range	T <sub>J</sub>	-65°C to 200°C
Maximum thermal resistance	R <sub>θJC</sub>	0.6°C/W junction to case
Typical thermal resistance (greased)	R <sub>θCS</sub>	0.5°C/W case to sink
Mounting torque		25-30 inch pounds
Weight		.6 ounces (17 grams) typical



6 Lake Street  
Lawrence, MA 01841  
PH: (978) 620-2600  
FAX: (978) 689-0803  
www.microsemi.com

05-02-07 Rev. 3

# S/R37

Figure 1  
Typical Forward Characteristics

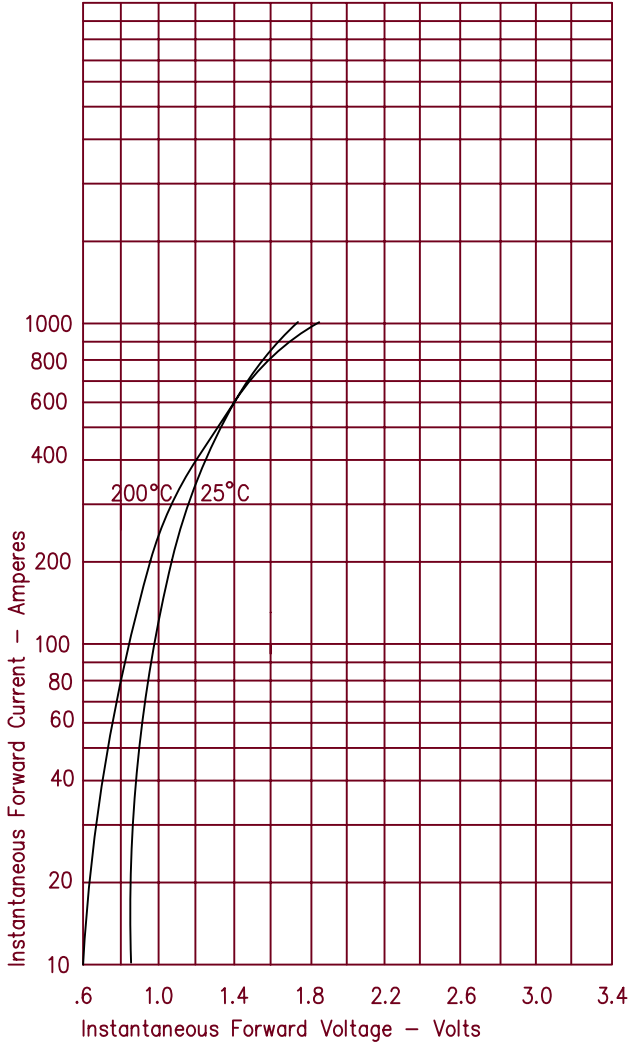

Figure 3  
Forward Current Derating

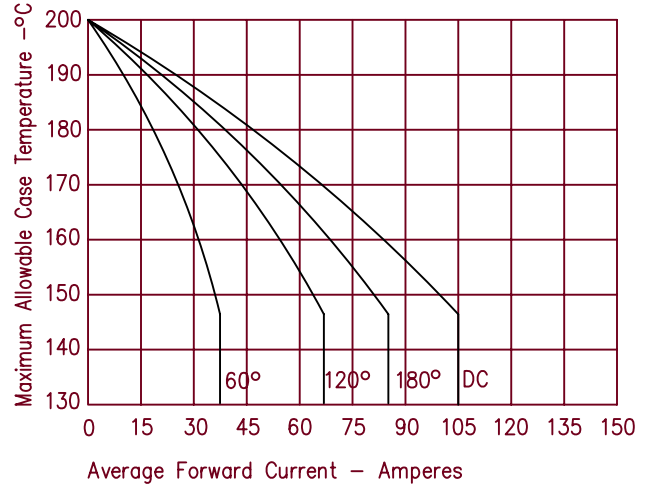

Figure 4  
Maximum Forward Power Dissipation

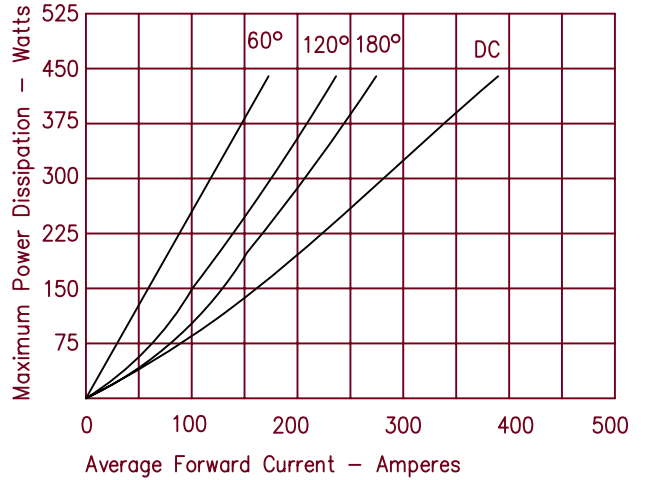

Figure 2  
Typical Reverse Characteristics

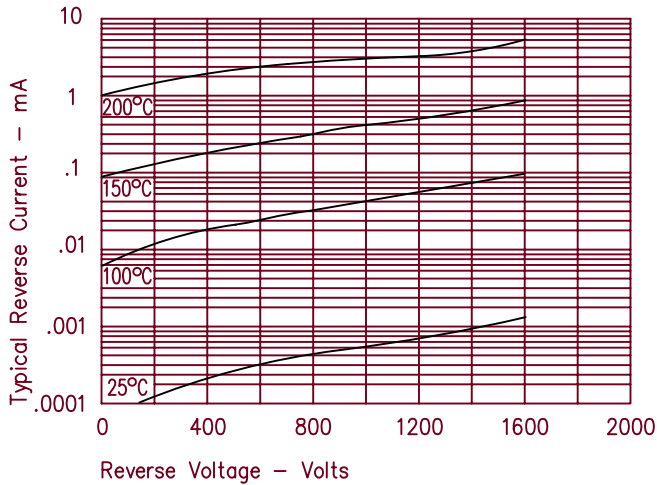
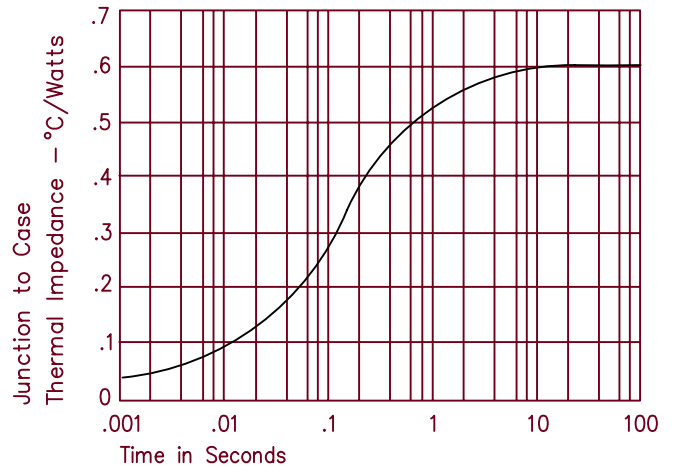



Figure 5  
Transient Thermal Impedance



## Looking for pricing, stock, or lifecycle information?

Click below to explore more details on WIN SOURCE:

-  [View S3740 on WIN SOURCE](#)
-  [Microchip Technology](#) Information

## Optimize Your Supply Chain with WIN SOURCE Solutions

-  Global Sourcing Solution
-  Obsolete Management
-  Cost Control Management
-  Shortage Management
-  Alternative Solution
-  Excess Inventory Management