



THE DATASHEET OF SBR2545



25 Amp Schottky Rectifier

SBR2535 — SBR2545

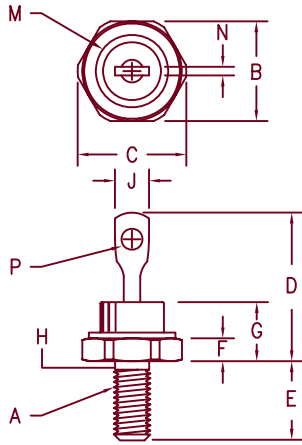

- Notes:
1. 10-32 UNF3A threads
 2. Full threads within 2 1/2 threads
 3. Standard Polarity: Stud is Cathode
Reverse Polarity: Stud is Anode

Dim.	Inches		Millimeter		Notes
	Minimum	Maximum	Minimum	Maximum	
A	---	---	---	---	1
B	.424	.437	10.77	11.10	
C	---	.505	---	12.82	
D	.600	.800	15.24	20.32	
E	.422	.453	10.72	11.50	
F	.075	.175	1.91	4.44	
G	---	.405	---	10.29	
H	.163	.189	4.15	4.80	2
J	---	.310	---	7.87	
M	---	.350	---	8.89	Dia.
N	.020	.065	.510	1.65	
P	.060	.100	1.53	2.54	Dia.

D0203AA (D04)

Microsemi Catalog Number	Industry Part Number	Working Peak Reverse Voltage	Repetitive Peak Reverse Voltage
SBR2535*	20FQ035	35V	35V
SBR2540*	20FQ040	40V	40V
SBR2545*	20FQ045	45V	45V

*Add the Suffix R for Reverse Polarity

- Schottky Barrier Rectifier
- Guard Ring Protection
- Low Forward Voltage
- VRRM – 35 to 45V
- 25 Amperes
- Reverse Energy Tested

Electrical Characteristics

Average forward current	$I_{F(AV)}$ 25 Amps	$T_C = 105^\circ\text{C}$, Square wave, $R_{\theta JC} = 1.6^\circ\text{C/W}$
Average forward current	$I_{F(AV)}$ 30 Amps	$T_C = 97^\circ\text{C}$, Square wave, $R_{\theta JC} = 1.6^\circ\text{C/W}$
Maximum surge current	I_{FSM} 600 Amps	8.3 ms, half sine $T_J = 150^\circ\text{C}$
Max repetitive peak reverse current	$I_{R(OV)}$ 2 Amps	$f = 1 \text{ KHz}$, 25°C , $1 \mu\text{sec}$ Square wave
Max peak forward voltage	V_{FM} .53 Volts	$I_{FM} = 25\text{A}$: $T_J = 150^\circ\text{C}^*$
Max peak forward voltage	V_{FM} .58 Volts	$I_{FM} = 25\text{A}$: $T_J = 25^\circ\text{C}^*$
Max peak reverse current	I_{RM} 250 mA	V_{RRM} , $T_J = 125^\circ\text{C}^*$
Max peak reverse current	I_{RM} 2 mA	V_{RRM} , $T_J = 25^\circ\text{C}$
Typical junction capacitance	C_J 1200 pF	$V_R = 5.0\text{V}$, $T_J = 25^\circ\text{C}$

*Pulse test: Pulse width 300 μsec , Duty cycle 2%

Thermal and Mechanical Characteristics

Storage temp range	TSTG	-55°C to 175°C
Operating junction temp range	T_J	-55°C to 150°C
Max thermal resistance	$R_{\theta JC}$	1.6°C/W Junction to case
Typical thermal resistance (greased)	$R_{\theta CS}$	0.5°C/W Case to sink
Mounting torque		12-15 inch pounds
Weight		0.2 ounces (6.0 grams) typical



6 Lake Street
Lawrence, MA 01841
PH: (978) 620-2600
FAX: (978) 689-0803
www.microsemi.com

05-25-07 Rev. 3

SBR2535 — SBR2545

Figure 1
Typical Forward Characteristics

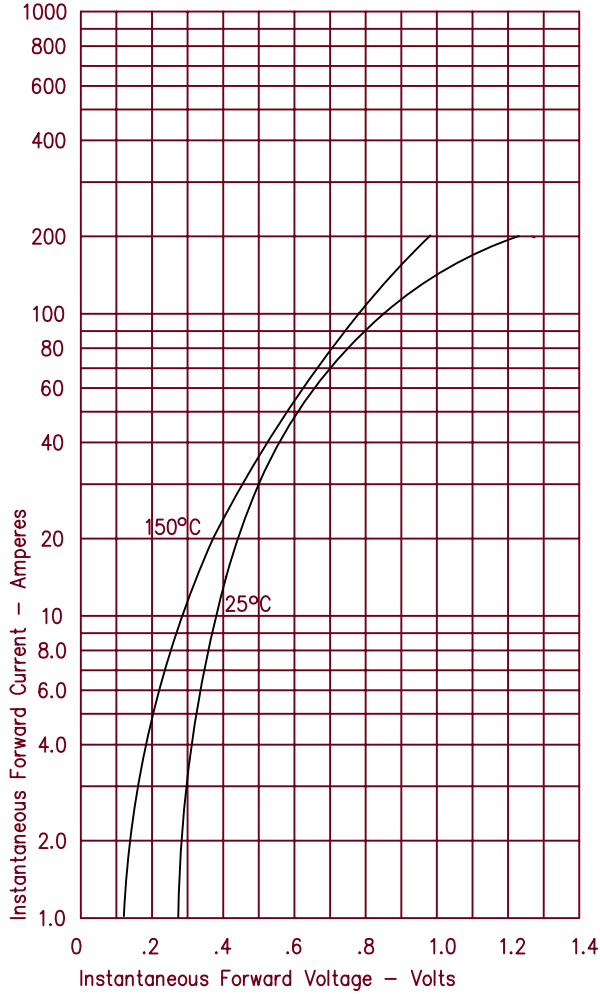

Figure 3
Typical Junction Capacitance

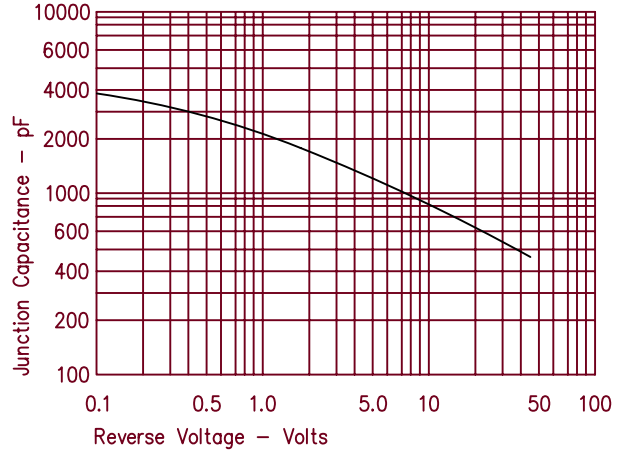

Figure 4
Forward Current Derating

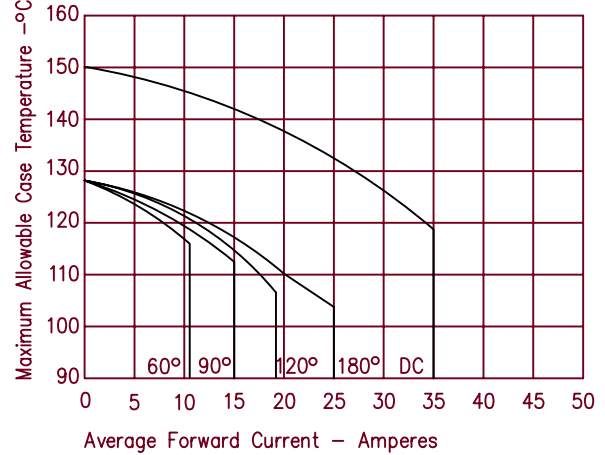

Figure 2
Typical Reverse Characteristics

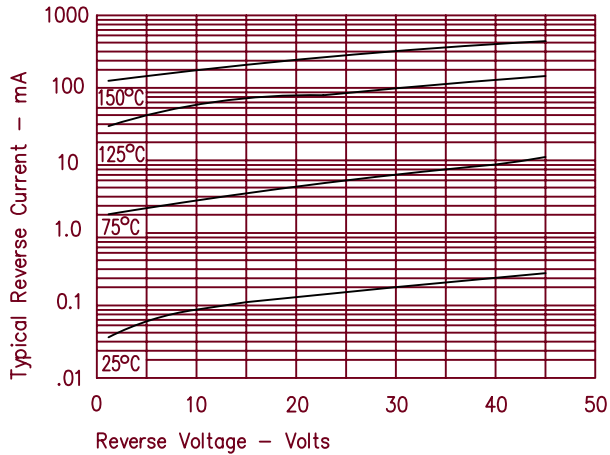
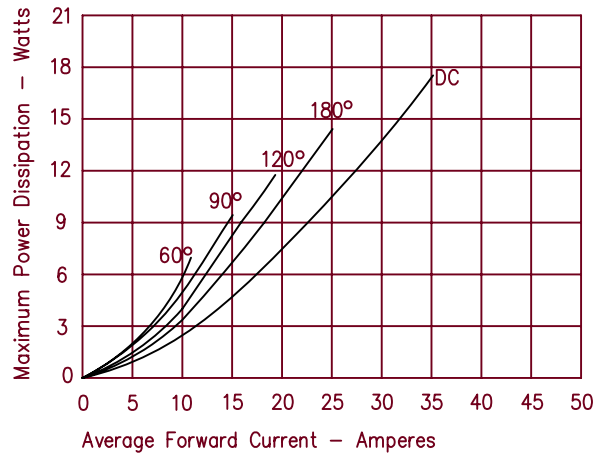



Figure 5
Maximum Forward Power Dissipation



Looking for pricing, stock, or lifecycle information?

Click below to explore more details on WIN SOURCE:

-  [View SBR2545 on WIN SOURCE](#)
-  [Microchip Technology](#) Information

Optimize Your Supply Chain with WIN SOURCE Solutions

-  Global Sourcing Solution
-  Obsolete Management
-  Cost Control Management
-  Shortage Management
-  Alternative Solution
-  Excess Inventory Management