



THE DATASHEET OF SBR3040



30 Amp Schottky Rectifier

SBR3035 — SBR3050

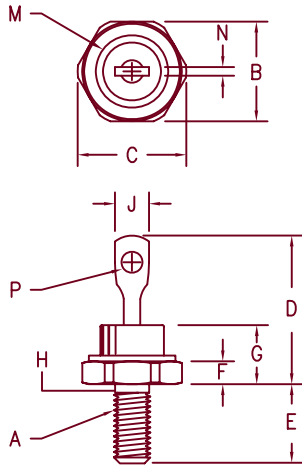

- Notes:
1. 10-32 UNF3A threads
 2. Full threads within 2 1/2 threads
 3. Standard Polarity:
Stud is Cathode. Reverse Polarity Stud is Anode

Dim.	Inches		Millimeter		Notes
	Minimum	Maximum	Minimum	Maximum	
A	---	---	---	---	1
B	.424	.437	10.77	11.10	
C	---	.505	---	12.82	
D	.600	.800	15.24	20.32	
E	.422	.453	10.72	11.50	
F	.075	.175	1.91	4.44	
G	---	.405	---	10.29	
H	.163	.189	4.15	4.80	2
J	---	.250	2.54	3.56	
M	---	.350	---	8.89	Dia.
N	.020	.065	.510	1.65	
P	.070	.100	1.78	2.54	Dia.

D0203AA (D04)

Microsemi Catalog Number	Industry Part Number	Working Peak Reverse Voltage	Repetitive Peak Reverse Voltage
SBR3035*	21FQ035 30FQ035	35V	35V
SBR3040*	21FQ040 30FQ040	40V	40V
SBR3045*	21FQ045 30FQ045	45V	45V
SBR3050*		50V	50V

*Add Suffix R For Reverse Polarity

- Schottky Barrier Rectifier
- Guard Ring Protection
- Low Forward Voltage
- VRRM 35 to 50V
- 30 Amperes
- Reverse Energy Tested

Electrical Characteristics

Average forward current	I _{F(AV)} 30 Amps	T _C = 145°C Square wave, R _{θJC} = 1.5°C/W
Maximum surge current	I _{FSM} 600 Amps	8.3 ms, half sine T _J = 175°C
Max repetitive peak reverse current	I _{R(OV)} 2 Amps	f = 1 KHz, 25°C, 1 μsec Square wave
Max peak forward voltage	V _{FM} .49 Volts	I _{FM} = 30A: T _J = 175°C*
Max peak forward voltage	V _{FM} .63 Volts	I _{FM} = 30A: T _J = 25°C*
Max peak reverse current	I _{RM} 25 mA	V _R = 5.0V, T _J = 125°C*
Max peak reverse current	I _{RM} 1.5 mA	V _{RRM} , T _J = 25°C
Typical junction capacitance	C _J 1800 pF	

*Pulse test: Pulse width 300 μsec, Duty cycle 2%

Thermal and Mechanical Characteristics

Storage temp range	T _{STG}	-55°C to 175°C
Operating junction temp range	T _J	-55°C to 175°C
Max thermal resistance	R _{θJC}	1.5°C/W Junction to case
Typical thermal resistance (greased)	R _{θCS}	0.5°C/W Case to sink
Mounting torque		12-15 inch pounds
Weight		0.2 ounces (6.0 grams) typical



6 Lake Street
Lawrence, MA 01841
PH: (978) 620-2600
FAX: (978) 689-0803
www.microsemi.com

05-25-07 Rev. 3

SBR3035 — SBR3050

Figure 1
Typical Forward Characteristics

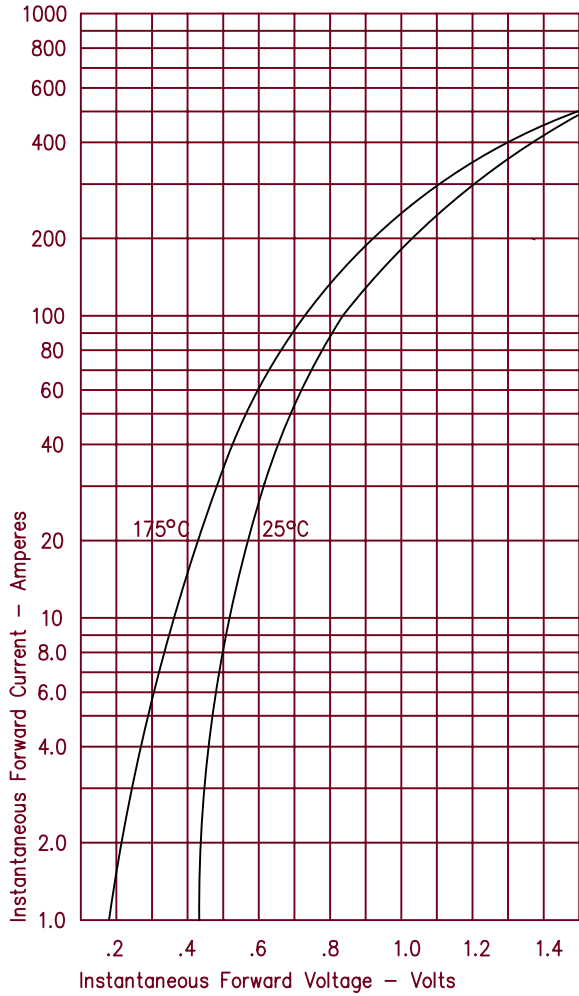

Figure 3
Typical Junction Capacitance

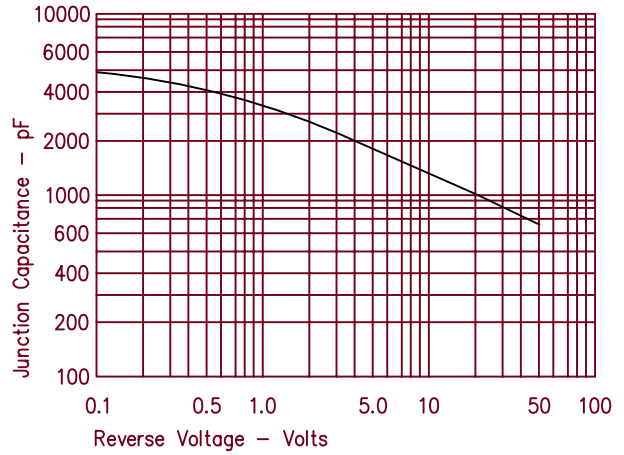

Figure 4
Forward Current Derating

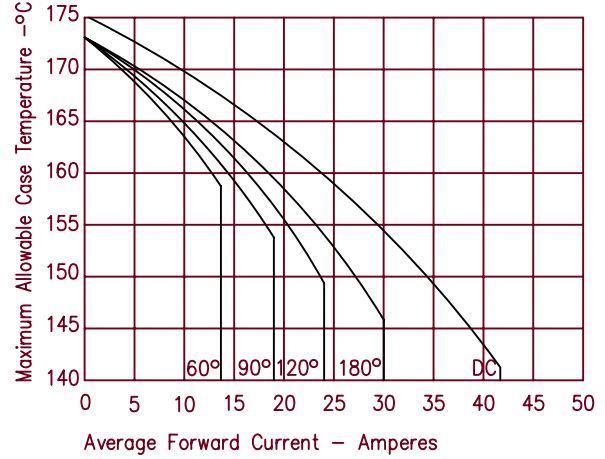

Figure 2
Typical Reverse Characteristics

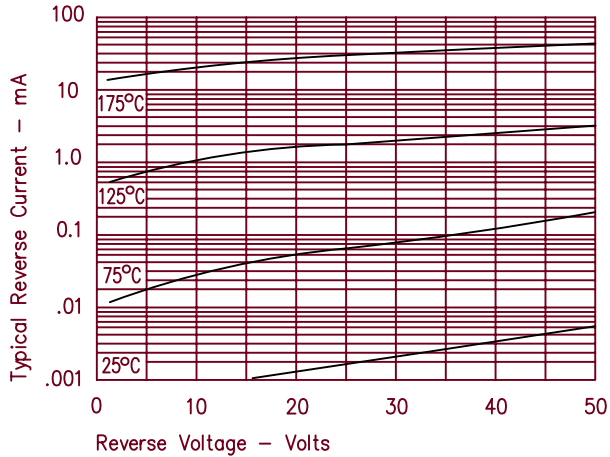
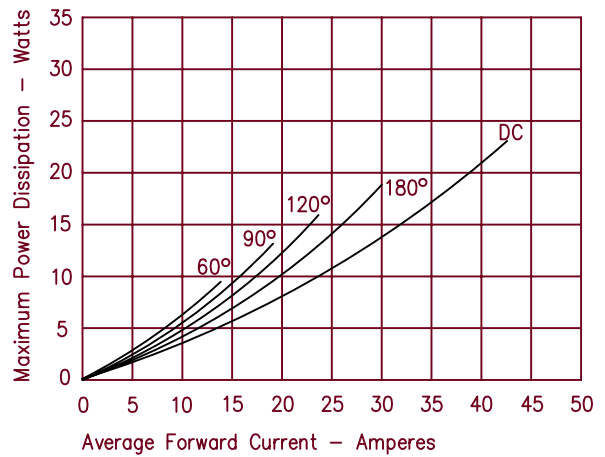



Figure 5
Maximum Forward Power Dissipation



Looking for pricing, stock, or lifecycle information?

Click below to explore more details on WIN SOURCE:

-  [View SBR3040 on WIN SOURCE](#)
-  [Microchip Technology](#) Information

Optimize Your Supply Chain with WIN SOURCE Solutions

-  Global Sourcing Solution
-  Obsolete Management
-  Cost Control Management
-  Shortage Management
-  Alternative Solution
-  Excess Inventory Management