

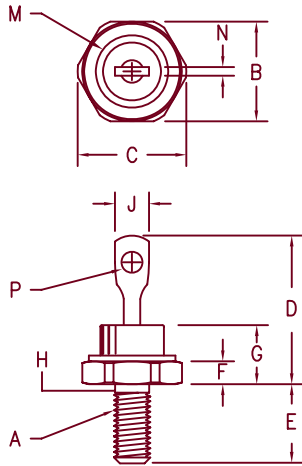

# THE DATASHEET OF SBR3060



# 30 Amp Schottky Rectifier SBR3060



- Notes:
- 10-32 UNF3A threads
  - Full threads within 2 1/2 threads
  - Standard Polarity:  
Stud is Cathode. Reverse Polarity Stud is Anode

Dim.	Inches		Millimeter		Notes
	Minimum	Maximum	Minimum	Maximum	
A	---	---	---	---	1
B	.424	.437	10.77	11.10	
C	---	.505	---	12.82	
D	.600	.800	15.24	20.32	
E	.422	.453	10.72	11.50	
F	.075	.175	1.91	4.44	
G	---	.405	---	10.29	
H	.163	.189	4.15	4.80	2
J	---	.250	2.54	3.56	
M	---	.350	---	8.89	Dia.
N	.020	.065	.510	1.65	
P	.070	.100	1.78	2.54	Dia.

D0203AA (D04)

Microsemi Catalog Number	Working Peak Reverse Voltage	Repetitive Peak Reverse Voltage
SBR3060*	60V	60V

\*Add Suffix R For Reverse Polarity

- Schottky Barrier Rectifier
- Guard Ring Protection
- Low Forward Voltage
- $V_{RRM}$  60V
- 30 Amperes
- Reverse Energy Tested

## Electrical Characteristics

Average forward current	$I_F(AV)$ 30 Amps	$T_C = 146^\circ C$ Square wave, $R_{\theta JC} = 1.5^\circ C/W$
Maximum surge current	$I_{FSM}$ 600 Amps	8.3 ms, half sine $T_J = 175^\circ C$
Max repetitive peak reverse current	$I_R(OV)$ 2 Amps	$f = 1$ KHz, $25^\circ C$ , 1 $\mu sec$ Square wave
Max peak forward voltage	$V_{FM}$ .68 Volts	$I_{FM} = 30A$ : $T_J = 25^\circ C^*$
Max peak reverse current	$I_{RM}$ 25 mA	$V_{RRM}$ , $T_J = 125^\circ C^*$
Max peak reverse current	$I_{RM}$ 1.5 mA	$V_{RRM}$ , $T_J = 25^\circ C$
Typical junction capacitance	$C_J$ 1500 pF	$V_R = 5.0V$ , $T_J = 25^\circ C$

\*Pulse test: Pulse width 300  $\mu sec$ , Duty cycle 2%

## Thermal and Mechanical Characteristics

Storage temp range	$T_{STG}$	$-55^\circ C$ to $175^\circ C$
Operating junction temp range	$T_J$	$-55^\circ C$ to $175^\circ C$
Max thermal resistance	$R_{\theta JC}$	$1.5^\circ C/W$ Junction to case
Typical thermal resistance (greased)	$R_{\theta CS}$	$0.5^\circ C/W$ Case to sink
Mounting torque		12-15 inch pounds
Weight		0.2 ounces (6.0 grams) typical



6 Lake Street  
Lawrence, MA 01841  
PH: (978) 620-2600  
FAX: (978) 689-0803  
www.microsemi.com

05-25-07 Rev. 2

# SBR3060

Figure 1  
Typical Forward Characteristics

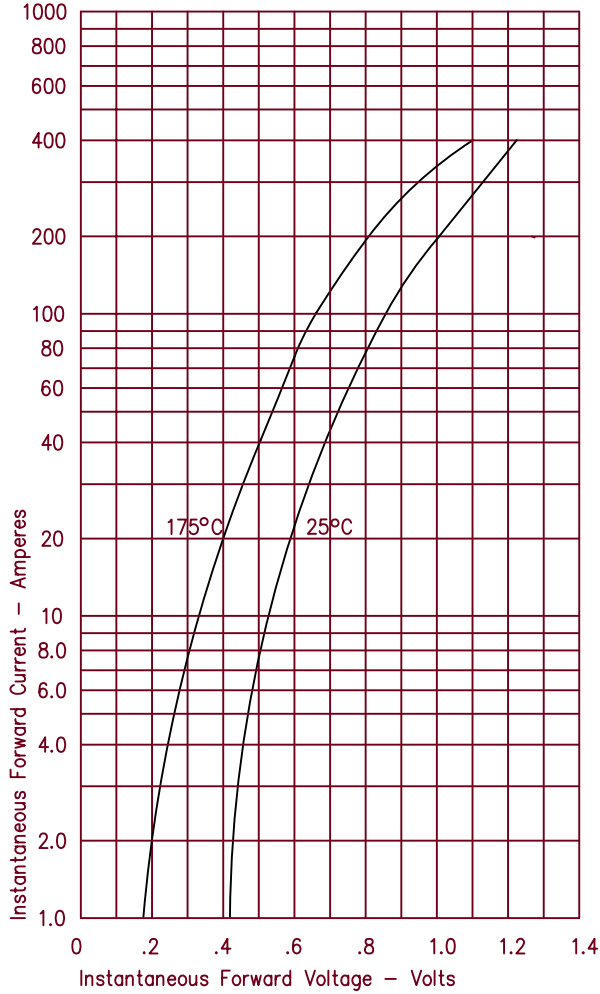

Figure 3  
Typical Junction Capacitance

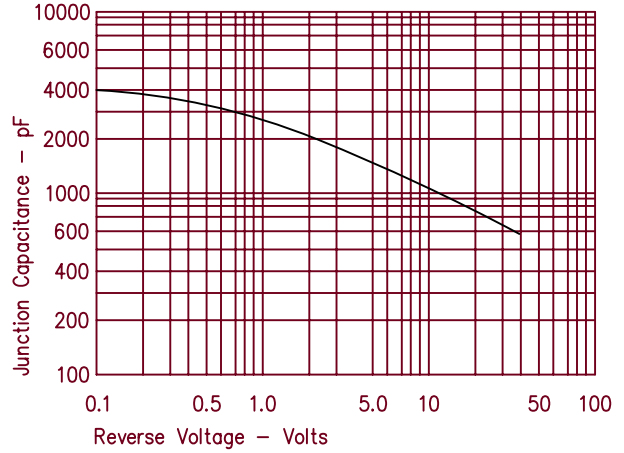

Figure 4  
Forward Current Derating

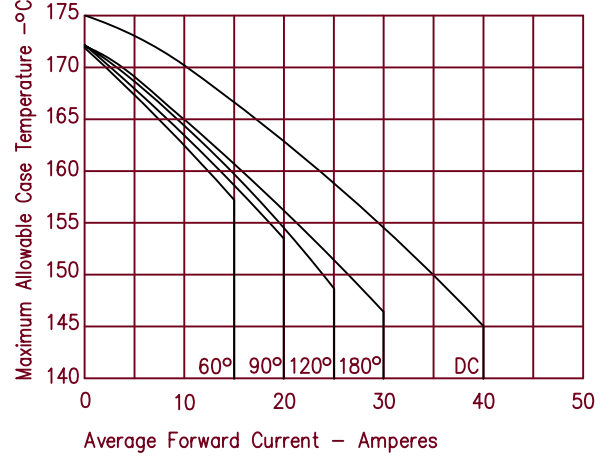

Figure 2  
Typical Reverse Characteristics

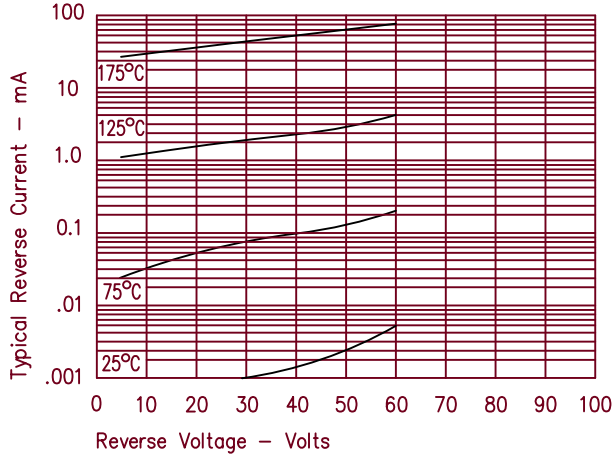
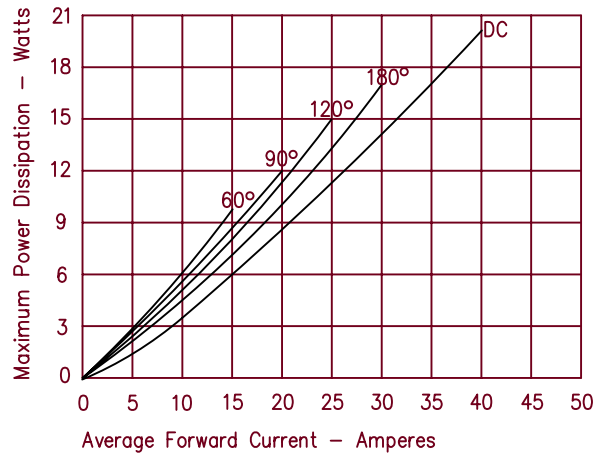



Figure 5  
Maximum Forward Power Dissipation



## Looking for pricing, stock, or lifecycle information?

Click below to explore more details on WIN SOURCE:

-  [View SBR3060 on WIN SOURCE](#)
-  [Microchip Technology](#) Information

## Optimize Your Supply Chain with WIN SOURCE Solutions

-  Global Sourcing Solution
-  Obsolete Management
-  Cost Control Management
-  Shortage Management
-  Alternative Solution
-  Excess Inventory Management