

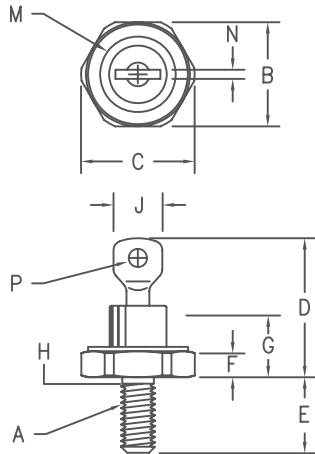

THE DATASHEET OF S2520



Silicon Power Rectifier S/R25 Series



Notes:

1. 10-32 UNF3A
2. Full threads within 2 1/2 threads
3. Standard Polarity: Stud is Cathode
Reverse Polarity: Stud is Anode

Dim.	Inches		Millimeter		Notes
	Minimum	Maximum	Minimum	Maximum	
A	---	---	---	---	1
B	.424	.437	10.77	11.10	
C	---	.505	---	12.82	
D	.600	.800	15.24	20.32	
E	.422	.453	10.72	11.50	
F	.075	.175	1.91	4.44	
G	---	.405	---	10.29	
H	.163	.189	4.15	4.80	2
J	---	.310	---	7.87	
M	---	.350	---	8.89	Dia
N	.020	.065	.510	1.65	
P	.070	.100	1.78	2.54	Dia

Microsemi Catalog Number		Peak Reverse Voltage
	1N1199C	1N3615 50V
	1N1200C	1N3616 100V
	1N1201C	1N3617 150V
*S2520	1N1202C	1N3618 200V
	1N1203C	1N3619 300V
*S2540	1N1204C	1N3620 400V
	1N1205C	1N3621 500V
*S2560	1N1206C	1N3622 600V
*S2580		1N3623 800V
*S25100		1N3624 1000V
*S25120		1200V
*S25140		1400V
*S25160		1600V

*Change S to R in part number for Reverse Polarity
For 1N types, add R suffix for Reverse Polarity

DO203AA (DO4)

- Glass Passivated Die
- Low Forward Voltage
- 400A Surge Rating
- Glass to metal seal construction
- V_{RRM} to 1600V
- Excellent reliability
- Low cost Non-RoHS package

Electrical Characteristics

Average forward current	$I_F(AV)$ 25 Amps	$T_C = 135^\circ C$, half sine wave, $R_{\theta JC} = 2.0^\circ C/W$
Maximum surge current	I_{FSM} 400 Amps	8.3ms, half sine, $T_J = 200^\circ C$
Max $I^2 t$ for fusing	$I^2 t$ 660 $A^2 s$	
Max peak forward voltage	V_{FM} 1.1 Volts	$I_{FM} = 30A; T_J = 25^\circ C$ *
Max peak reverse current	I_{RM} 10 μA	$V_{RRM}, T_J = 25^\circ C$
Max peak reverse current	I_{RM} 1.0 mA	$V_{RRM}, T_J = 150^\circ C$
Max Recommended Operating Frequency	10kHz	

*Pulse test: Pulse width 300 μsec . Duty cycle 2%

Thermal and Mechanical Characteristics

Storage temperature range	T_{STG}	$-65^\circ C$ to $200^\circ C$
Operating junction temp range	T_J	$-65^\circ C$ to $200^\circ C$
Maximum thermal resistance	$R_{\theta JC}$	$2.0^\circ C/W$ Junction to Case
Mounting torque		25-30 inch pounds
Weight		.16 ounces (5.0 grams) typical

S/R25

Figure 1
Maximum Forward Characteristics

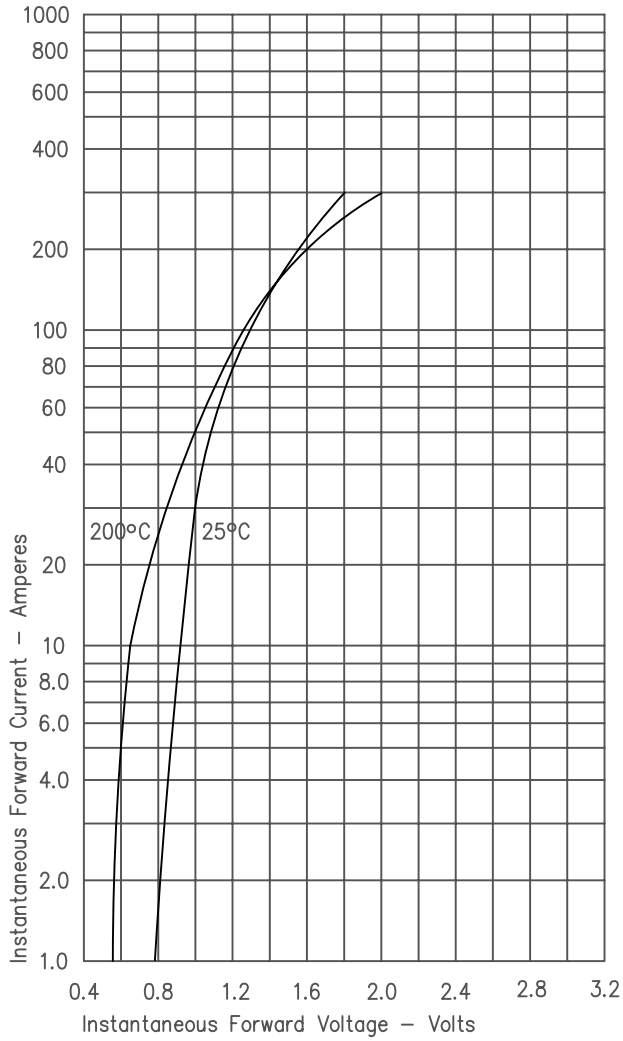

Figure 3
Forward Current Derating

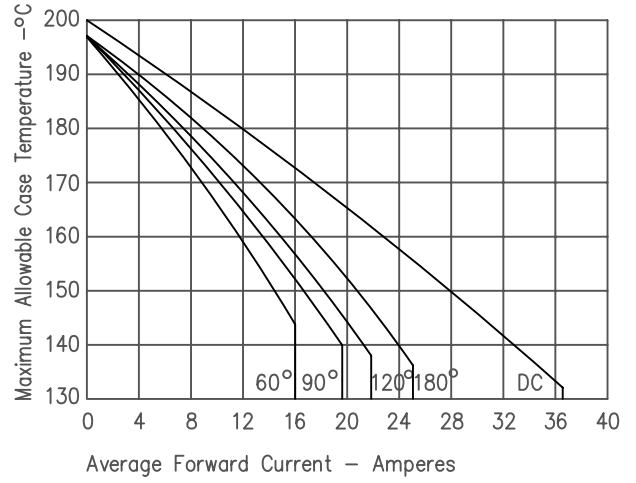

Figure 4
Maximum Forward Power Dissipation

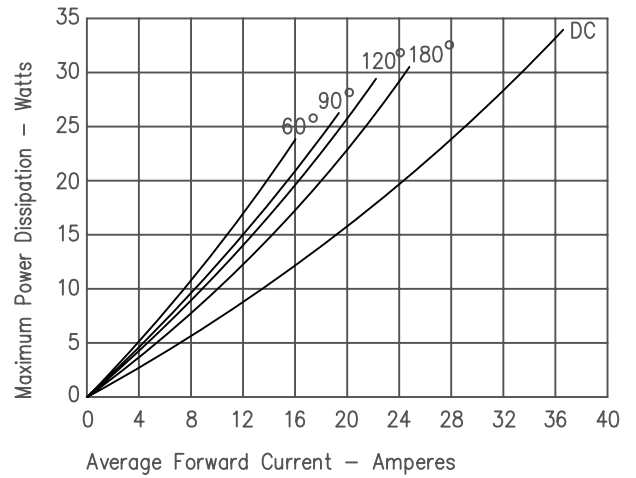
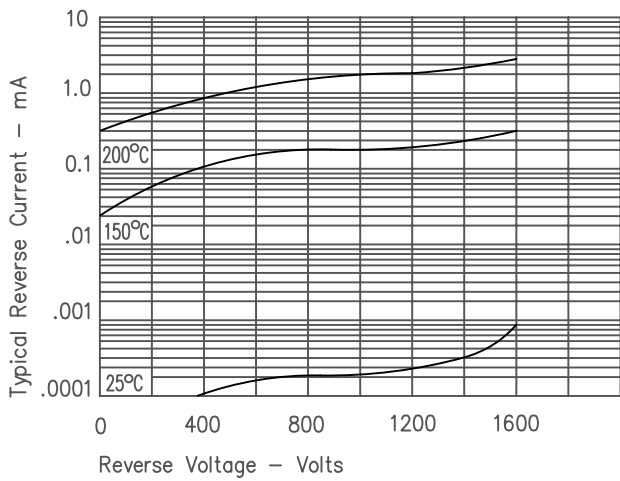



Figure 2
Typical Reverse Characteristics



Looking for pricing, stock, or lifecycle information?

Click below to explore more details on WIN SOURCE:

-  [View S2520 on WIN SOURCE](#)
-  [Microchip Technology](#) Information

Optimize Your Supply Chain with WIN SOURCE Solutions

-  Global Sourcing Solution
-  Obsolete Management
-  Cost Control Management
-  Shortage Management
-  Alternative Solution
-  Excess Inventory Management