



**THE DATASHEET OF  
SB2K-M3/52T**





## Surface-Mount Glass Passivated Rectifier

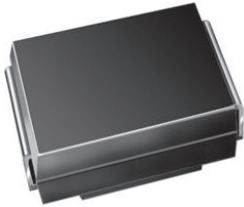

SMB (DO-214AA)



### FEATURES

- Low profile package
- Ideal for automated placement
- Glass passivated chip junction
- Low forward voltage drop
- Low leakage current
- High forward surge capability
- Meets MSL level 1, per J-STD-020, LF maximum peak of 260 °C
- Material categorization: for definitions of compliance please see [www.vishay.com/doc?99912](http://www.vishay.com/doc?99912)



**RoHS**  
COMPLIANT  
HALOGEN  
**FREE**

### ADDITIONAL RESOURCES



3D Models

### TYPICAL APPLICATIONS

For use in general purpose rectification of power supplies, inverters, converters and freewheeling diodes for consumer and telecommunication.

### MECHANICAL DATA

**Case:** SMB (DO-214AA)

Molding compound meets UL 94 V-0 flammability rating  
Base P/N-M3 - halogen-free, RoHS compliant, and commercial grade

**Terminals:** matte tin plated leads, solderable per J-STD-002 and JESD 22-B102

M3 suffix meets JESD 201 class 1A whisker test

**Polarity:** color band denotes the cathode end

PRIMARY CHARACTERISTICS	
$I_{F(AV)}$	2.0 A
$V_{RRM}$	200 V, 400 V, 600 V, 800 V, 1000 V
$I_{FSM}$	55 A
$I_R$	1.0 $\mu$ A
$V_F$ at $I_F = 2.0$ A	0.86 V
$T_J$ max.	150 °C
Package	SMB (DO-214AA)
Circuit configuration	Single

MAXIMUM RATINGS ( $T_A = 25$ °C unless otherwise noted)							
PARAMETER	SYMBOL	SB2D	SB2G	SB2J	SB2K	SB2M	UNIT
Device marking code		B2D	B2G	B2J	B2K	B2M	
Maximum repetitive peak reverse voltage	$V_{RRM}$	200	400	600	800	1000	V
Maximum DC forward current (fig. 1)	$I_F^{(1)}$	2.0					A
Peak forward surge current 8.3 ms single half sine-wave superimposed on rated load	$I_{FSM}$	55					A
Operating and storage temperature range	$T_J, T_{STG}$	-55 to +150					°C

#### Note

(1) Mounted on 8 mm x 8 mm pad areas, 1 oz. FR4 PCB



<b>ELECTRICAL CHARACTERISTICS</b> ( $T_A = 25\text{ }^\circ\text{C}$ unless otherwise noted)						
PARAMETER	TEST CONDITIONS		SYMBOL	TYP.	MAX.	UNIT
Instantaneous forward voltage	$I_F = 1.0\text{ A}$	$T_A = 25\text{ }^\circ\text{C}$	$V_F^{(1)}$	0.90	-	V
	$I_F = 2.0\text{ A}$			0.96	1.15	
	$I_F = 1.0\text{ A}$	$T_A = 125\text{ }^\circ\text{C}$		0.78	-	
	$I_F = 2.0\text{ A}$			0.86	1.05	
Reverse current	Rated $V_R$	$T_A = 25\text{ }^\circ\text{C}$	$I_R^{(2)}$	0.15	1.0	$\mu\text{A}$
		$T_A = 125\text{ }^\circ\text{C}$		36	125	
Typical reverse recovery time	$I_F = 0.5\text{ A}$ , $I_R = 1.0\text{ A}$ , $I_{rr} = 0.25\text{ A}$		$t_{rr}$	2.0		$\mu\text{s}$
Typical junction capacitance	Rated $V_R = 4.0\text{ V}$ , 1 MHz		$C_J$	16		pF

**Notes**

- (1) Pulse test: 300  $\mu\text{s}$  pulse width, 1 % duty cycle
- (2) Pulse test: Pulse width,  $\leq 40\text{ ms}$

<b>THERMAL CHARACTERISTICS</b> ( $T_A = 25\text{ }^\circ\text{C}$ unless otherwise noted)							
PARAMETER	SYMBOL	SB2D	SB2G	SB2J	SB2K	SB2M	UNIT
Typical thermal resistance	$R_{\theta JA}^{(1)}$	70					$^\circ\text{C/W}$
	$R_{\theta JM}^{(1)}$	10					

**Note**

- (1) Units mounted on PCB with 8.0 mm x 8.0 mm copper pad areas, 1 oz. FR4 PCB;  $R_{\theta JA}$  - junction-to-ambient  $R_{\theta JM}$  - junction-to-mount

<b>ORDERING INFORMATION</b> (Example)				
PREFERRED P/N	UNIT WEIGHT (g)	PREFERRED PACKAGE CODE	BASE QUANTITY	DELIVERY MODE
SB2J-M3/52T	0.096	52T	750	7" diameter plastic tape and reel
SB2J-M3/5BT	0.096	5BT	3200	13" diameter plastic tape and reel

**RATINGS AND CHARACTERISTICS CURVES** ( $T_A = 25\text{ }^\circ\text{C}$  unless otherwise noted)

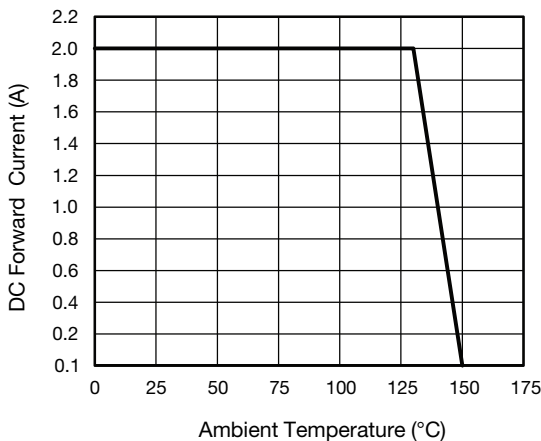

Fig. 1 - Maximum Forward Current Derating Curve

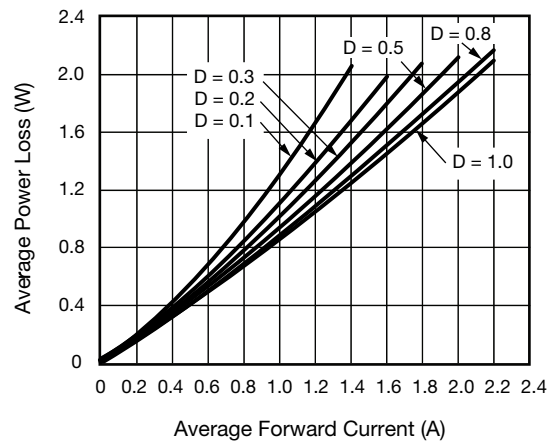

Fig. 2 - Forward Power Loss Characteristics

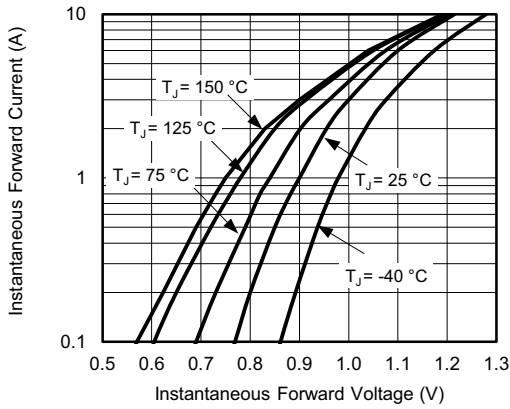

Fig. 3 - Typical Instantaneous Forward Characteristics

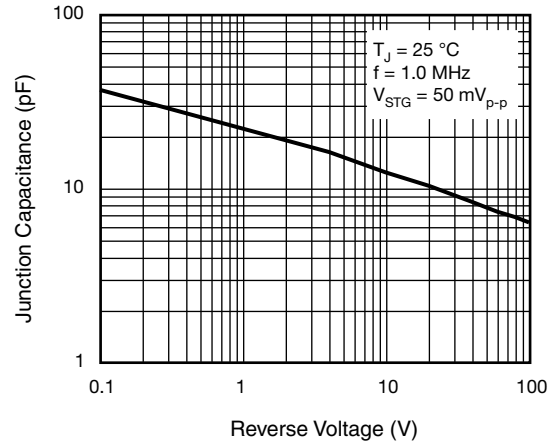

Fig. 5 - Typical Junction Capacitance

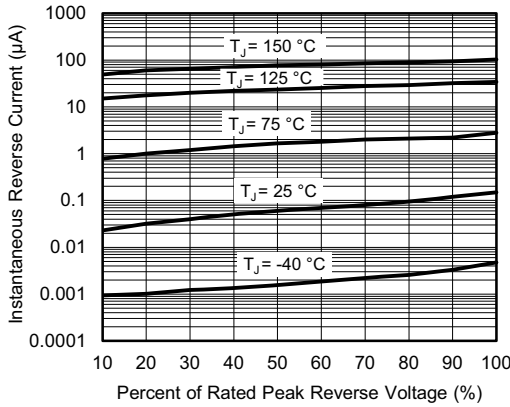

Fig. 4 - Typical Reverse Characteristics

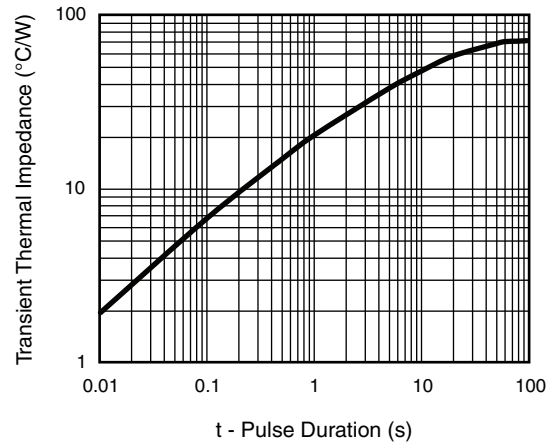
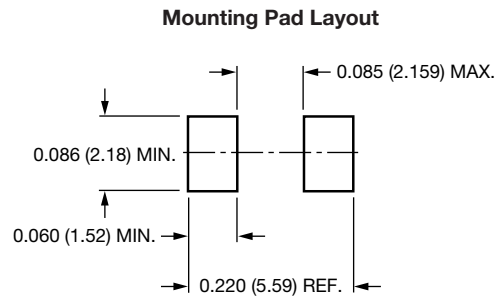
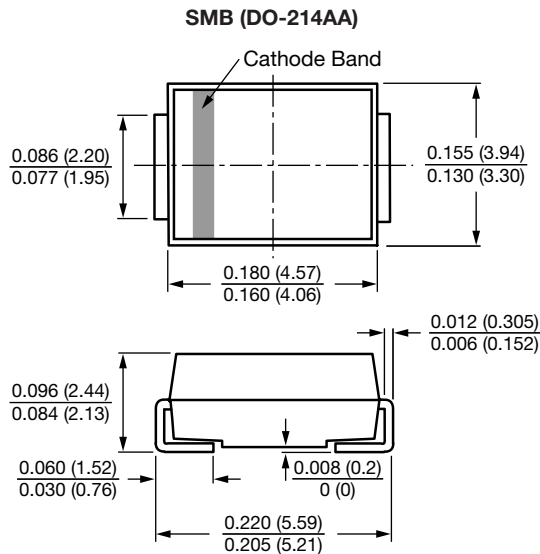

Fig. 6 - Typical Transient Thermal Impedance

**PACKAGE OUTLINE DIMENSIONS** in inches (millimeters)





## Disclaimer

ALL PRODUCT, PRODUCT SPECIFICATIONS AND DATA ARE SUBJECT TO CHANGE WITHOUT NOTICE TO IMPROVE RELIABILITY, FUNCTION OR DESIGN OR OTHERWISE.

Vishay Intertechnology, Inc., its affiliates, agents, and employees, and all persons acting on its or their behalf (collectively, "Vishay"), disclaim any and all liability for any errors, inaccuracies or incompleteness contained in any datasheet or in any other disclosure relating to any product.

Vishay makes no warranty, representation or guarantee regarding the suitability of the products for any particular purpose or the continuing production of any product. To the maximum extent permitted by applicable law, Vishay disclaims (i) any and all liability arising out of the application or use of any product, (ii) any and all liability, including without limitation special, consequential or incidental damages, and (iii) any and all implied warranties, including warranties of fitness for particular purpose, non-infringement and merchantability.

Statements regarding the suitability of products for certain types of applications are based on Vishay's knowledge of typical requirements that are often placed on Vishay products in generic applications. Such statements are not binding statements about the suitability of products for a particular application. It is the customer's responsibility to validate that a particular product with the properties described in the product specification is suitable for use in a particular application. Parameters provided in datasheets and / or specifications may vary in different applications and performance may vary over time. All operating parameters, including typical parameters, must be validated for each customer application by the customer's technical experts. Product specifications do not expand or otherwise modify Vishay's terms and conditions of purchase, including but not limited to the warranty expressed therein.

Hyperlinks included in this datasheet may direct users to third-party websites. These links are provided as a convenience and for informational purposes only. Inclusion of these hyperlinks does not constitute an endorsement or an approval by Vishay of any of the products, services or opinions of the corporation, organization or individual associated with the third-party website. Vishay disclaims any and all liability and bears no responsibility for the accuracy, legality or content of the third-party website or for that of subsequent links.

Except as expressly indicated in writing, Vishay products are not designed for use in medical, life-saving, or life-sustaining applications or for any other application in which the failure of the Vishay product could result in personal injury or death. Customers using or selling Vishay products not expressly indicated for use in such applications do so at their own risk. Please contact authorized Vishay personnel to obtain written terms and conditions regarding products designed for such applications.

No license, express or implied, by estoppel or otherwise, to any intellectual property rights is granted by this document or by any conduct of Vishay. Product names and markings noted herein may be trademarks of their respective owners.

## Looking for pricing, stock, or lifecycle information?

Click below to explore more details on WIN SOURCE:

- ⊖ [View SB2K-M3/52T on WIN SOURCE](#)
- ⊖ [Vishay Information](#)

## Optimize Your Supply Chain with WIN SOURCE Solutions

- ✓ Global Sourcing Solution
- ✓ Obsolete Management
- ✓ Cost Control Management
- ✓ Shortage Management
- ✓ Alternative Solution
- ✓ Excess Inventory Management