



**THE DATASHEET OF
SMSA7630-061**



DATA SHEET

SMSA7630-061: Surface-Mount, 0201 Zero-Bias Silicon Schottky Detector Diode

Automotive Applications

- In-vehicle Wi-Fi @ 2.4 GHz and 5.0 GHz
- Infotainment
- Navigation
- Garage door openers
- Wireless control systems
- Telematics



Features

- AEC-Q101 qualified
- Excellent sensitivity
- Suitable for use up to 77 GHz
- Low parasitic impedance: $C_p < 0.05$ pF, $L_s < 0.2$ nH
- Low profile, ultra-miniature 0201 SMT package (MSL1, 260 °C per JEDEC J-STD-020)

Description

The SMSA7630-061 is a silicon, zero-bias Schottky detector diode with an ultra-miniature 0201 footprint and very low barrier height. This P-type diode can be used for sensitive video detector circuits and sampling circuits.

The low barrier height results in good detector sensitivity without the need for external bias current. The low junction capacitance of this diode makes it an excellent detector at frequencies up to 77 GHz and higher.

A pinout diagram for the SMSA7630-061 is shown in Figure 1.



Skyworks Green™ products are compliant with all applicable legislation and are halogen-free. For additional information, refer to *Skyworks Definition of Green™*, document number SQ04-0074.

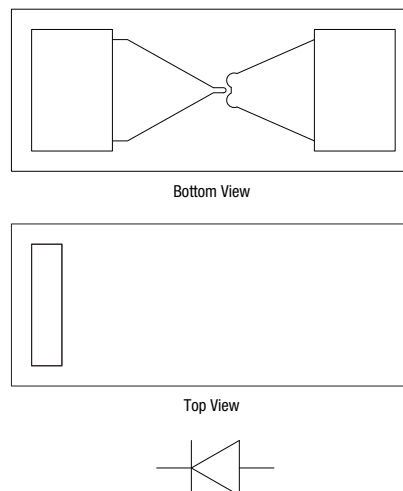

Figure 1. SMSA7630-061 Pinout Diagram

Mixer and Detector Applications

24 GHz Detector Design

A detector circuit that incorporates an SMSA7630-061 Schottky diode and covers the 24 GHz band is shown in Figure 2. The RF arrives on a 50 Ω microstrip line from the left and is shorted to GND by a 90-degree line with a stud (GND arrives by a via).

The cathode of the diode is directly connected to a 24 GHz stub. This output is loaded by a 100 kΩ resistor and a 100 pF capacitor. The output voltage is fed to a 2-pin, 2.54 mm header.

The circuit was built on a 0.254 mm Rogers RO-4350B substrate and measured with a power-variable 24 GHz source. A layout design is illustrated in Figure 3.

Input power versus detected voltage for this detector is shown in Figure 8.

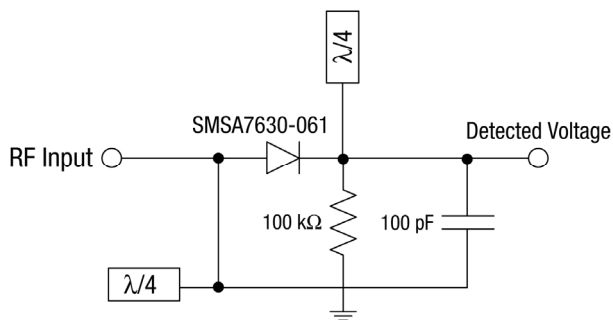

Figure 2. Schematic of a 24 GHz Detector Design

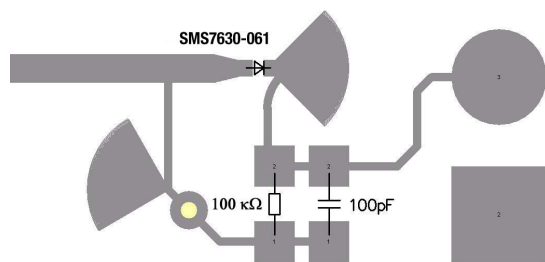

Figure 3. Layout for a 24 GHz Detector Design

24 GHz Rat-Race Mixer

A rat-race mixer that uses two SMSA7630-061 Schottky diodes is shown in Figure 4. The LO signal (24 GHz) is fed from the right side and reaches a rat-race ring. The diodes are positioned 90 degrees apart from the LO input and are terminated in a stub.

Both diodes are connected (using a 1206 resistor) and are loaded by a 470 Ω resistor and a 10 pF capacitor. This forms the IF output (10 MHz). The RF input (24.010 GHz) is directly connected to the rat-race ring. A layout design is illustrated in Figure 5.

The mixer has been tested with the following conditions:

- LO frequency: 24 GHz
- LO power: -4 to +6 dBm
- RF frequency: 24.010 GHz
- RF power: -30 dBm

Typical conversion loss data for this mixer is shown in Figure 9.

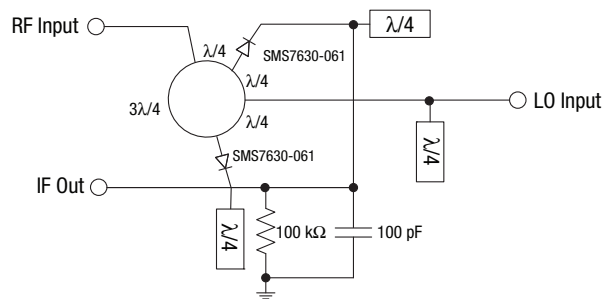

Figure 4. Schematic of a 24 GHz Rat-Race Mixer

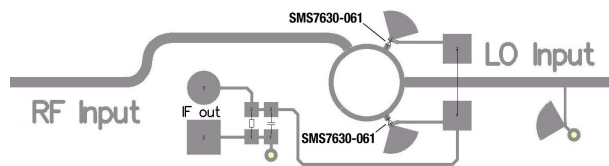

Figure 5. Layout for a 24 GHz Rat-Race Mixer

Electrical and Mechanical Specifications

The absolute maximum ratings of the SMSA7630-061 are provided in Table 1. Electrical specifications are provided in

Table 2. The associated SPICE model parameters are provided in Table 3.

Table 1. SMSA7630-061 Absolute Maximum Ratings¹

Parameter	Symbol	Minimum	Maximum	Units
Reverse voltage	V _R		Minimum reverse breakdown voltage	V
Forward current	I _F		50	mA
Power dissipation	P _D		75	mW
Storage temperature	T _{STG}	-65	+200	°C
Operating temperature	T _A	-65	+150	°C
Electrostatic discharge:	ESD			
Charged Device Model (CDM), Class 4			1000	V
Human Body Model (HBM), Class 1A			250	V
Machine Model (MM), Class A			<30	V

¹ Exposure to maximum rating conditions for extended periods may reduce device reliability. There is no damage to device with only one parameter set at the limit and all other parameters set at or below their nominal value. Exceeding any of the limits listed here may result in permanent damage to the device.

ESD HANDLING: *Although this device is designed to be as robust as possible, electrostatic discharge (ESD) can damage this device. This device must be protected at all times from ESD when handling or transporting. Static charges may easily produce potentials of several kilovolts on the human body or equipment, which can discharge without detection. Industry-standard ESD handling precautions should be used at all times.*

Table 2. SMSA7630-061 Electrical Specifications¹

(T_A = +25 °C, Unless Otherwise Noted)

Parameter	Symbol	Test Condition	Min	Typ	Max	Units
Breakdown voltage	V _B	I _R = 100 μA	1			V
Total capacitance	C _T	V _R = 0.15 V, f = 1 MHz		0.2		pF
Video resistance	R _V			5000		Ω
Series inductance	L _S			0.2		nH
Forward voltage	V _F	I _F = 0.1 mA I _F = 1 mA	60 135	180	120 240	mV mV

¹ Performance is guaranteed only under the conditions listed in this table.

Table 3. SPICE Model Parameters

Parameter	Units	SMSA7630-061
I _s	A	5E-06
R _s	Ω	20
N	-	1.05
T _T	sec	1E-11
C _{JO}	pF	0.14
M	-	0.4
E _G	eV	0.69
X _{TI}	-	2
F _c	-	0.5
B _v	V	2
I _{lev}	A	1E-04
V _J	V	0.34

Typical Performance Characteristics @ 25 °C

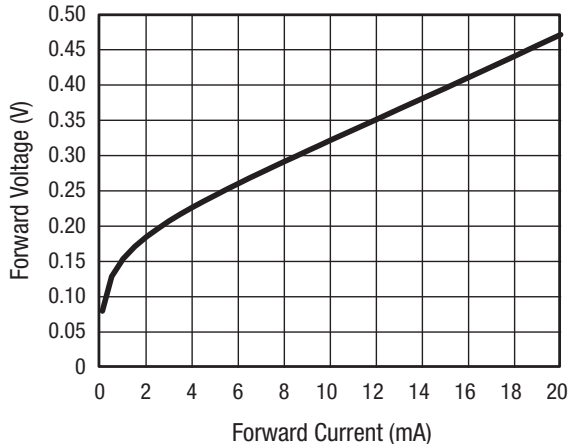

Figure 6. Forward Voltage vs Forward Current

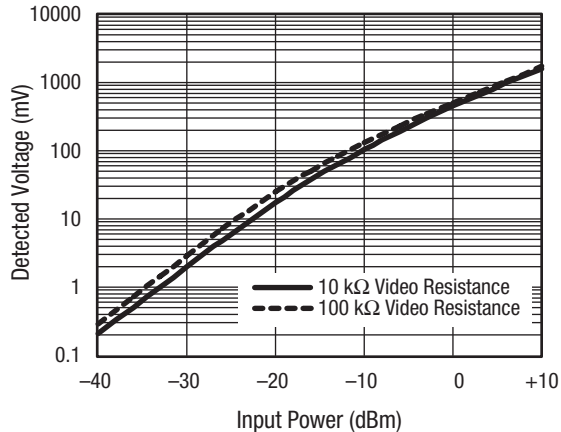

Figure 7. Detector Voltage vs Input Power

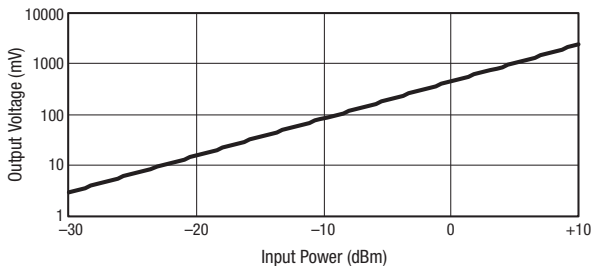

Figure 8. Output Voltage vs Input Power

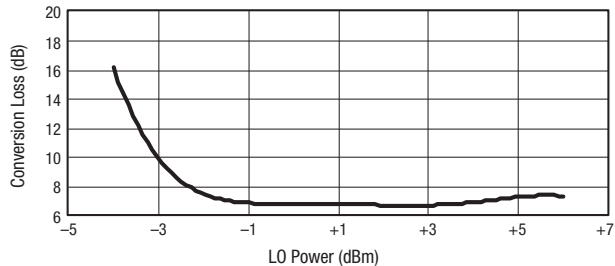

Figure 9. Conversion Loss vs LO Power

Package Dimensions

The PCB layout footprint for the SMSA7630-061 is provided in Figure 10. Package dimensions are shown in Figure 11, and tape and reel dimensions are provided in Figure 12.

Package and Handling Information

Instructions on the shipping container label regarding exposure to moisture after the container seal is broken must be followed. Otherwise, problems related to moisture absorption may occur when the part is subjected to high temperature during solder assembly.

The SMSA7630-061 is rated to Moisture Sensitivity Level 1 (MSL1) at 260 °C. It can be used for lead or lead-free soldering. For additional information, refer to the Skyworks Application Note, *Solder Reflow Information*, document number 200164.

Care must be taken when attaching this product, whether it is done manually or in a production solder reflow environment. Production quantities of this product are shipped in a standard tape and reel format.

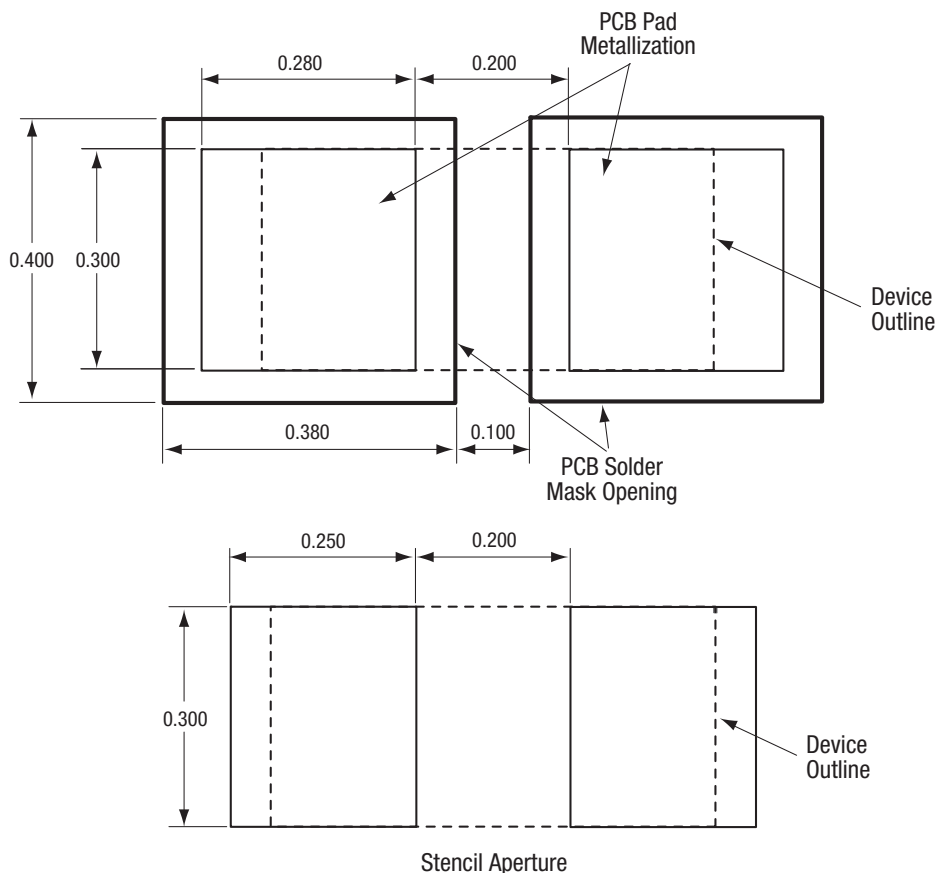

All measurements are in millimeters

S2030

Figure 10. SMSA7630-061 PCB Layout Footprint

DATA SHEET • SMSA7630-061: SURFACE-MOUNT, 0201 ZERO BIAS SILICON SCHOTTKY DETECTOR DIODE

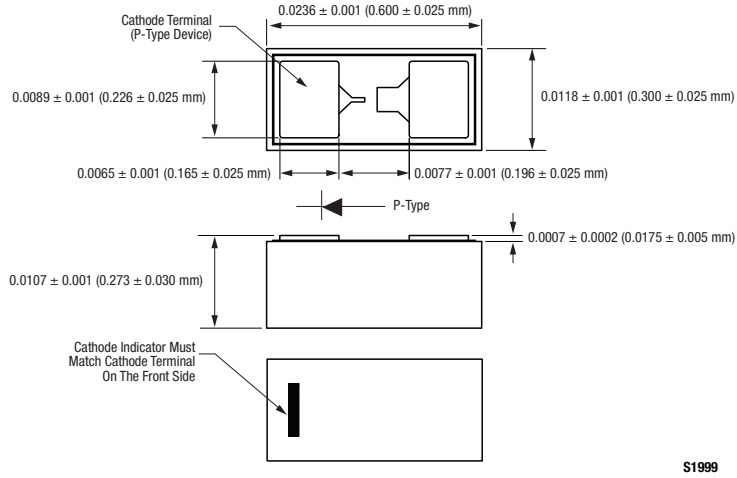
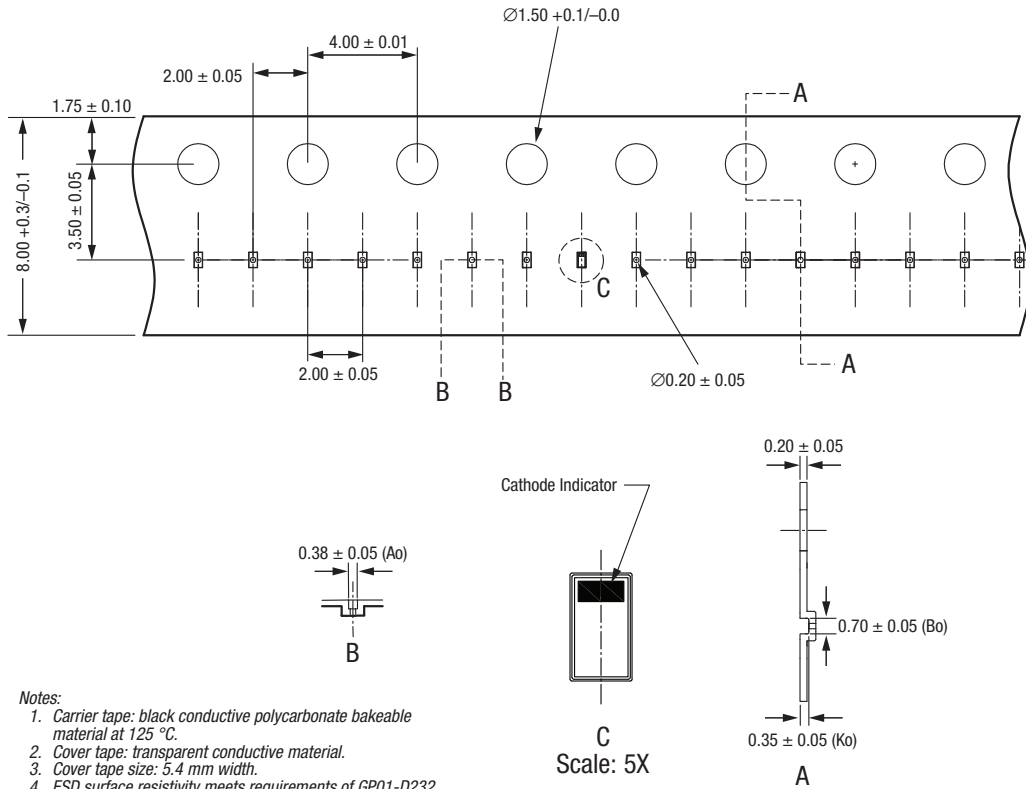

Figure 11. SMSA7630-061 Package Dimension Drawing



Notes:

1. Carrier tape: black conductive polycarbonate bakeable material at 125 °C.
2. Cover tape: transparent conductive material.
3. Cover tape size: 5.4 mm width.
4. ESD surface resistivity meets requirements of GP01-D232.
5. All measurements are in millimeters.

Figure 12. SMSA7630-061 Tape and Reel Dimensions

Copyright © 2014-2015, 2018-2019 Skyworks Solutions, Inc. All Rights Reserved.

Information in this document is provided in connection with Skyworks Solutions, Inc. ("Skyworks") products or services. These materials, including the information contained herein, are provided by Skyworks as a service to its customers and may be used for informational purposes only by the customer. Skyworks assumes no responsibility for errors or omissions in these materials or the information contained herein. Skyworks may change its documentation, products, services, specifications or product descriptions at any time, without notice. Skyworks makes no commitment to update the materials or information and shall have no responsibility whatsoever for conflicts, incompatibilities, or other difficulties arising from any future changes.

No license, whether express, implied, by estoppel or otherwise, is granted to any intellectual property rights by this document. Skyworks assumes no liability for any materials, products or information provided hereunder, including the sale, distribution, reproduction or use of Skyworks products, information or materials, except as may be provided in Skyworks Terms and Conditions of Sale.

THE MATERIALS, PRODUCTS AND INFORMATION ARE PROVIDED "AS IS" WITHOUT WARRANTY OF ANY KIND, WHETHER EXPRESS, IMPLIED, STATUTORY, OR OTHERWISE, INCLUDING FITNESS FOR A PARTICULAR PURPOSE OR USE, MERCHANTABILITY, PERFORMANCE, QUALITY OR NON-INFRINGEMENT OF ANY INTELLECTUAL PROPERTY RIGHT; ALL SUCH WARRANTIES ARE HEREBY EXPRESSLY DISCLAIMED. SKYWORKS DOES NOT WARRANT THE ACCURACY OR COMPLETENESS OF THE INFORMATION, TEXT, GRAPHICS OR OTHER ITEMS CONTAINED WITHIN THESE MATERIALS. SKYWORKS SHALL NOT BE LIABLE FOR ANY DAMAGES, INCLUDING BUT NOT LIMITED TO ANY SPECIAL, INDIRECT, INCIDENTAL, STATUTORY, OR CONSEQUENTIAL DAMAGES, INCLUDING WITHOUT LIMITATION, LOST REVENUES OR LOST PROFITS THAT MAY RESULT FROM THE USE OF THE MATERIALS OR INFORMATION, WHETHER OR NOT THE RECIPIENT OF MATERIALS HAS BEEN ADVISED OF THE POSSIBILITY OF SUCH DAMAGE.

Skyworks products are not intended for use in medical, lifesaving or life-sustaining applications, or other equipment in which the failure of the Skyworks products could lead to personal injury, death, physical or environmental damage. Skyworks customers using or selling Skyworks products for use in such applications do so at their own risk and agree to fully indemnify Skyworks for any damages resulting from such improper use or sale.

Customers are responsible for their products and applications using Skyworks products, which may deviate from published specifications as a result of design defects, errors, or operation of products outside of published parameters or design specifications. Customers should include design and operating safeguards to minimize these and other risks. Skyworks assumes no liability for applications assistance, customer product design, or damage to any equipment resulting from the use of Skyworks products outside of stated published specifications or parameters.

Skyworks and the Skyworks symbol are trademarks or registered trademarks of Skyworks Solutions, Inc. or its subsidiaries in the United States and other countries. Third-party brands and names are for identification purposes only, and are the property of their respective owners. Additional information, including relevant terms and conditions, posted at www.skyworksinc.com, are incorporated by reference.

Looking for pricing, stock, or lifecycle information?

Click below to explore more details on WIN SOURCE:

- ⊖ [View SMSA7630-061 on WIN SOURCE](#)
- ⊖ [Skyworks Solutions Inc. Information](#)

Optimize Your Supply Chain with WIN SOURCE Solutions

- ✓ Global Sourcing Solution
- ✓ Obsolete Management
- ✓ Cost Control Management
- ✓ Shortage Management
- ✓ Alternative Solution
- ✓ Excess Inventory Management