



**THE DATASHEET OF  
SMAJ4753AE3/TR13**





8700 E. Thomas Road  
 Scottsdale, AZ 85252  
 Phone: (480) 941-6300  
 Fax: (480) 947-1503

**SMAJ4728A  
 THRU  
 SMAJ4764A**

**SILICON  
 2 WATT  
 ZENER DIODES**

**Features**

- For surface mount applications (flat handling surface for accurate placement)
- 3.3 thru 100 Volt Voltage Range
- High Surge Current Rating
- Higher Voltages Available
- Electrically Equivalent to JEDEC Registered 1N4728A thru 1N4764A
- Available on Tape and Reel.

**Mechanical Data**

- Package similar to JEDEC DO-214AC (see dimension 'A' note)
- Terminals solderable per MIL-STD-750, Method 2026
- Polarity is indicated by cathode band.
- Maximum temperature for soldering: 260°C for 10 seconds.
- For surface mount applications with flame retardent epoxy meeting UL94V-0

**Maximum Ratings @ 25°C Unless Otherwise Specified**

Maximum Forward Voltage	$V_F$	1.2V	(Note: 1)
Peak Surge Current	$I_s$	See Table 1	
Steady State Power Dissipation	$P_{(AV)}$	2.0W	(Note: 2,3)
Operating And Storage Temperatures	$T_J, T_{STG}$	-55°C to +150°C	
Thermal Resistance	$R_{\theta JL}$	25°C/W	

**NOTES:**

1. Forward Current @ 200mA.
2. Mounted on 4.0mm<sup>2</sup> copper pads to each terminal.
3. Lead temperature at 100°C or less. Derate linearly above 100°C to zero power at 150°C.

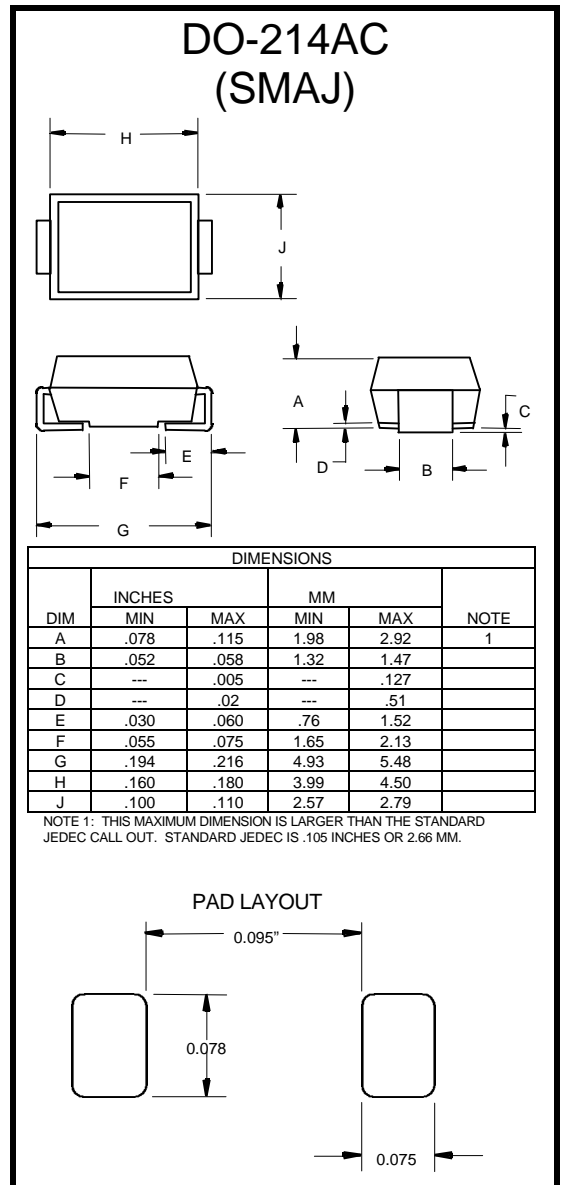

## SMAJ4728A thru SMAJ4764A

### Electrical Characteristics @ 25°C Unless Otherwise Specified

PART NUMBER	ZENER VOLTAGE (V <sub>Z</sub> ) (NOTE 4)	TEST CURRENT (I <sub>ZT</sub> )	MAXIMUM DYNAMIC IMPEDANCE (Z <sub>ZT</sub> @ I <sub>ZT</sub> ) (NOTE 2)	MAXIMUM REVERSE CURRENT (I <sub>R</sub> @ V <sub>R</sub> )	TEST VOLTAGE (V <sub>R</sub> )	MAXIMUM REGULATOR CURRENT (I <sub>ZM</sub> ) T <sub>L</sub> = 100 °C	MAXIMUM KNEE IMPEDANCE (Z <sub>ZK</sub> @ I <sub>ZK</sub> ) (NOTE 2)	TEST CURRENT (I <sub>ZK</sub> )	MAXIMUM (SURGE) CURRENT (I <sub>S</sub> ) (NOTE 3)
	VOLTS	mA	OHMS	µA	VOLTS	MA	OHMS	mA	mA
SMAJ4728A	3.3	76	10	100	1	552	400	1.0	1380
SMAJ4729A	3.6	69	10	100	1	504	400	1.0	1260
SMAJ4730A	3.9	64	9	50	1	468	400	1.0	1190
SMAJ4731A	4.3	58	9	10	1	434	400	1.0	1070
SMAJ4732A	4.7	53	8	10	1	386	500	1.0	970
SMAJ4733A	5.1	49	7	10	1	356	550	1.0	890
SMAJ4734A	5.6	45	5	10	2	324	600	1.0	810
SMAJ4735A	6.2	41	2	10	3	292	700	1.0	730
SMAJ4736A	6.8	37	3.5	10	4	266	700	1.0	660
SMAJ4737A	7.5	34	4.0	10	5	242	700	0.5	605
SMAJ4738A	8.2	31	4.5	10	6	220	700	0.5	550
SMAJ4739A	9.1	28	5.0	10	7	200	700	0.5	500
SMAJ4740A	10	25	7	10	7.6	182	700	0.25	454
SMAJ4741A	11	23	8	5	8.4	166	700	0.25	414
SMAJ4742A	12	21	9	5	9.1	152	700	0.25	380
SMAJ4743A	13	19	10	5	9.9	138	700	0.25	344
SMAJ4744A	15	17	14	5	11.4	132	700	0.25	304
SMAJ4745A	16	15.5	16	5	12.2	114	700	0.25	285
SMAJ4746A	18	14	20	5	13.7	100	750	0.25	250
SMAJ4747A	20	12.5	22	5	15.2	90	750	0.25	225
SMAJ4748A	22	11.5	23	5	16.7	82	720	0.25	205
SMAJ4749A	24	10.5	25	5	18.2	76	750	0.25	190
SMAJ4750A	27	9.5	35	5	20.6	68	750	0.25	170
SMAJ4751A	30	8.5	40	5	22.8	60	1000	0.25	150
SMAJ4752A	33	7.5	45	5	25.1	54	1000	0.25	135
SMAJ4753A	36	7.0	50	5	27.4	50	1000	0.25	125
SMAJ4754A	39	6.5	60	5	29.7	46	1000	0.25	115
SMAJ4755A	43	6.0	70	5	32.7	44	1500	0.25	110
SMAJ4756A	47	5.5	80	5	35.8	38	1500	0.25	95
SMAJ4757A	51	5.0	95	5	38.8	36	1500	0.25	90
SMAJ4758A	56	4.5	110	5	42.6	32	2000	0.25	80
SMAJ4759A	62	4.0	125	5	47.1	28	2000	0.25	70
SMAJ4760A	68	3.7	150	5	51.7	26	2000	0.25	65
SMAJ4761A	75	3.3	175	5	56.0	24	2000	0.25	60
SMAJ4762A	82	3.0	200	5	62.2	22	3000	0.25	55
SMAJ4763A	91	2.8	250	5	69.2	20	3000	0.25	50
SMAJ4764A	100	2.5	350	5	76.0	18	3000	0.25	45

- NOTE:**
- The type numbers shown have a 5% tolerance on nominal zener voltage. No suffix signifies a 10% tolerance, C signifies 2%, and D signifies 1% tolerance.
  - The Zener impedance is derived from the 60 Hz ac voltage, which results when an ac current having an rms value equal to 10% of the dc Zener current (I<sub>ZT</sub> or I<sub>ZK</sub>) is superimposed on I<sub>ZT</sub>. Zener impedance is measured at two points to insure a sharp knee on the breakdown curve and eliminate unstable units.
  - The reverse surge current is measured at 25 °C ambient using a square wave or equivalent sine wave pulse 1/120 second duration superimposed on I<sub>ZT</sub>.
  - Voltage at thermal equilibrium or 90 seconds after application of dc current.

## Looking for pricing, stock, or lifecycle information?

Click below to explore more details on WIN SOURCE:

⊖ [View SMAJ4753AE3/TR13 on WIN SOURCE](#)

⊖ [Microchip Technology](#) Information

## Optimize Your Supply Chain with WIN SOURCE Solutions

- ✓ Global Sourcing Solution
- ✓ Obsolete Management
- ✓ Cost Control Management
- ✓ Shortage Management
- ✓ Alternative Solution
- ✓ Excess Inventory Management