

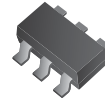

**THE DATASHEET OF
CSRS065V0P**



CSRS065V0P (RoHS Device)



Features

- ESD Protect for 4 high-speed I/O channels.
- IEC61000-4-2 (ESD) \pm 14kV(Contact), \pm 18kV(Air).
- IEC61000-4-4 (FET)20A for I/O,80A for Power.
- Working voltage: 5V
- Low capacitance:1.3pF(Typ.).
- High component density.

Mechanical data

- Case: SOT-23-6 standard package, molded plastic.
- Terminals: Solder plated, solderable per MIL-STD-750,method 2026.
- Mounting position: Any
- Weight: 0.015 gram (approx.).

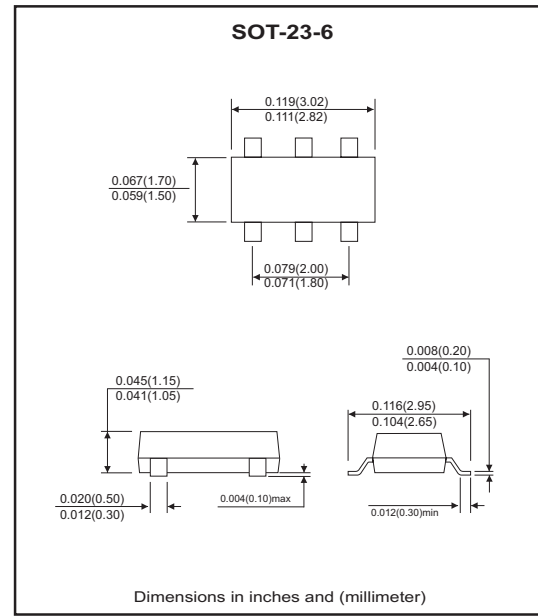

Circuit Diagram

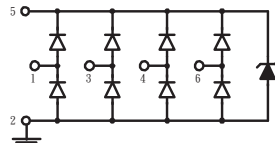

Pin Configuration

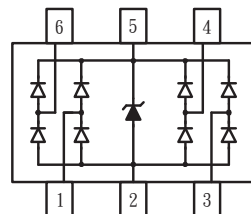

Maximum Rating (at TA=25°C unless otherwise noted)

Parameter	Symbol	Value	Unit
Peak pulse current (tp = 8/20 us)	I _{PP}	6.5	A
Operating supply voltage	V _{DC}	6	V
ESD per IEC 61000-4-2(Air)	ESD	18	kV
ESD per IEC 61000-4-2(Contact)		14	
ESD per IEC 61000-4-2(Air)(VDD-GND)	ESD _{VDD}	30	kV
ESD per IEC 61000-4-2(Contact)(VDD-GND)			
Lead soldering temperature	T _{SOL}	260 (10 sec)	°C
Operating temperature	T _j	-55 to +85	°C
Storage temperature	T _{STG}	-55 to +125	°C
DC voltage at any I/O pin	V _{IO}	(GND -0.5) to (VDD +0.5)	V

Low Capacitance ESD Protection Array



SMD Diodes Specialist

Electrical Characteristics (at TA=25°C unless otherwise noted)

Parameter	Conditions	Symbol	Min	Typ	Max	Unit
Reverse stand-Off voltage	Pin 5 to Pin 2	V_{RWM}			5	V
Reverse leakage current	$V_{RWM} = 5\text{ V}$, Pin 5 to Pin 2	I_R			5	uA
	$V_{PIN\ 5} = 5\text{ V}$, $V_{PIN\ 2} = 0\text{ V}$, $V_{IO} = 0\sim 5\text{ V}$				1	
Diode breakdown voltage	$I_R = 1\text{ mA}$, Pin 5 to Pin 2	V_{BD}	6		9	V
Forward voltage	$I_F = 15\text{ mA}$, Pin 2 to Pin 5	V_F		0.8	1	V
Clamping voltage	$I_{PP} = 5\text{ A}$, $t_p=8/20\mu\text{s}$, Any Channel Pin to Ground	V_C		8.1	9	V
	IEC 61000-4-2 +6kV, Contact mode Any Channel Pin to Ground			12.5		
	IEC 61000-4-2 +6kV, Contact mode VDD Pin to Ground			9		
Junction capacitance	$V_{pin5} = 5\text{ V}$, $V_{pin2} = 0\text{ V}$, $V_{IO} = 2.5\text{ V}$, $f = 1\text{ MHz}$, Any Channel Pin to Ground	C_j		1.3	1.6	pF
	$V_{pin5} = 5\text{ V}$, $V_{pin2} = 0\text{ V}$, $V_{IO} = 2.5\text{ V}$, $f = 1\text{ MHz}$, Between Channel Pins			0.12	0.14	
	$V_{pin5} = 5\text{ V}$, $V_{pin2} = 0\text{ V}$, $V_{IN} = 2.5\text{ V}$, $f = 1\text{ MHz}$, Channel_x pin to ground - channel_y pin to ground			0.05	0.07	

RATING AND CHARACTERISTIC CURVES (CSRS065V0P)

Fig. 1 - Power derating curve

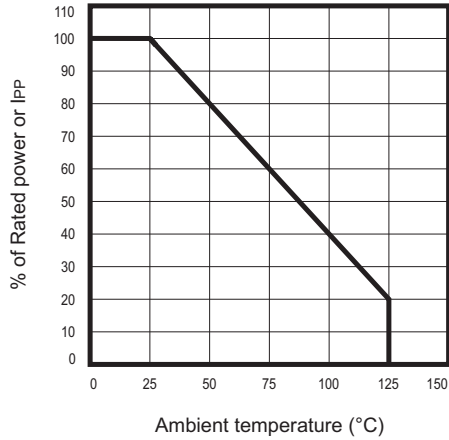

Fig. 2 - Clamping voltage vs. Peak pulse current

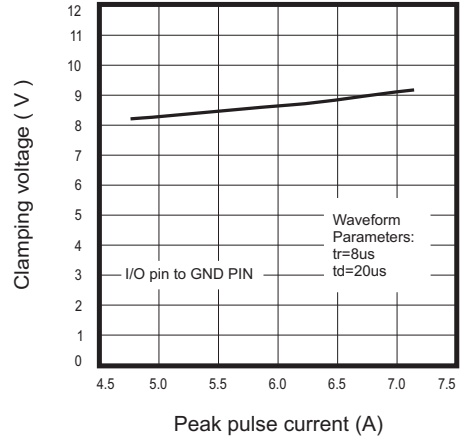

Fig.3 - Forward voltage v.s. forward current

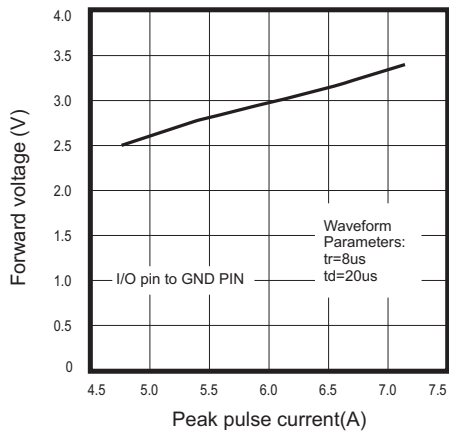

Fig.4 - Typical variation of C_{IN} v.s. V_{IN}

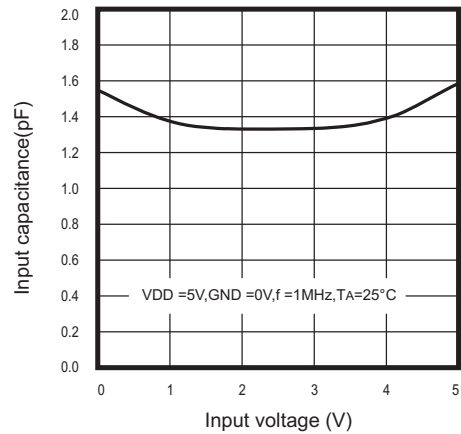

Fig. 5 - Typical variation of C_{IN} v.s. temperature

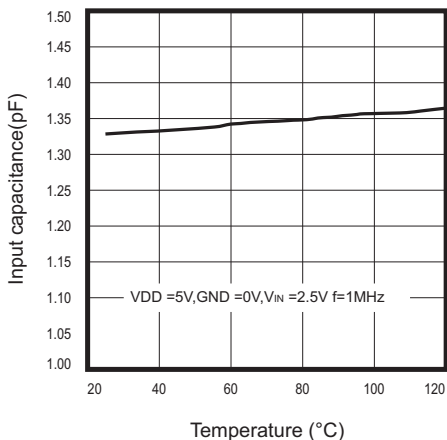

Fig. 6 - Transmission line pulsing (TLP) measurement

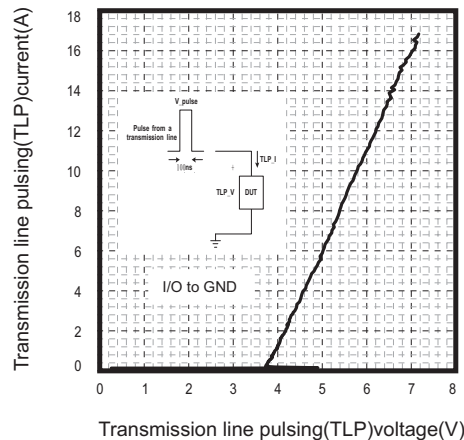
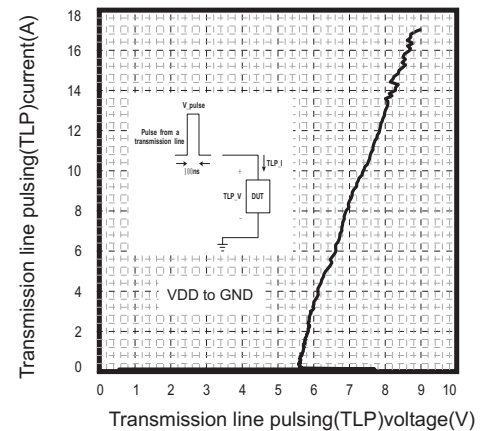
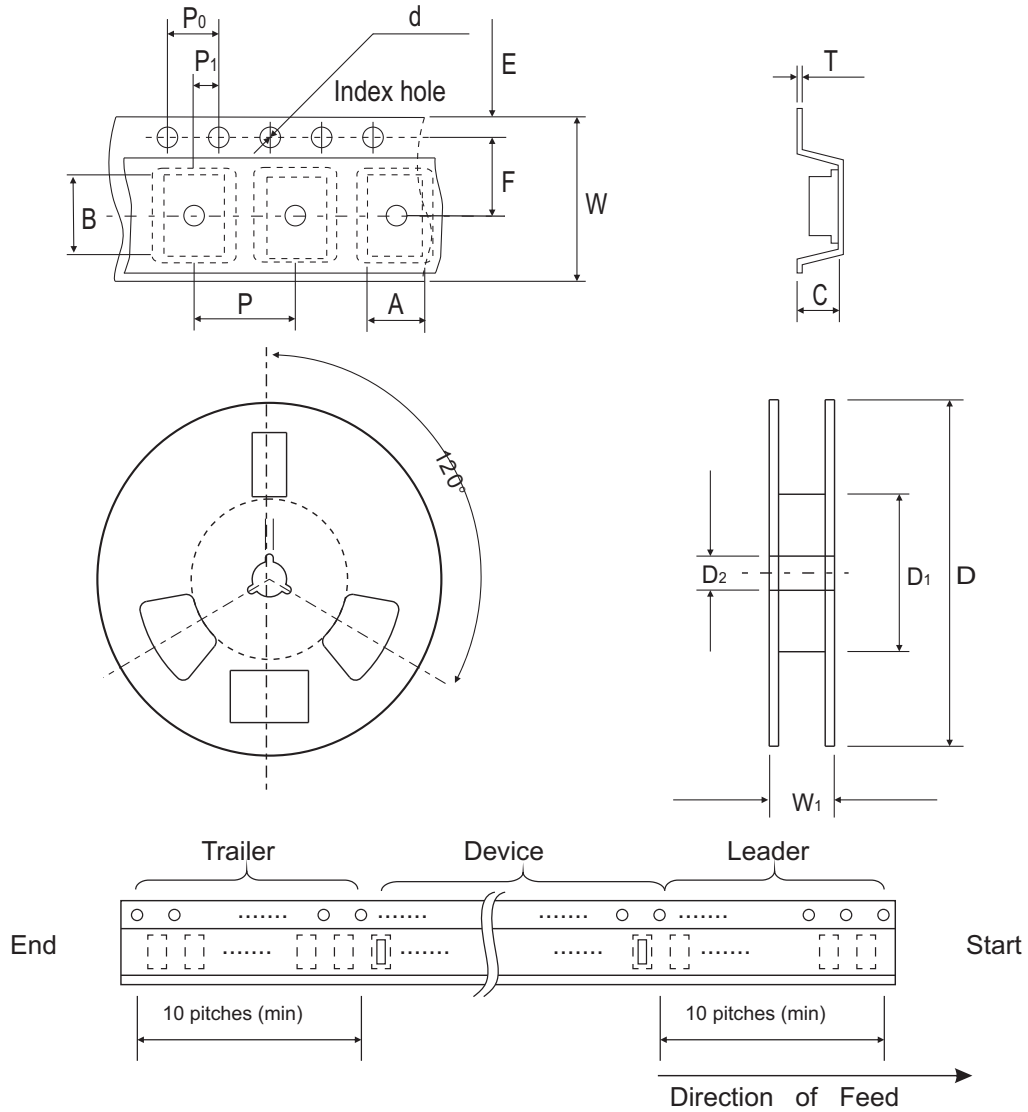

Fig.7 -Transmission line pulsing (TLP) measurement



Reel Taping Specification



SOT-23-6	SYMBOL	A	B	C	d	D	D ₁	D ₂
	(mm)	3.17 ± 0.10	3.23 ± 0.10	1.37 ± 0.10	1.55 ± 0.10	178 ± 1	50.0 MIN.	13.0 ± 0.20
	(inch)	0.124 ± 0.004	0.127 ± 0.004	0.054 ± 0.004	0.061 ± 0.004	7.008 ± 0.040	1.969 MIN.	0.512 ± 0.008

SOT-23-6	SYMBOL	E	F	P	P ₀	P ₁	W	W ₁
	(mm)	1.75 ± 0.10	3.50 ± 0.05	4.00 ± 0.10	4.00 ± 0.10	2.00 ± 0.05	8.00 ± 0.30	14.4 MAX.
	(inch)	0.069 ± 0.004	0.138 ± 0.002	0.157 ± 0.004	0.157 ± 0.004	0.079 ± 0.002	0.315 ± 0.012	0.567 MAX.

Marking Code

Part Number	Marking Code
CSRS065V0P	C05

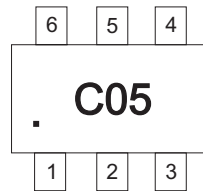

Suggested PAD Layout

SIZE	SOT-23-6	
	(mm)	(inch)
A	1.10	0.043
B	0.60	0.024
C	0.95	0.037
D	2.50	0.098
E	3.60	0.142

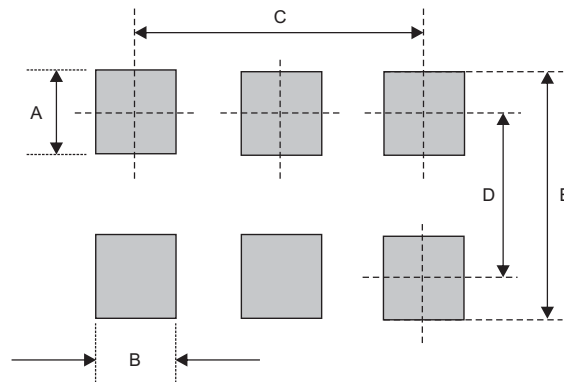



Standard Package

Case Type	Qty per Reel	Reel Size
	(Pcs)	(inch)
SOT-23-6	3000	7

Looking for pricing, stock, or lifecycle information?

Click below to explore more details on WIN SOURCE:

-  [View CSRS065V0P on WIN SOURCE](#)
-  [Comchip Technology Information](#)

Optimize Your Supply Chain with WIN SOURCE Solutions

-  Global Sourcing Solution
-  Obsolete Management
-  Cost Control Management
-  Shortage Management
-  Alternative Solution
-  Excess Inventory Management