



**THE DATASHEET OF
STGIPL35K120L1**





STGIPL35K120L1

SLLIMM™ (small low-loss intelligent molded module) IPM, single phase - 35 A, 1200 V short-circuit rugged IGBT

Datasheet – preliminary data

Features

- IPM 35 A, 1200 V single phase IGBT including control ICs for gate driving and free-wheeling diodes
- Short-circuit rugged IGBTs
- $V_{CE(sat)}$ negative temperature coefficient
- Active Miller clamp feature
- Undervoltage lockout
- Desaturation detection
- Fault status output
- Input compatible with pulse transformer or optocoupler
- DBC substrate leading to low thermal resistance
- Isolation rating of 2500 V_{rms}/min
- 4.7 kΩ NTC for temperature control

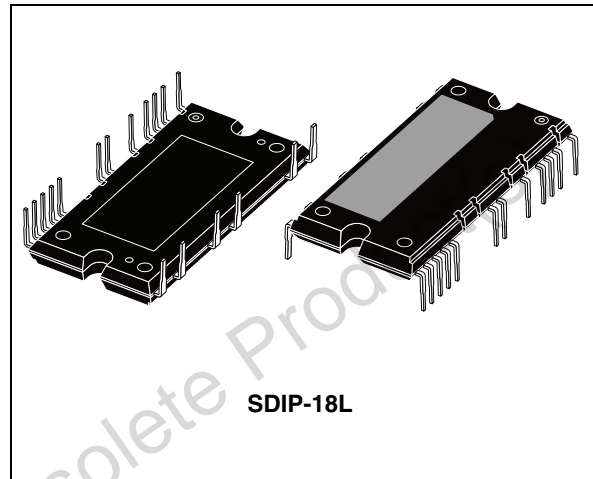

Applications

- Power inverters

Description

This intelligent power module provides a compact, high performance AC motor drive for a simple and rugged design. It targets power inverters for air conditioners. It combines ST proprietary control ICs with the most advanced short-circuit rugged IGBT system technology. SLLIMM™ is a trademark of STMicroelectronics.

Table 1. Device summary

Order code	Marking	Package	Packaging
STGIPL35K120L1	GIPL35K120L1	SDIP-18L	Tube

Contents

1	Internal block diagram and pin configuration	3
2	Electrical ratings	5
2.1	Absolute maximum ratings	5
2.2	Thermal data	6
3	Electrical characteristics	7
3.1	Control part	9
3.1.1	NTC thermistor	10
3.2	Recommendations	11
4	Functional description	12
4.1	Input	12
4.2	Voltage reference	12
4.3	Desaturation protection	12
4.4	Active Miller clamp	13
4.5	Fault status output	13
4.6	Undervoltage protection	13
5	Package mechanical data	14
6	Revision history	18

1 Internal block diagram and pin configuration

Figure 1. Internal block diagram

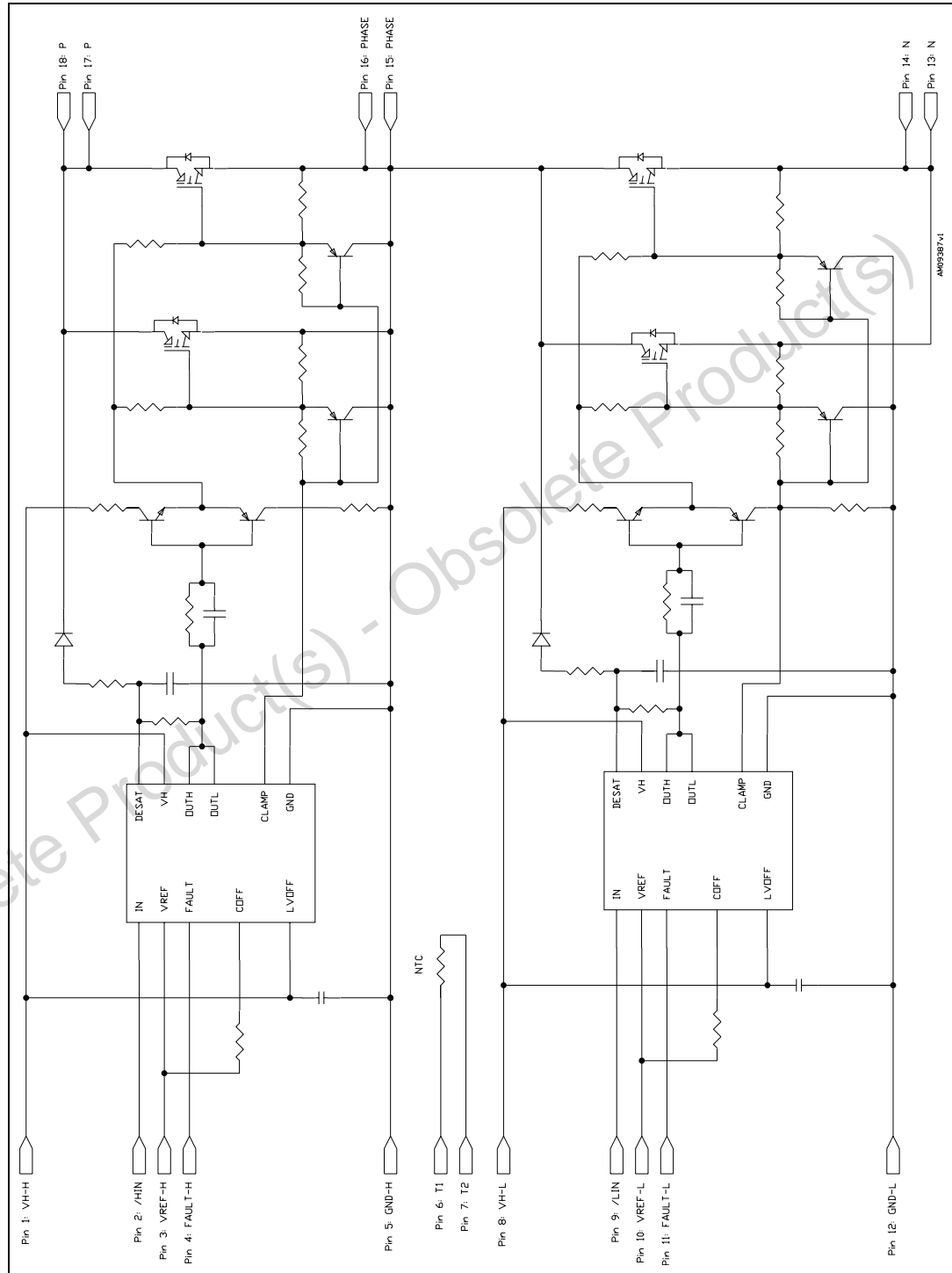
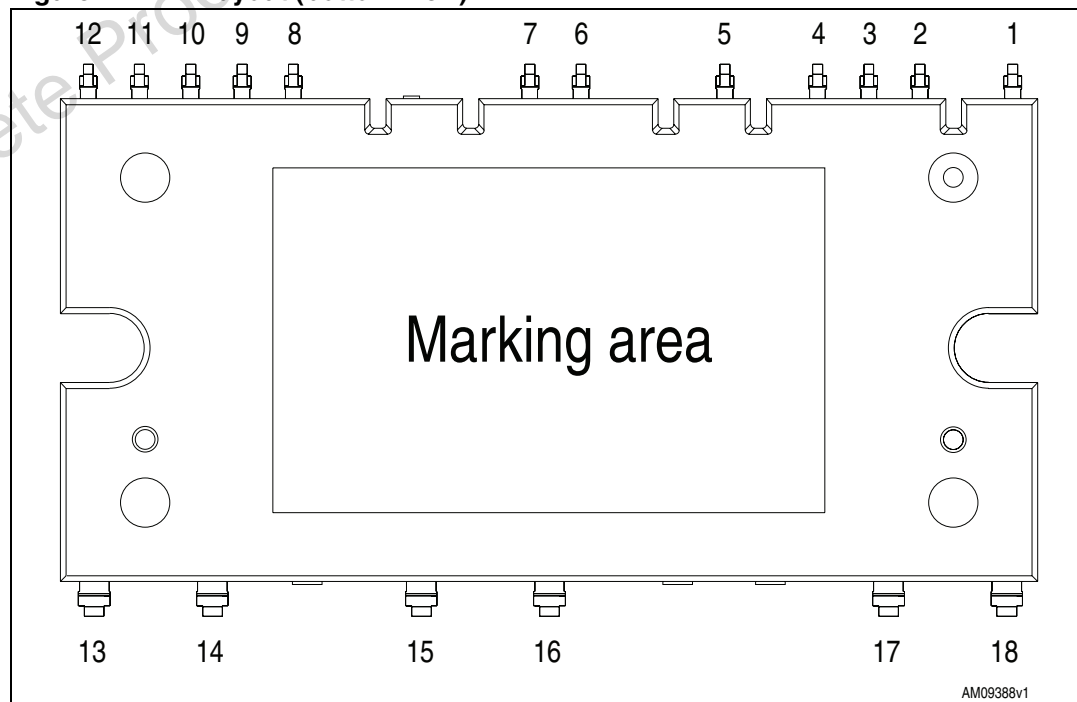

Table 2. Pin description

Pin	Symbol	Description
1	VH-H	High side gate driver power supply
2	$\overline{\text{HIN}}$	High side logic input (active low)
3	VREF-H	High side gate driver +5 V reference voltage
4	FAULT-H	High side gate driver fault output status
5	GND-H	High side gate driver ground
6	T1	NTC thermistor terminal 1
7	T2	NTC thermistor terminal 2
8	VH-L	Low side gate driver power supply
9	$\overline{\text{LIN}}$	Low side logic input (active low)
10	VREF-L	Low side gate driver +5 V reference voltage
11	FAULT-L	Low side gate driver fault output status
12	GND-L	Low side gate driver ground
13	N	Negative DC input
14	N	Negative DC input
15	PHASE	Phase output
16	PHASE	Phase output
17	P	Positive DC input
18	P	Positive DC input

Figure 2. Pin layout (bottom view)

2 Electrical ratings

2.1 Absolute maximum ratings

Table 3. Inverter part

Symbol	Parameter	Value	Unit
V_{CE}	Each IGBT collector emitter voltage	1200	V
$\pm I_C^{(1)}$	Each IGBT continuous collector current at $T_C = 25^\circ\text{C}$	35	A
$\pm I_{CP}^{(2)}$	Each IGBT pulsed collector current	70	A
P_{TOT}	Each IGBT total dissipation at $T_C = 25^\circ\text{C}$	100	W
t_{scw}	Short circuit withstand time, $V_{CE} = 0.5 V_{(BR)CES}$ $T_J = 125^\circ\text{C}$, $V_{H-H} = 15\text{ V}$, $V_I = 1$ "logic state"	5	μs

1. Calculated according to the iterative formula:

$$I_C(T_C) = \frac{T_{j(\max)} - T_C}{R_{thj-c} \times V_{CE(\text{sat})(\max)}(T_{j(\max)}, I_C(T_C))}$$

2. Pulse width limited by max junction temperature

Table 4. Control part

Symbol	Parameter	Value	Unit
VH	Maximum VH-H, VH-L voltages vs. GND	28	V
V_{fault}	Voltage on FAULT pin	-0.3 to VH+0.3	V
V_{other}	Voltage on other pins (IN, VREF)	-0.3 to 7	V

Table 5. Total system

Symbol	Parameter	Value	Unit
V_{ISO}	Isolation withstand voltage applied between each pin and heatsink plate (AC voltage, $t = 60$ sec.)	2500	V
$T_J^{(1)}$	Operating junction temperature for IGBT and diode	-40 to 150	$^\circ\text{C}$
T_C	Module case operation temperature	-40 to 125	$^\circ\text{C}$

1. The maximum junction temperature rating of the power chips integrated within the SDIP module is 150°C ($@T_C \leq 100^\circ\text{C}$). To ensure safe operation of the NDIP module, the average junction temperature should be limited to $T_{J(\text{avg})} \leq 125^\circ\text{C}$ ($@T_C \leq 100^\circ\text{C}$).

2.2 Thermal data

Table 6. Thermal data

Symbol	Parameter	Value	Unit
R_{thJC}	Thermal resistance junction-case single IGBT	0.9	°C/W
	Thermal resistance junction-case single diode	1.4	°C/W

Figure 3. Transient thermal impedance IGBT/diode - inverter

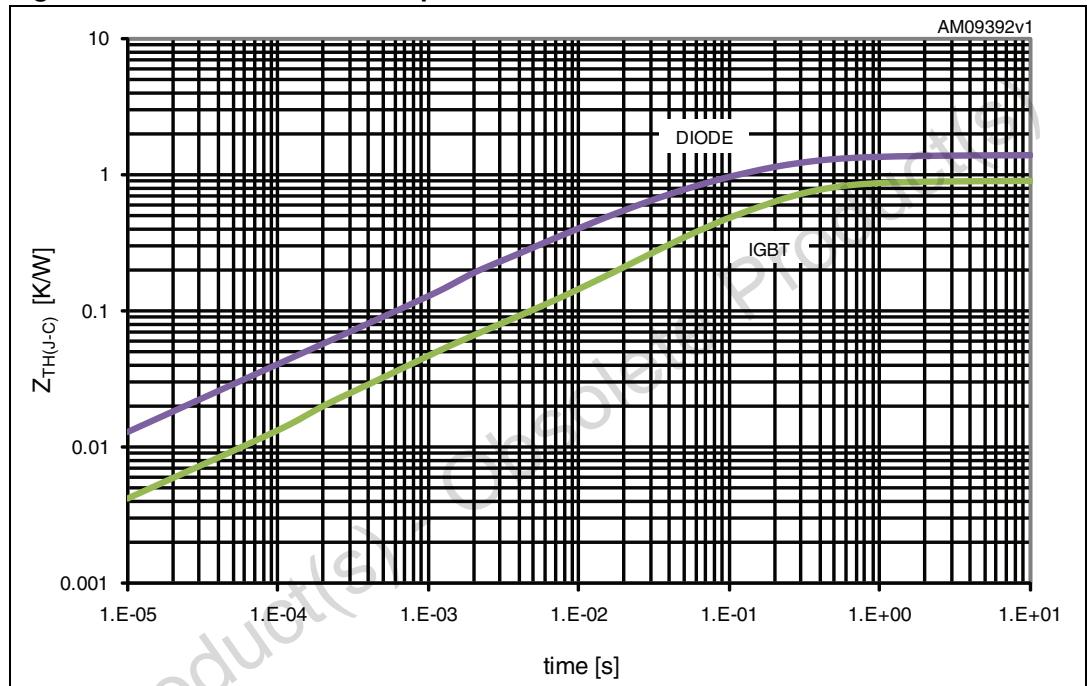

3 Electrical characteristics

$T_J = 25\text{ °C}$ unless otherwise specified.

Table 7. Inverter part

Symbol	Parameter	Test conditions	Value			Unit
			Min.	Typ.	Max.	
$V_{CE(sat)}$	Collector-emitter saturation voltage	V_{H-H} (V_{H-L}) = 15 V, $V_{IN}^{(1)} = 1$ "logic state", $I_C = 30$ A	-	2.8	3.6	V
		V_{H-H} (V_{H-L}) = 15 V, $V_{IN}^{(1)} = 1$ "logic state", $I_C = 30$ A, $T_J = 125\text{ °C}$	-	2.4		
I_{CES}	Collector-cut off current ($V_{IN}^{(1)} = 0$ "logic state")	$V_{CE} = 1200$ V, V_{H-H} (V_{H-L}) = 15 V	-		10	mA
V_F	Diode forward voltage	$V_{IN}^{(1)} = 0$ "logic state", $I_F = 30$ A	-		2.3	V
Switching on/off (inductive load) ⁽²⁾						
t_{on}	Turn-on time	$V_{DD} = 600$ V, V_{H-H} (V_{H-L}) = 15 V, $V_{IN} = 1$ "logic state" (see Table 9) $I_C = 30$ A (see Figure 4 and 5)	-	720	-	ns
$t_{c(on)}$	Crossover time (on)		-	300	-	
t_{off}	Turn-off time		-	880	-	
$t_{c(off)}$	Crossover time (off)		-	275	-	
t_{rr}	Reverse recovery time		-	520	-	
E_{on}	Turn-on switching losses		-	3.7	-	
E_{off}	Turn-off switching losses	-	1.9	-		
t_{on}	Turn-on time	$V_{DD} = 600$ V, V_{H-H} (V_{H-L}) = 15 V, $V_{IN} = 1$ "logic state" (see Table 9) $I_C = 30$ A, $T_J = 125\text{ °C}$ (see Figure 4 and 5)	-	820	-	ns
$t_{c(on)}$	Crossover time (on)		-	350	-	
t_{off}	Turn-off time		-	1400	-	
$t_{c(off)}$	Crossover time (off)		-	700	-	
t_{rr}	Reverse recovery time		-	620	-	
E_{on}	Turn-on switching losses		-	5.6	-	
E_{off}	Turn-off switching losses	-	5.8	-		

1. See [Table 9: Truth table](#).

2. t_{ON} and t_{OFF} include the propagation delay time of the internal drive. $t_{C(ON)}$ and $t_{C(OFF)}$ are the switching time of IGBT itself under the internally given gate driving condition. Parameter values take into account a 20 nH stray inductance.

Figure 4. Switching time test circuit

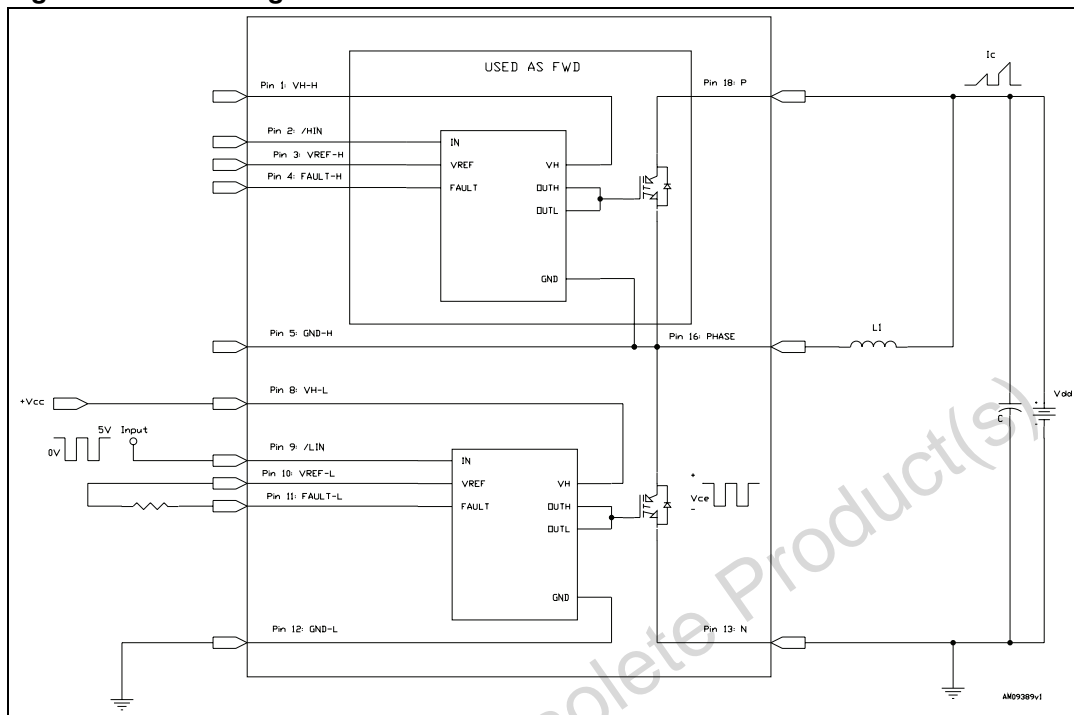
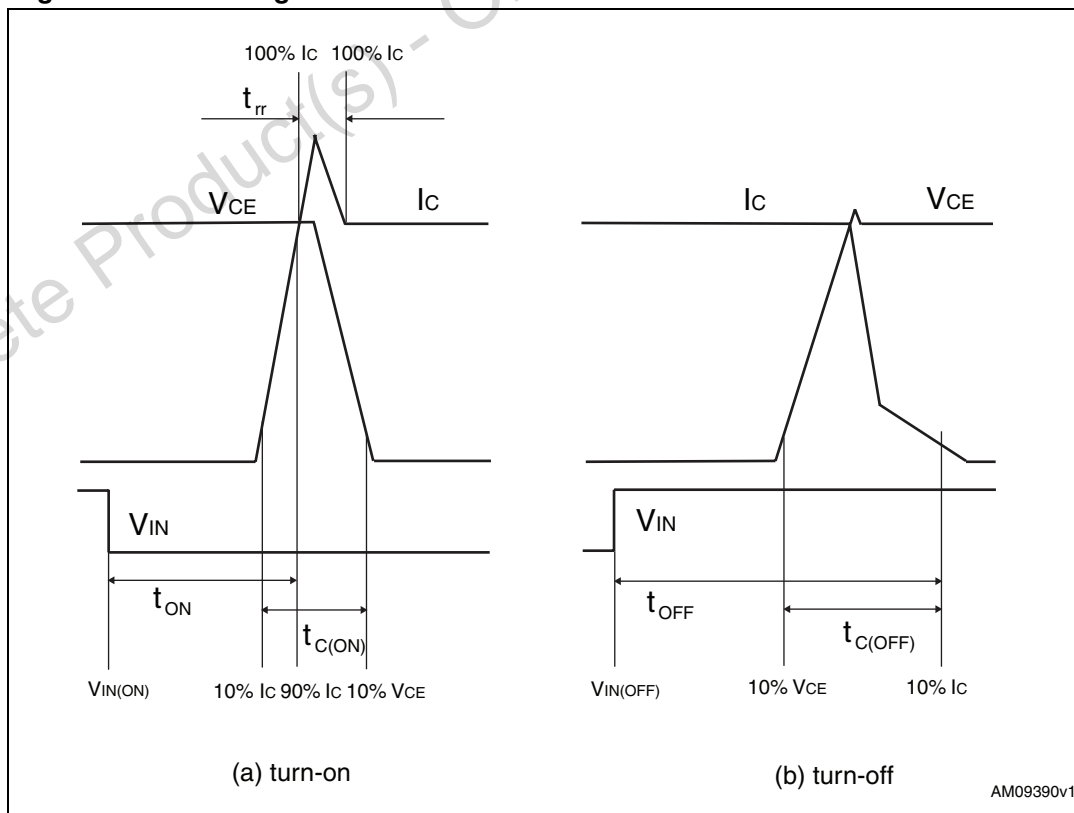

Figure 5. Switching time definition



3.1 Control part

$T_A = -20$ to 125 °C, $V_H = 16$ V (unless otherwise specified).

Table 8. Electrical characteristics

Symbol	Parameter	Test condition	Min	Typ	Max	Unit
Input						
V_{ton}	IN turn-on threshold voltage		0.8	1.0		V
V_{toff}	IN turn-off threshold voltage			4.0	4.2	V
t_{onmin}	Minimum pulse width		100	135	220	ns
I_{inp}	IN input current				1	μA
Voltage reference ⁽¹⁾						
V_{ref}	Voltage reference	$T_{min} < T < T_{max}$	4.77		5.22	V
I_{ref}	Maximum output current		10			mA
Fault output						
t_{fault}	Delay for fault detection				500	ns
V_{FL}	FAULT low voltage	$I_{FLsink} = 10$ mA			1	V
Under voltage lockout (UVLO)						
UVLOH	UVLO top threshold		10	11	12	V
UVLOL	UVLO bottom threshold		9	10	11	V
V_{hyst}	UVLO hysteresis	UVLOH-UVLOL	0.5	1		V
Supply current						
I_{in}	Quiescent current	Output = 0 V, no load			5	mA

1. Recommended capacitor range on VREF pin is 10 nF to 100 nF.

Table 9. Truth table

Condition	Logic input (V_I)		Output	
	LIN	HIN	Low side gate driver output	High side gate driver output
0 "logic state" half-bridge tri-state	H	H	L	L
1 "logic state" low side direct driving	L	H	H	L
1 "logic state" high side direct driving	H	L	L	H

Note: X: don't care

3.1.1 NTC thermistor

Table 10. NTC thermistor

Symbol	Parameter	Test conditions	Min.	Typ.	Max.	Unit.
R ₂₅	Resistance	T _C = 25°C		4.7		kΩ
R ₁₂₅	Resistance	T _C = 125°C		160		Ω
B	B-constant	T _C = 25°C		3950		K
T	Operating temperature		-40		150	°C

Equation 1: resistance variation vs. temperature

$$R(T) = R_{25} \cdot e^{B \left(\frac{1}{T} - \frac{1}{298} \right)}$$

Where T are temperatures in Kelvins

Figure 6. NTC resistance vs. temperature

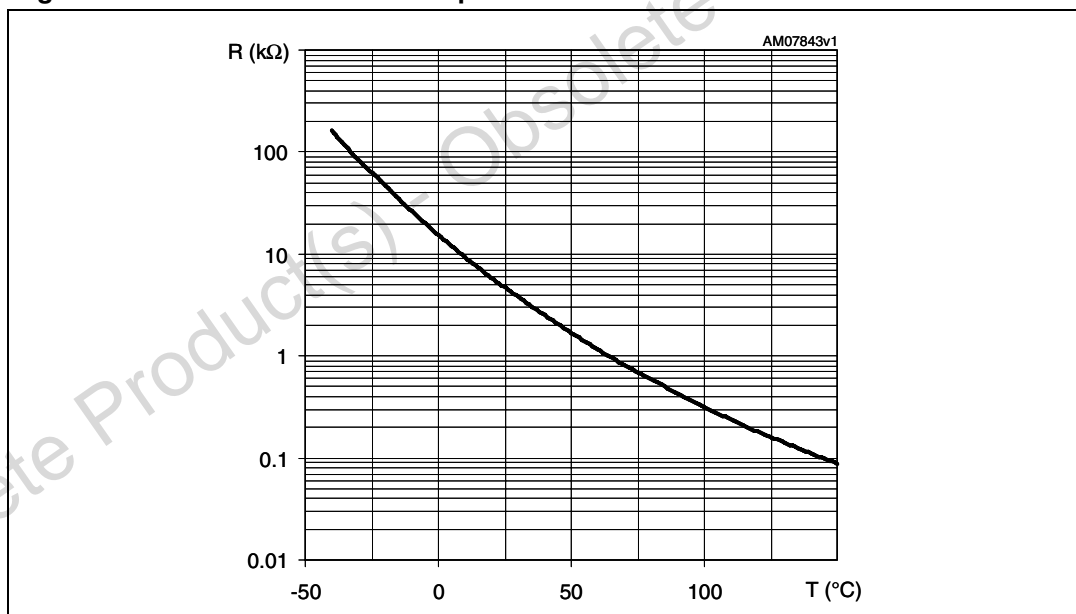

3.2 Recommendations

- As the IPM may be used in a very noisy environment, care should be taken to decouple the supplies. Small ceramic capacitors, connected inside the IPM as close as possible to the gate driver pins, are used to improve noise-withstand capability.
- The IPM is compatible with both pulse transformers or optocouplers. When using an optocoupler, the IN input must be limited to approximately 5 V. The pull-up resistor to V_H must be between 5 k Ω and 20 k Ω , depending on optocoupler characteristics. An optional filtering capacitor can be added in the event of a highly noisy environment, although the IPM already includes a filtering on input signals and rejects signals smaller than 100 ns (t_{ONMIN} specification).
- When using a pulse transformer, a 2.5 V reference point can be built from the 5 V V_{REF} pin with a resistor divider. The capacitor between the V_{REF} pin and the resistor divider middle point provides decoupling of the 2.5 V reference, and also ensures a high level on the IN input pin at power-up to start the IPM in OFF state. The waveform from the pulse transformer must comply with the t_{ONMIN} and V_{ION} / V_{IOFF} specifications. To turn ON the IPM outputs, the input signal must be lower than 0.8 V for at least 220 ns. Conversely, the input signal must be higher than 4.2 V for at least 200 ns to turn OFF the outputs. A pulse width of about 500 ns at these threshold levels is recommended. In all cases, the input signal at the IN pin must be between 0 and 5 V.
- To prevent the input signals oscillation, the wiring of each input should be as short as possible.
- Electrolytic bus capacitors should be mounted as close to the module bus terminals as possible. Additional high frequency ceramic capacitor mounted close to the module pins will further improve performance.
- When setting the maximum voltage to be applied between P-N, the internal stray inductance and the maximum di/dt should be considered. Due to both internal and layout stray inductances, the di/dt results in a voltage surges between the DC-link capacitor and the switches during commutations.
- FAULT pin is externally available to provide a feedback signal about IPM status. Please refer to undervoltage protection and desaturation fault timing diagrams for more information. Fault output signals the undervoltage state and is reset only when undervoltage state disappears. When a desaturation event occurs, the fault output is pulled down and IPM outputs are low (IGBT off) until the IN input signal is released (high level), then activated again (low level).

4 Functional description

4.1 Input

The input is compatible with optocouplers or pulse transformers. The input is triggered by the signal edge and allows the use of low-sized, low-cost pulse transformer. Input is active low (output is high when input is low) to ease the use of optocoupler. When driven by a pulse transformer, the input pulse (positive and negative) width must be larger than the minimum pulse width t_{onmin} .

4.2 Voltage reference

A voltage reference is used to create accurate timing for the two-level turn-off with external resistor and capacitor.

4.3 Desaturation protection

The desaturation function provides a protection against over-current events. Voltage across the IGBT is monitored, and the IGBT is turned off if the voltage threshold is reached. A blanking time is made of an internal current source and a capacitor.

During operation, the DESAT capacitor is discharged when IPM output is low (IGBT off). When the IGBT is turned on, the DESAT capacitor starts charging and desaturation protection is effective after the blanking time (fixed by design showing a typical value of 2 μ s).

When a desaturation event occurs, the fault output is pulled down and IPM outputs are low (IGBT off) until the IN input signal is released (high level), then activated again (low level).

Figure 7. Desaturation 1200 V

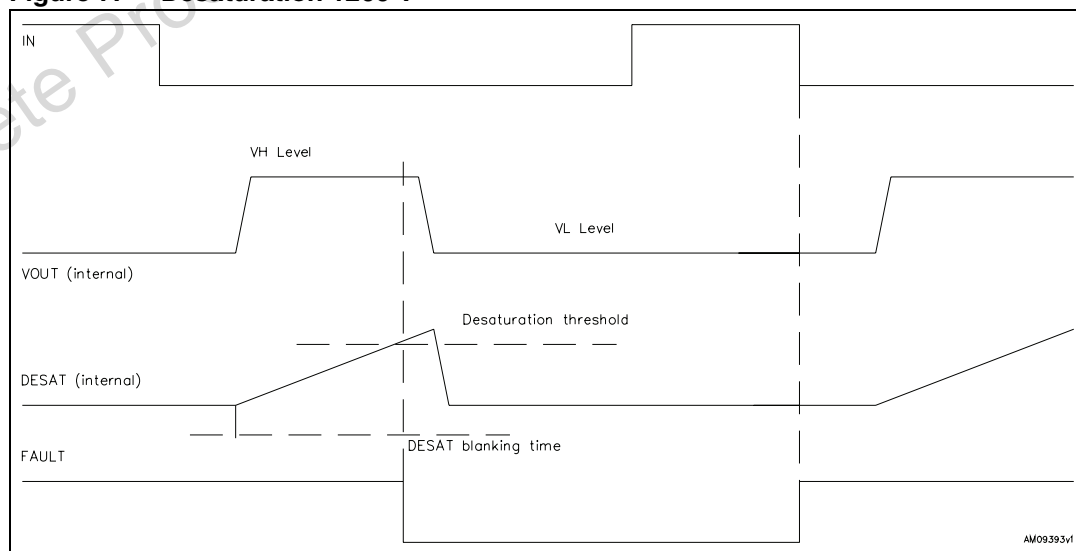

4.4 Active Miller clamp

A Miller clamp allows the control of the Miller current during a high dV/dt situation and can avoid the use of a negative supply voltage.

During turn-off, the gate voltage is monitored and the clamp output is activated when gate voltage goes below 2 V (relative to GND). The clamp is disabled when the IN input is triggered again.

4.5 Fault status output

Fault output is used to signal a fault event (desaturation, UVLO) to a controller. The fault pin is designed to drive an optocoupler.

4.6 Undervoltage protection

Undervoltage detection protects the application in the event of a low V_H supply voltage (during start-up or a fault situation). Fault output signals the undervoltage state and is reset only when undervoltage state disappears.

Figure 8. Undervoltage protection

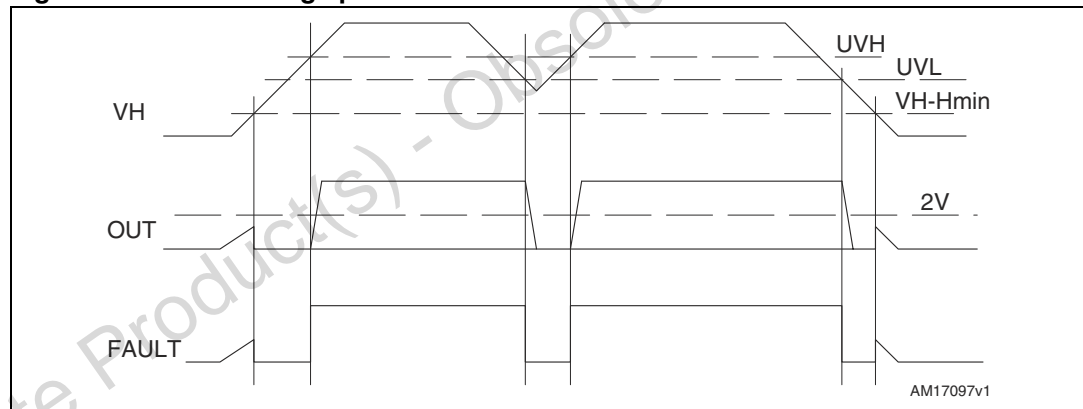

5 Package mechanical data

In order to meet environmental requirements, ST offers these devices in different grades of ECOPACK[®] packages, depending on their level of environmental compliance. ECOPACK[®] specifications, grade definitions and product status are available at: www.st.com. ECOPACK[®] is an ST trademark.

Please refer to dedicated technical note TN0107 for mounting instructions.

Table 11. SDIP-18L package mechanical data

Dim.	mm.		
	Min.	Typ.	Max.
A	49.10	49.60	50.10
A1	1.10	1.30	1.50
A2	1.40	1.60	1.80
A3	44.10	44.60	45.10
B	24.00	24.50	25.00
B1	11.25	11.85	12.45
B2	27.10	27.60	28.10
C	5.00	5.40	6.00
C1	6.50	7.00	7.50
C2	10.35	10.85	11.35
e	2.40	2.60	2.80
e1	11.80	12.00	12.20
e2	7.10	7.30	7.50
e3	4.50	4.70	4.90
e4	5.80	6.00	6.20
e5	6.30	6.50	6.70
e6	10.40	10.60	10.80
e7	17.00	17.20	17.40
D		38.00	
D1		5.70	
E		11.80	
E1		2.15	
F	0.85	1.00	1.15
F1	0.35	0.50	0.65
R	1.55	1.75	1.95
T	0.45	0.55	0.65
V	0°		6°

Figure 9. SDIP-18L package drawing (dimensions are in mm.)

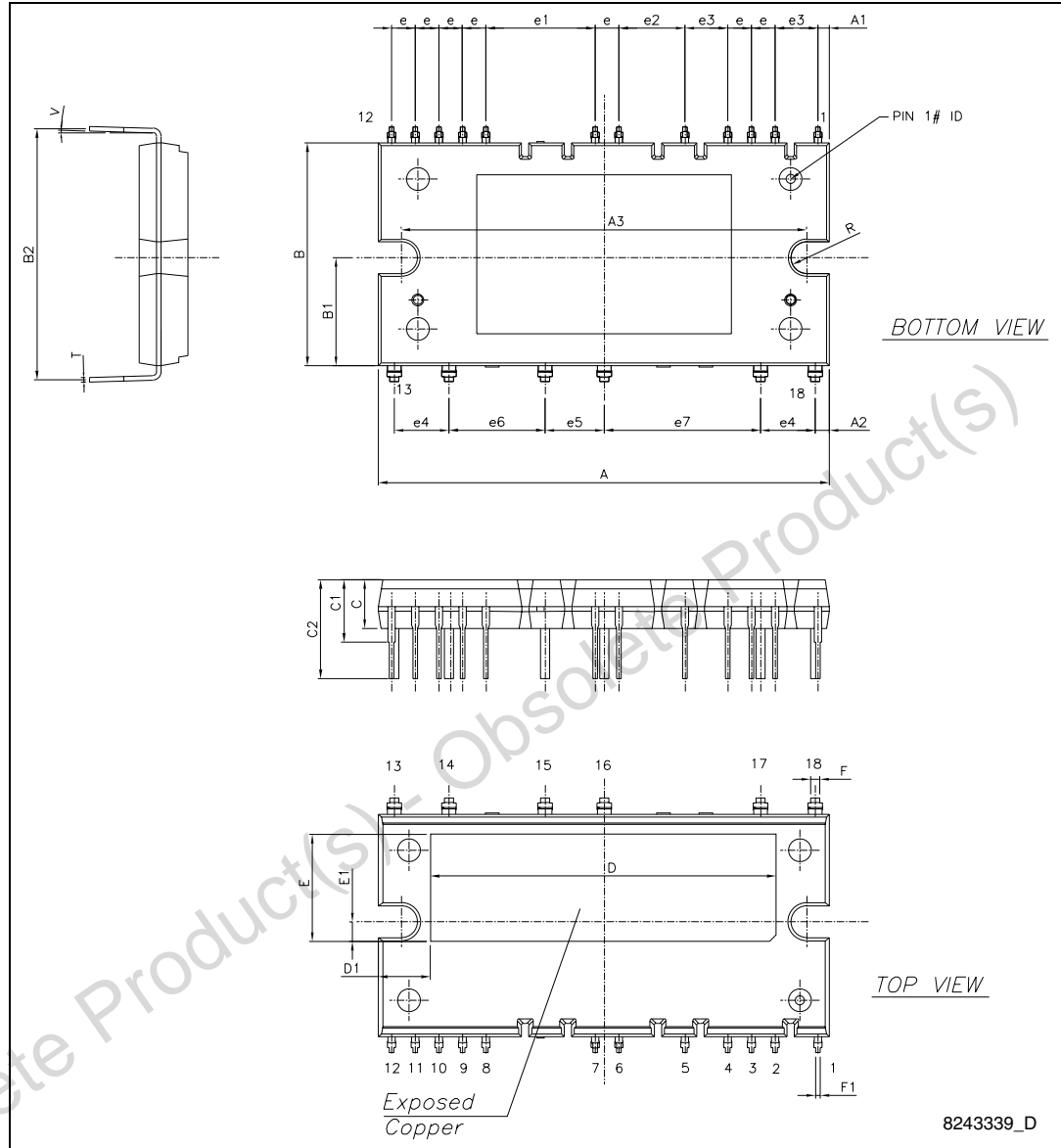

Figure 10. SDIP-18L shipping tube type A (dimensions are in mm.)

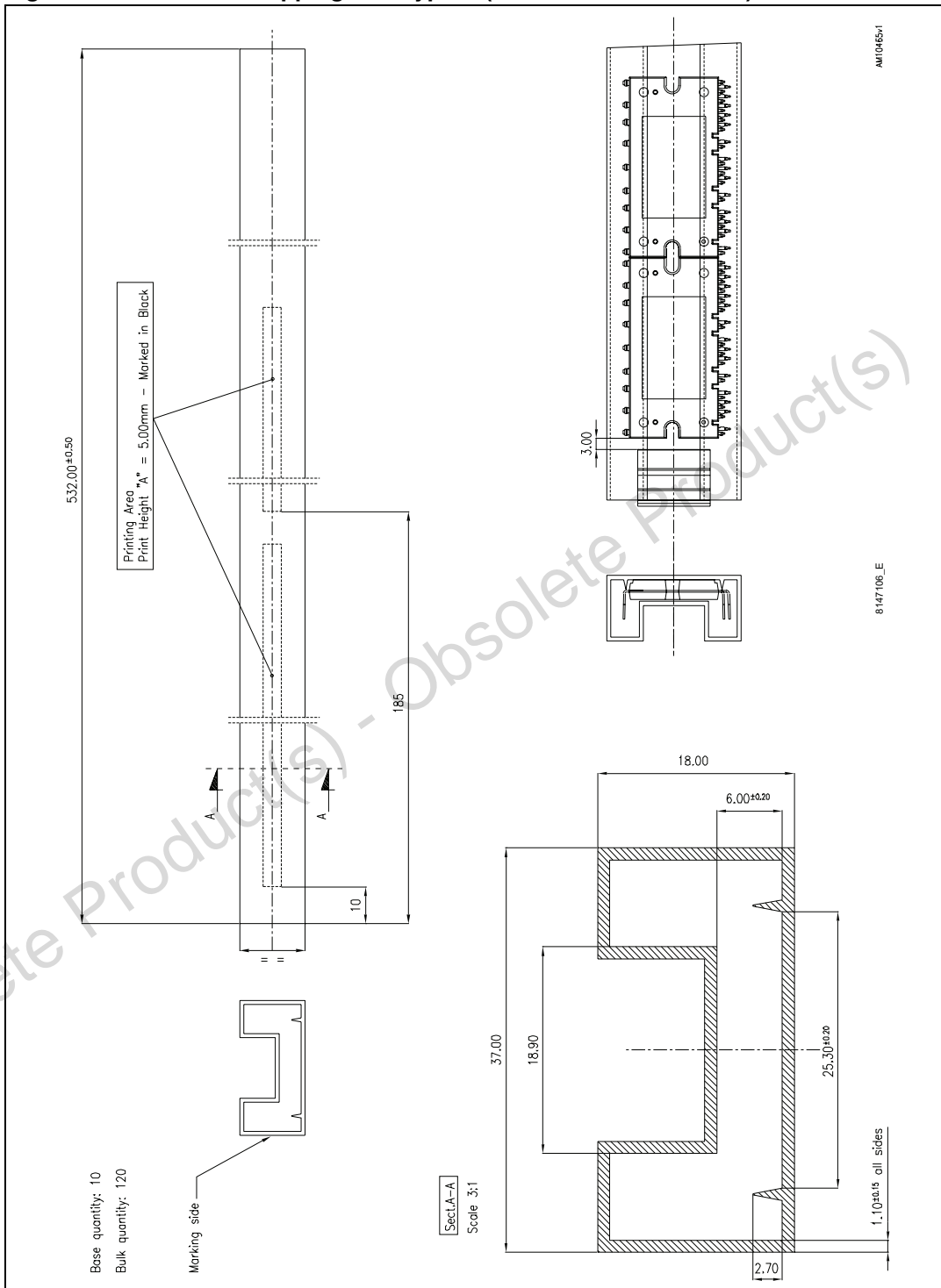
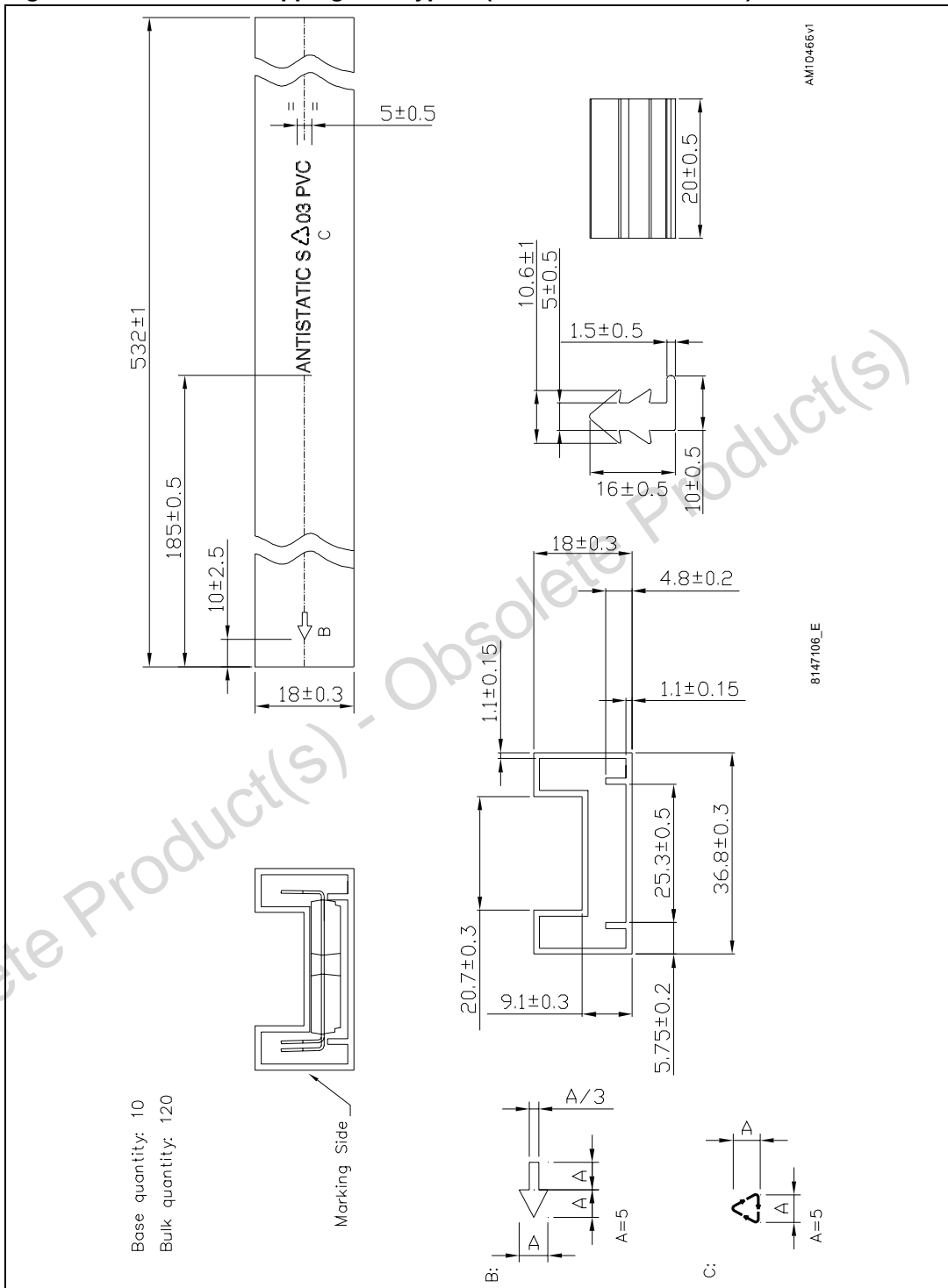

Figure 11. SDIP-18L shipping tube type B (dimensions are in mm.)



6 Revision history

Table 12. Document revision history

Date	Revision	Changes
30-Jan-2012	1	Initial release.
28-Feb-2012	2	Added: $V_{CE(sat)}$ max. value Table 7 on page 7 .
15-Oct-2012	3	Modified: V_F max. value 2.3 V Table 7 on page 7 .
07-Feb-2013	4	Modified: t_{scw} parameter Table 3 on page 5 . Updated: Figure 8 on page 13 .

Obsolete Product(s) - Obsolete Product(s)

Please Read Carefully:

Information in this document is provided solely in connection with ST products. STMicroelectronics NV and its subsidiaries ("ST") reserve the right to make changes, corrections, modifications or improvements, to this document, and the products and services described herein at any time, without notice.

All ST products are sold pursuant to ST's terms and conditions of sale.

Purchasers are solely responsible for the choice, selection and use of the ST products and services described herein, and ST assumes no liability whatsoever relating to the choice, selection or use of the ST products and services described herein.

No license, express or implied, by estoppel or otherwise, to any intellectual property rights is granted under this document. If any part of this document refers to any third party products or services it shall not be deemed a license grant by ST for the use of such third party products or services, or any intellectual property contained therein or considered as a warranty covering the use in any manner whatsoever of such third party products or services or any intellectual property contained therein.

UNLESS OTHERWISE SET FORTH IN ST'S TERMS AND CONDITIONS OF SALE ST DISCLAIMS ANY EXPRESS OR IMPLIED WARRANTY WITH RESPECT TO THE USE AND/OR SALE OF ST PRODUCTS INCLUDING WITHOUT LIMITATION IMPLIED WARRANTIES OF MERCHANTABILITY, FITNESS FOR A PARTICULAR PURPOSE (AND THEIR EQUIVALENTS UNDER THE LAWS OF ANY JURISDICTION), OR INFRINGEMENT OF ANY PATENT, COPYRIGHT OR OTHER INTELLECTUAL PROPERTY RIGHT.

UNLESS EXPRESSLY APPROVED IN WRITING BY TWO AUTHORIZED ST REPRESENTATIVES, ST PRODUCTS ARE NOT RECOMMENDED, AUTHORIZED OR WARRANTED FOR USE IN MILITARY, AIR CRAFT, SPACE, LIFE SAVING, OR LIFE SUSTAINING APPLICATIONS, NOR IN PRODUCTS OR SYSTEMS WHERE FAILURE OR MALFUNCTION MAY RESULT IN PERSONAL INJURY, DEATH, OR SEVERE PROPERTY OR ENVIRONMENTAL DAMAGE. ST PRODUCTS WHICH ARE NOT SPECIFIED AS "AUTOMOTIVE GRADE" MAY ONLY BE USED IN AUTOMOTIVE APPLICATIONS AT USER'S OWN RISK.

Resale of ST products with provisions different from the statements and/or technical features set forth in this document shall immediately void any warranty granted by ST for the ST product or service described herein and shall not create or extend in any manner whatsoever, any liability of ST.

ST and the ST logo are trademarks or registered trademarks of ST in various countries.

Information in this document supersedes and replaces all information previously supplied.

The ST logo is a registered trademark of STMicroelectronics. All other names are the property of their respective owners.

© 2013 STMicroelectronics - All rights reserved

STMicroelectronics group of companies



Australia - Belgium - Brazil - Canada - China - Czech Republic - Finland - France - Germany - Hong Kong - India - Israel - Italy - Japan - Malaysia - Malta - Morocco - Philippines - Singapore - Spain - Sweden - Switzerland - United Kingdom - United States of America

www.st.com



Looking for pricing, stock, or lifecycle information?

Click below to explore more details on WIN SOURCE:

-  [View STGIPL35K120L1 on WIN SOURCE](#)
-  [STMicroelectronics Information](#)

Optimize Your Supply Chain with WIN SOURCE Solutions

-  Global Sourcing Solution
-  Obsolete Management
-  Cost Control Management
-  Shortage Management
-  Alternative Solution
-  Excess Inventory Management