

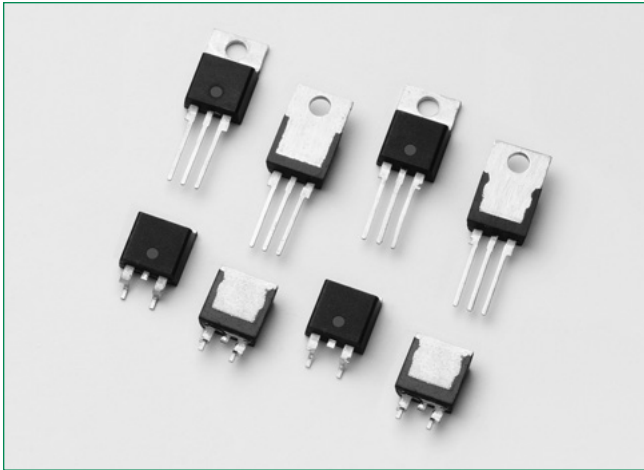


# THE DATASHEET OF S8040NRP



**Sxx40x Series**

RoHS



**Description**

Excellent unidirectional switches for phase control applications such as heating and motor speed controls. Standard phase control SCRs are triggered with few milliamperes of current at less than 1.5V potential.

**Features & Benefits**

- RoHS compliant
- Glass – passivated junctions
- Voltage capability up to 1000 V
- Surge capability up to 520 A

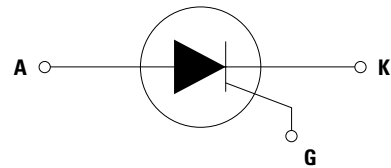
**Main Features**

Symbol	Value	Unit
$I_{T(RMS)}$	40	A
$V_{DRM}/V_{RRM}$	400 to 1000	V
$I_{GT}$	40	mA

**Applications**

Typical applications are AC solid-state switches, industrial power tools, exercise equipment, white goods and commercial appliances.

**Schematic Symbol**



**Absolute Maximum Ratings**

Symbol	Parameter	Test Conditions	Value	Unit
$I_{T(RMS)}$	RMS on-state current	$T_c = 100^\circ\text{C}$	40	A
$I_{T(AV)}$	Average on-state current	$T_c = 100^\circ\text{C}$	25.0	A
$I_{TSM}$	Peak non-repetitive surge current	single half cycle; $f = 50\text{Hz}$ ; $T_J(\text{initial}) = 25^\circ\text{C}$	430	A
		single half cycle; $f = 60\text{Hz}$ ; $T_J(\text{initial}) = 25^\circ\text{C}$	520	
$I^2t$	$I^2t$ Value for fusing	$t_p = 8.3 \text{ ms}$	1122	$\text{A}^2\text{s}$
$di/dt$	Critical rate of rise of on-state current	$f = 60\text{Hz}$ ; $T_J = 125^\circ\text{C}$	175	$\text{A}/\mu\text{s}$
$I_{GM}$	Peak gate current	$T_J = 125^\circ\text{C}$	3.5	A
$P_{G(AV)}$	Average gate power dissipation	$T_J = 125^\circ\text{C}$	0.8	W
$T_{stg}$	Storage temperature range		-40 to 150	$^\circ\text{C}$
$T_J$	Operating junction temperature range		-40 to 125	$^\circ\text{C}$

### Electrical Characteristics ( $T_J = 25^\circ\text{C}$ , unless otherwise specified)

Symbol	Test Conditions		Value	Unit	
$I_{GT}$	$V_D = 12\text{V}; R_L = 30\ \Omega$	MAX.	40	mA	
		MIN.	5		
$V_{GT}$		MAX.	1.5	V	
dv/dt	$V_D = V_{DRM}; \text{gate open}; T_J = 100^\circ\text{C}$	400V	MIN.	650	V/ $\mu\text{s}$
		600V		600	
		800V		500	
	$V_D = V_{DRM}; \text{gate open}; T_J = 125^\circ\text{C}$	1000V		250	
		400V		550	
		600V		500	
$V_{GD}$	$V_D = V_{DRM}; R_L = 3.3\ \text{k}\Omega; T_J = 125^\circ\text{C}$	800V	MIN.	475	
				0.2	
$I_H$	$I_T = 400\text{mA}$ (initial)	MAX.	60	mA	
$t_q$	(1)	MAX.	35	$\mu\text{s}$	
$t_{gt}$	$I_G = 2 \times I_{GT}; \text{PW} = 15\mu\text{s}; I_T = 80\text{A}$	TYP.	2.5	$\mu\text{s}$	

**Note :**

 1.  $I_T = 2\text{A}; t_p = 50\mu\text{s}; dv/dt = 5\text{V}/\mu\text{s}; di/dt = 30\text{A}/\mu\text{s}$ 

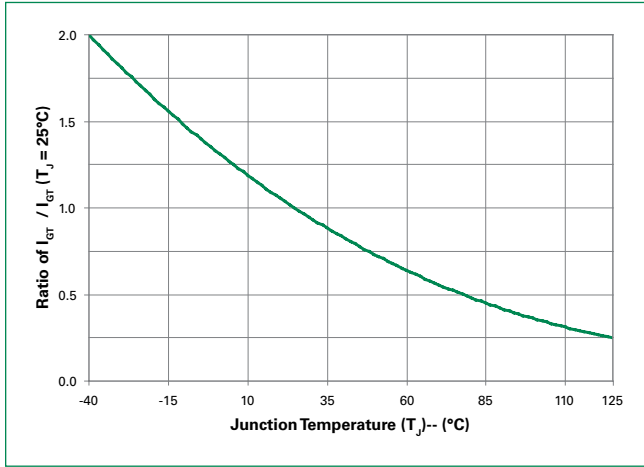
### Static Characteristics

Symbol	Test Conditions		Value	Unit	
$V_{TM}$	$I_T = 80\text{A}; t_p = 380\mu\text{s}$		MAX.	1.8	
$I_{DRM} / I_{RRM}$	$V_{DRM} / V_{RRM}$	$T_J = 25^\circ\text{C}$	MAX.	400 – 600V	10
				800V	20
				1000V	30
		$T_J = 100^\circ\text{C}$		400 – 600V	1000
				800V	1500
				1000V	5000
		$T_J = 125^\circ\text{C}$		400 – 600V	2000
				800V	3000

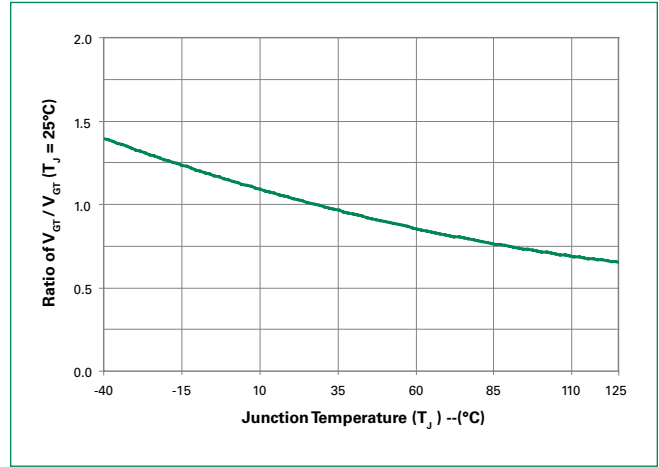
### Thermal Resistances

Symbol	Parameter		Value	Unit
$R_{\theta(J-C)}$	Junction to case (AC)	Sxx40R / Sxx40N	0.6	$^\circ\text{C}/\text{W}$
$R_{\theta(J-A)}$	Junction to ambient	Sxx40R	40	$^\circ\text{C}/\text{W}$

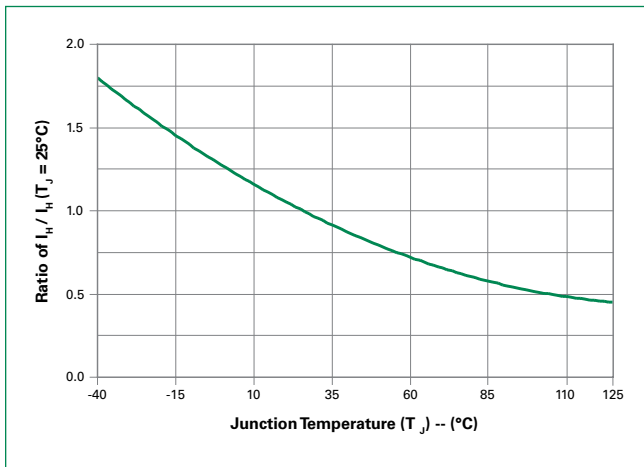
**Figure 1: Normalized DC Gate Trigger Current vs. Junction Temperature**



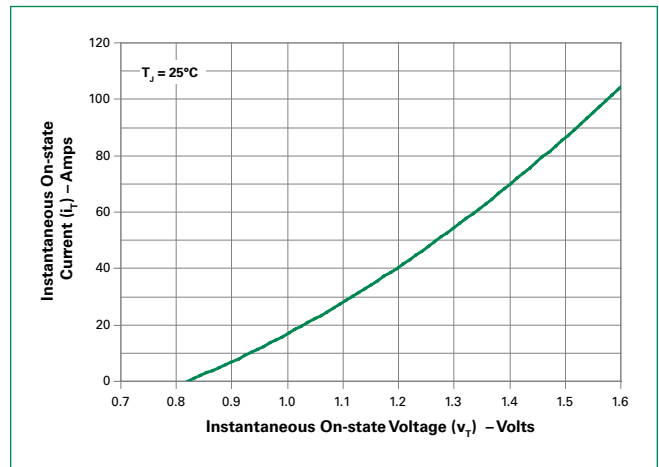
**Figure 2: Normalized DC Gate Trigger Voltage vs. Junction Temperature**



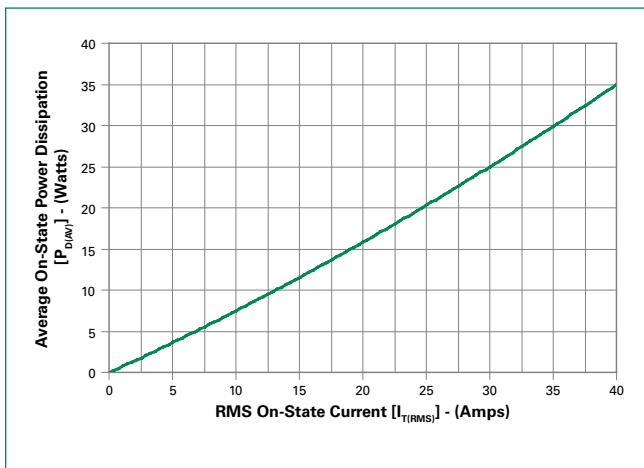
**Figure 3: Normalized DC Holding Current vs. Junction Temperature**



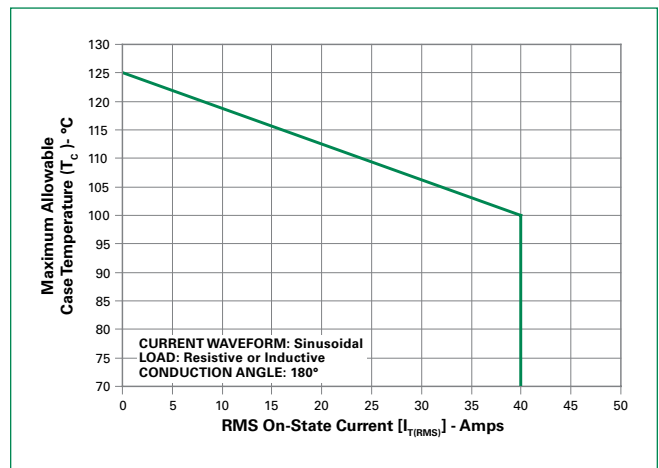
**Figure 4: On-State Current vs. On-State Voltage (Typical)**



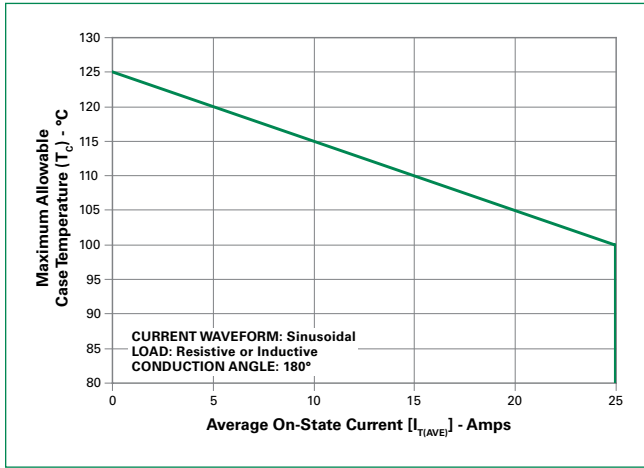
**Figure 5: Power Dissipation (Typical) vs. RMS On-State Current**



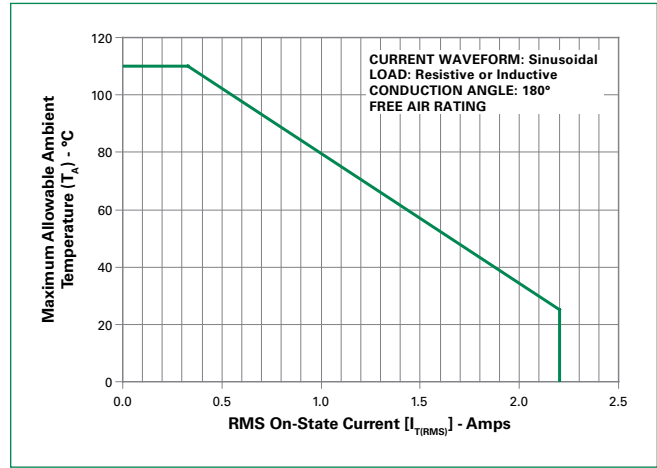
**Figure 6: Maximum Allowable Case Temperature vs. RMS On-State Current**



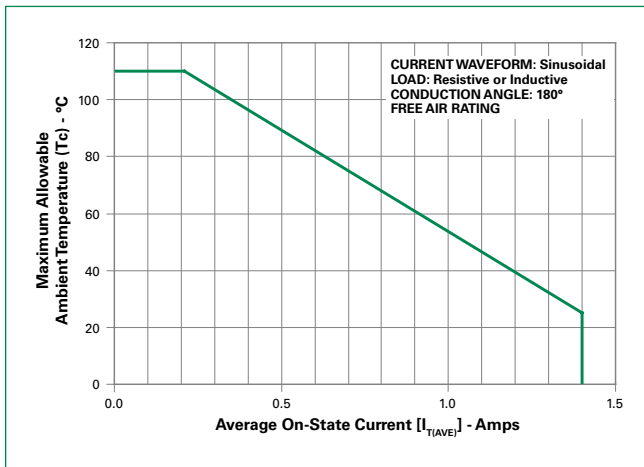
**Figure 7: Maximum Allowable Case Temperature vs. Average On-State Current**



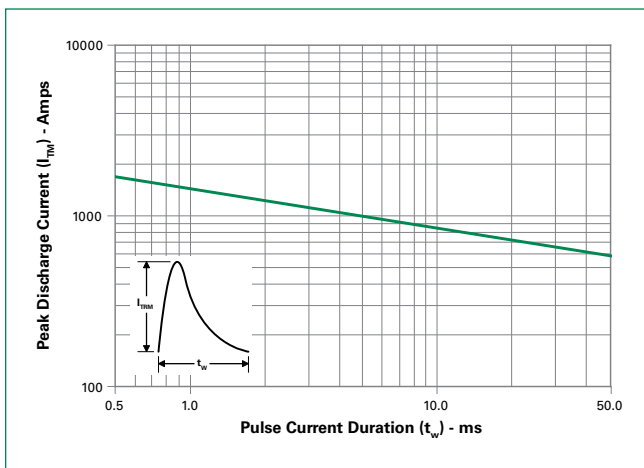
**Figure 8: Maximum Allowable Ambient Temperature vs. RMS On-State Current**



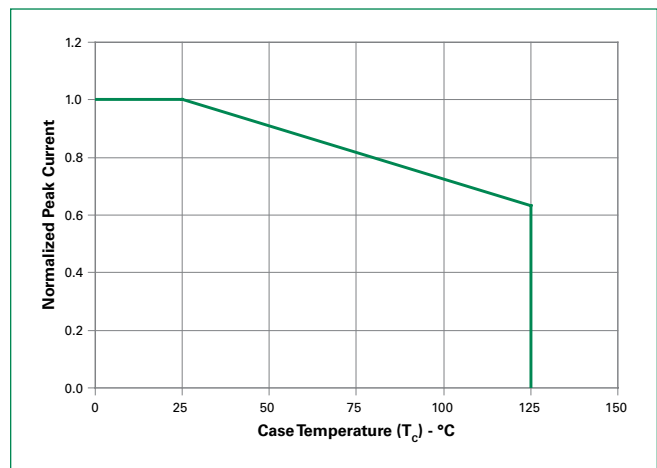
**Figure 9: Maximum Allowable Ambient Temperature vs. Average On-State Current**



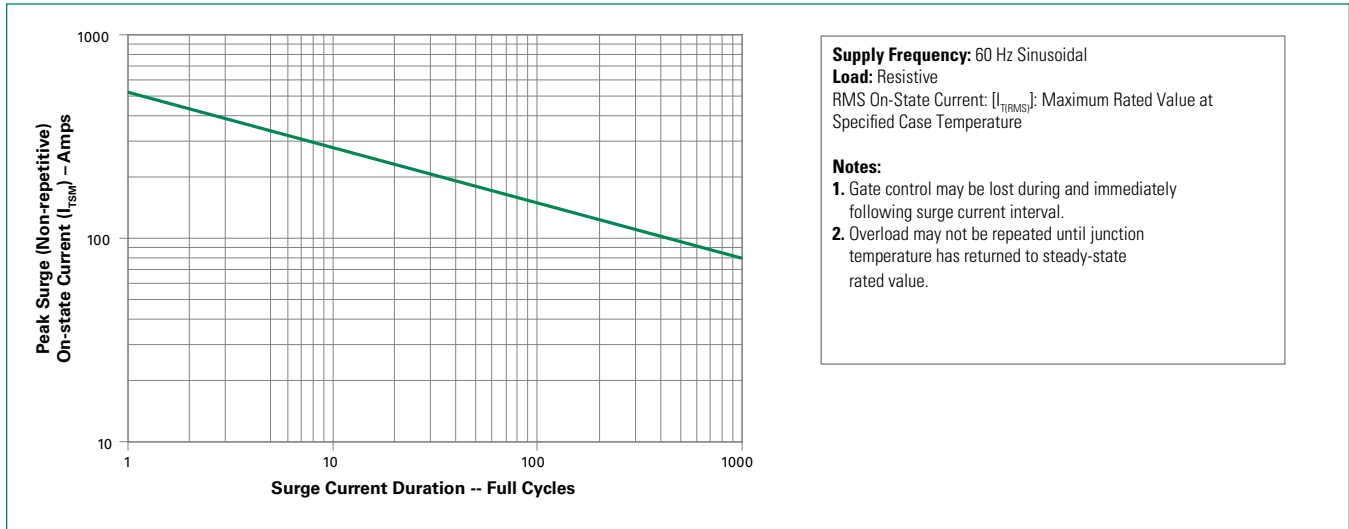
**Figure 10: Peak Capacitor Discharge Current**



**Figure 11: Peak Capacitor Discharge Current Derating**

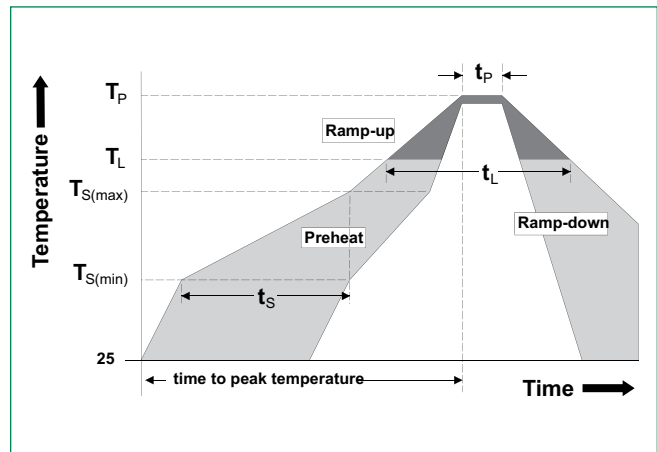


**Figure 12: Surge Peak On-State Current vs. Number of Cycles**



### Soldering Parameters

<b>Reflow Condition</b>	Pb – Free assembly	
<b>Pre Heat</b>	- Temperature Min ( $T_{s(min)}$ )	150°C
	- Temperature Max ( $T_{s(max)}$ )	200°C
	- Time (min to max) ( $t_s$ )	60 – 180 secs
<b>Average ramp up rate (Liquidus Temp) (<math>T_L</math>) to peak</b>		5°C/second max
<b><math>T_{s(max)}</math> to <math>T_L</math> - Ramp-up Rate</b>		5°C/second max
<b>Reflow</b>	- Temperature ( $T_L$ ) (Liquidus)	217°C
	- Time ( $t_r$ )	60 – 150 seconds
<b>Peak Temperature (<math>T_p</math>)</b>		260 <sup>+0/-5</sup> °C
<b>Time within 5°C of actual peak Temperature (<math>t_p</math>)</b>		20 – 40 seconds
<b>Ramp-down Rate</b>		5°C/second max
<b>Time 25°C to peak Temperature (<math>T_p</math>)</b>		8 minutes Max.
<b>Do not exceed</b>		280°C



### Physical Specifications

<b>Terminal Finish</b>	100% Matte Tin-plated
<b>Body Material</b>	UL recognized compound meeting flammability rating V-0.
<b>Lead Material</b>	Copper Alloy

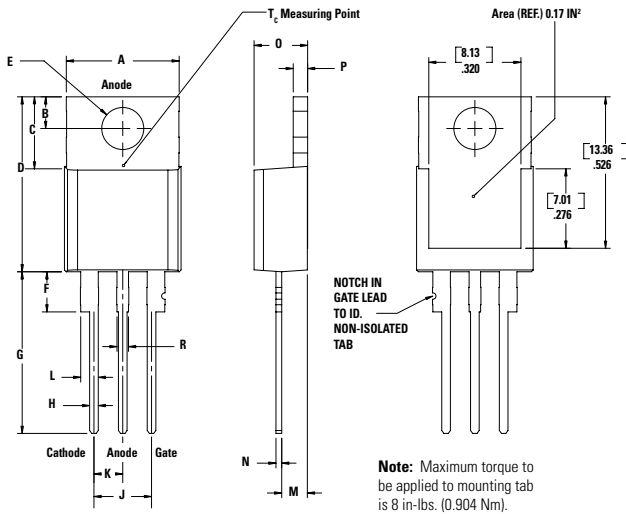
### Design Considerations

Careful selection of the correct component for the application's operating parameters and environment will go a long way toward extending the operating life of the Thyristor. Good design practice should limit the maximum continuous current through the main terminals to 75% of the component rating. Other ways to ensure long life for a power discrete semiconductor are proper heat sinking and selection of voltage ratings for worst case conditions. Overheating, overvoltage (including dv/dt), and surge currents are the main killers of semiconductors. Correct mounting, soldering, and forming of the leads also help protect against component damage.

### Environmental Specifications

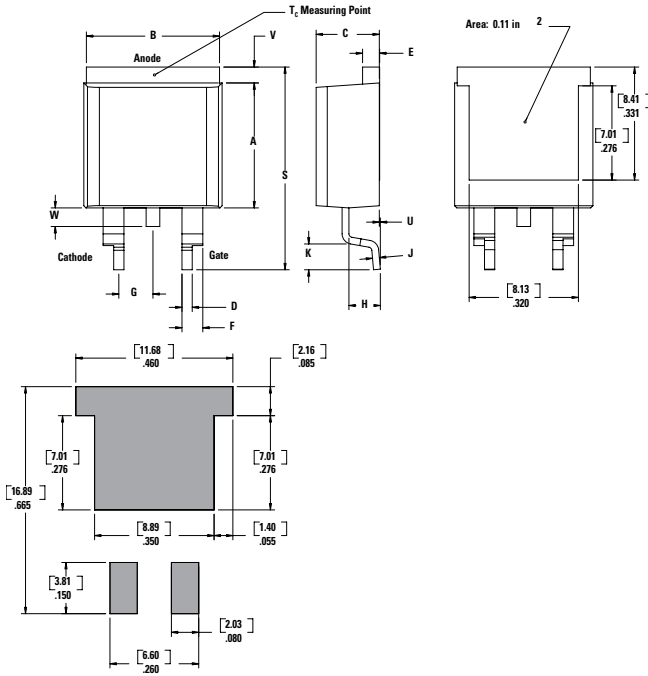
Test	Specifications and Conditions
<b>AC Blocking</b>	MIL-STD-750, M-1040, Cond A Applied Peak AC voltage @ 125°C for 1008 hours
<b>Temperature Cycling</b>	MIL-STD-750, M-1051, 100 cycles; -40°C to +150°C; 15-min dwell-time
<b>Temperature/Humidity</b>	EIA / JEDEC, JESD22-A101 1008 hours; 320V - DC: 85°C; 85% rel humidity
<b>High Temp Storage</b>	MIL-STD-750, M-1031, 1008 hours; 150°C
<b>Low-Temp Storage</b>	1008 hours; -40°C
<b>Resistance to Solder Heat</b>	MIL-STD-750 Method 2031
<b>Solderability</b>	ANSI/J-STD-002, category 3, Test A
<b>Lead Bend</b>	MIL-STD-750, M-2036 Cond E

### Dimensions — TO-220AB (R-Package) — Non-Isolated Mounting Tab Common with Center Lead



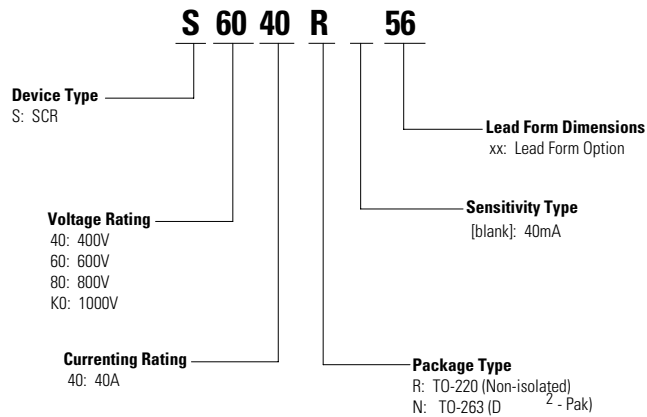
Dimension	Inches		Millimeters	
	Min	Max	Min	Max
<b>A</b>	0.380	0.420	9.65	10.67
<b>B</b>	0.105	0.115	2.67	2.92
<b>C</b>	0.230	0.250	5.84	6.35
<b>D</b>	0.590	0.620	14.99	15.75
<b>E</b>	0.142	0.147	3.61	3.73
<b>F</b>	0.110	0.130	2.79	3.30
<b>G</b>	0.540	0.575	13.72	14.61
<b>H</b>	0.025	0.035	0.64	0.89
<b>J</b>	0.195	0.205	4.95	5.21
<b>K</b>	0.095	0.105	2.41	2.67
<b>L</b>	0.060	0.075	1.52	1.91
<b>M</b>	0.085	0.095	2.16	2.41
<b>N</b>	0.018	0.024	0.46	0.61
<b>O</b>	0.178	0.188	4.52	4.78
<b>P</b>	0.045	0.060	1.14	1.52
<b>R</b>	0.038	0.048	0.97	1.22

### Dimensions – TO- 263 (N-package) — D<sup>2</sup>-Pak Surface Mount



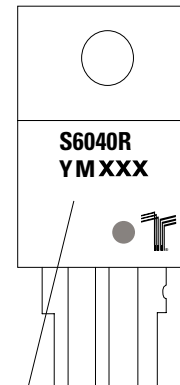
Dimension	Inches		Millimeters	
	Min	Max	Min	Max
A	0.360	0.370	9.14	9.40
B	0.380	0.420	9.65	10.67
C	0.178	0.188	4.52	4.78
D	0.025	0.035	0.63	0.89
E	0.048	0.055	1.22	1.40
F	0.060	0.075	1.52	1.91
G	0.095	0.105	2.41	2.67
H	0.083	0.093	2.11	2.36
J	0.018	0.024	0.46	0.61
K	0.090	0.110	2.29	2.79
S	0.590	0.625	14.99	15.87
V	0.035	0.045	0.89	1.14
U	0.002	0.010	0.05	0.25
W	0.040	0.070	1.02	1.78

### Part Numbering System



### Part Marking System

TO-220 AB - (R Package)  
TO-263 AB - (N Package)



**Date Code Marking**  
Y: Year Code  
M: Month Code  
XXX: Lot Trace Code

### Product Selector

Part Number	Voltage				Gate Sensitivity	Type	Package
	400V	600V	800V	1000V			
Sxx40R	X	X	X	X	40mA	Standard SCR	TO-220R
Sxx40N	X	X	X	X	40mA	Standard SCR	TO-263

Note: xx = Voltage

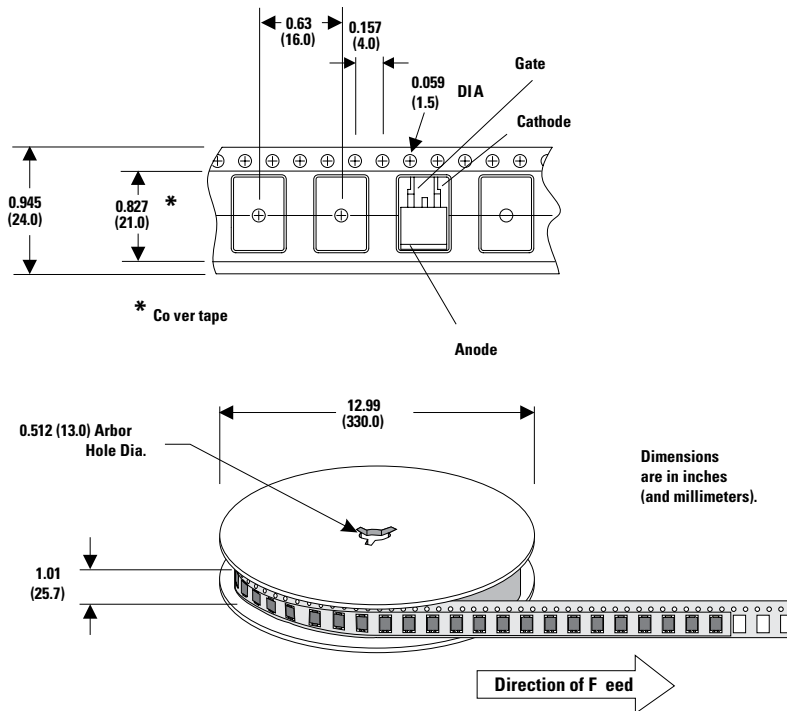
### Packing Options

Part Number	Marking	Weight	Packing Mode	Base Quantity
Sxx40RTP	Sxx40R	2.2g	Tube	1000 (50 per tube)
Sxx40NTP	Sxx40N	1.6g	Tube	1000 (50 per tube)
Sxx40NRP	Sxx40N	1.6g	Embossed Carrier	500

Note: xx = Voltage

### Reel Pack (RP) for TO-263 Embossed Carrier Specifications

Meets all EIA-481-2 Standards



## Looking for pricing, stock, or lifecycle information?

Click below to explore more details on WIN SOURCE:

 [View S8040NRP on WIN SOURCE](#)

 [Littelfuse Inc. Information](#)

## Optimize Your Supply Chain with WIN SOURCE Solutions

-  Global Sourcing Solution
-  Obsolete Management
-  Cost Control Management
-  Shortage Management
-  Alternative Solution
-  Excess Inventory Management