



**THE DATASHEET OF
S4006VS2TP**



Sxx06xSx & Sxx06x Series



Agency Approval

| Agency | Agency File Number |
|--------|--------------------|
| | E71639* |

* - L Package Only

Main Features

| Symbol | Value | Unit |
|-------------------|-------------|------|
| $I_{T(RMS)}$ | 6 | A |
| V_{DRM}/V_{RRM} | 400 to 1000 | V |
| I_{GT} | 0.2 to 15 | mA |

Additional Information



Datasheet



Resources



Samples

Description

This Sxx06x SCR series is ideal for uni-directional switch applications such as phase control, heating, motor speed controls, converters/rectifiers and capacitive discharge ignitions.

These SCRs have a low gate current trigger level of 0.2 to 15 mA at approximately 1.5V, with a sensitive version of this series having a gate trigger current less than 500µA. The sensitive gate SCR version is easily triggered by sense coils, proximity switches, and microprocessors.

Features & Benefits

- Halogen free and RoHS compliant
- Glass – passivated junctions
- Voltage capability up to 1000 V
- Surge capability up to 100 A at 60 Hz half cycle
- L-Package is UL recognized for 2500Vrms

Applications

Typical applications are capacitive discharge systems for strobe lights, nailers, staplers and gas engine ignition. Also, AC control & rectification for power tools, home/ brown goods and white goods appliances and 2-wheeler rectifier/battery regulators.

Internally constructed isolated packages are offered for ease of heat sinking with highest isolation voltage.

Schematic Symbol



Absolute Maximum Ratings — Sensitive SCRs

| Symbol | Parameter | Test Conditions | | Value | Unit |
|--------------|---|--|--------------------------|------------|------------------------|
| $I_{T(RMS)}$ | RMS on-state current | Sxx06LSy | $T_c = 80^\circ\text{C}$ | 6 | A |
| | | Sxx06NSy Sxx06RSy Sxx06DSy Sxx06VSy | $T_c = 95^\circ\text{C}$ | | |
| $I_{T(AV)}$ | Average on-state current | Sxx06LSy | $T_c = 80^\circ\text{C}$ | 3.8 | A |
| | | Sxx06NSy Sxx06RSy Sxx06DSy Sxx06VSy | $T_c = 95^\circ\text{C}$ | | |
| I_{TSM} | Peak non-repetitive surge current | single half cycle; $f = 50\text{Hz}$; $T_J(\text{initial}) = 25^\circ\text{C}$ | | 83 | A |
| | | single half cycle; $f = 60\text{Hz}$; $T_J(\text{initial}) = 25^\circ\text{C}$ | | 100 | |
| I^2t | I^2t Value for fusing | $t_p = 8.3\text{ ms}$ | | 41 | A^2s |
| di/dt | Critical rate of rise of on-state current | $f = 60\text{Hz}$; $T_J = 110^\circ\text{C}$ | | 100 | $\text{A}/\mu\text{s}$ |
| I_{GTM} | Peak gate current | $T_J = 110^\circ\text{C}$ | | 1 | A |
| $P_{G(AV)}$ | Average gate power dissipation | $T_J = 110^\circ\text{C}$ | | 0.1 | W |
| T_{stg} | Storage temperature range | | | -40 to 150 | $^\circ\text{C}$ |
| T_J | Operating junction temperature range | | | -40 to 110 | $^\circ\text{C}$ |

Note: xx = voltage, y = sensitivity

Absolute Maximum Ratings — Standard SCRs

| Symbol | Parameter | Test Conditions | | Value | Unit |
|--------------|---|--|---------------------------|------------|------------------------|
| $I_{T(RMS)}$ | RMS on-state current | Sxx06L | $T_c = 100^\circ\text{C}$ | 6 | A |
| | | Sxx06N Sxx06R Sxx06D Sxx06V | $T_c = 110^\circ\text{C}$ | | |
| $I_{T(AV)}$ | Average on-state current | Sxx06L | $T_c = 100^\circ\text{C}$ | 3.8 | A |
| | | Sxx06N Sxx06R Sxx06D Sxx06V | $T_c = 110^\circ\text{C}$ | | |
| I_{TSM} | Peak non-repetitive surge current | single half cycle; $f = 50\text{Hz}$; $T_J(\text{initial}) = 25^\circ\text{C}$ | | 83 | A |
| | | single half cycle; $f = 60\text{Hz}$; $T_J(\text{initial}) = 25^\circ\text{C}$ | | 100 | |
| I^2t | I^2t value for fusing | $t_p = 8.3\text{ ms}$ | | 41 | A^2s |
| di/dt | Critical rate-of-rise of on-state current | $f = 60\text{Hz}$; $T_J = 125^\circ\text{C}$ | | 100 | $\text{A}/\mu\text{s}$ |
| I_{GTM} | Peak gate current | $T_J = 125^\circ\text{C}$ | | 2 | A |
| $P_{G(AV)}$ | Average gate power dissipation | $T_J = 125^\circ\text{C}$ | | 0.5 | W |
| T_{stg} | Storage temperature range | | | -40 to 150 | $^\circ\text{C}$ |
| T_J | Operating junction temperature range | | | -40 to 125 | $^\circ\text{C}$ |

Note: xx = voltage

Electrical Characteristics ($T_J = 25^\circ\text{C}$, unless otherwise specified) — Sensitive SCRs

| Symbol | Test Conditions | | Value | | Unit |
|-----------|---|------|----------|----------|------------------|
| | | | Sxx06xS2 | Sxx06xS3 | |
| I_{GT} | $V_D = 6V$ $R_L = 100\ \Omega$ | MAX. | 200 | 500 | μA |
| V_{GT} | $V_D = 6V$ $R_L = 100\ \Omega$ | MAX. | 0.8 | | V |
| dv/dt | $V_D = V_{DRM}$; $R_{GK} = 1\text{k}\Omega$; $T_J = 110^\circ\text{C}$ | TYP. | 8 | | V/ μs |
| V_{GD} | $V_D = V_{DRM}$ $R_L = 3.3\ \text{k}\Omega$ $T_J = 110^\circ\text{C}$ | MIN. | 0.2 | | V |
| V_{GRM} | $I_{GR} = 10\ \mu\text{A}$ | MIN. | 6 | | V |
| I_H | $I_T = 20\text{mA}$ (initial) | MAX. | 6 | 8 | mA |
| t_q | $I_T = 2\text{A}$; $t_p = 50\ \mu\text{s}$; dv/dt=5V/ μs ; di/dt=-30A/ μs | MAX. | 50 | 45 | μs |
| t_{gt} | $I_G = 2 \times I_{GT}$ PW = 15 μs $I_T = 12\text{A}$ | TYP. | 4 | 5 | μs |

Note: xx = voltage, x = package

Electrical Characteristics ($T_J = 25^\circ\text{C}$, unless otherwise specified) — Standard SCRs

| Symbol | Test Conditions | | | Value | Unit |
|----------|---|-------|------|--------|------------------|
| | | | | Sxx06x | |
| I_{GT} | $V_D = 12V$ $R_L = 60\ \Omega$ | | MAX. | 15 | mA |
| V_{GT} | $V_D = 12V$ $R_L = 60\ \Omega$ | | MAX. | 1.5 | V |
| dv/dt | $V_D = V_{DRM}$; gate open; $T_J = 100^\circ\text{C}$ | 400V | MIN. | 350 | V/ μs |
| | | 600V | | 300 | |
| | | 800V | | 250 | |
| | | 1000V | | 100 | |
| | $V_D = V_{DRM}$; gate open; $T_J = 125^\circ\text{C}$ | 400V | | 250 | |
| | | 600V | | 225 | |
| | | 800V | | 200 | |
| | | | | | |
| V_{GD} | $V_D = V_{DRM}$ $R_L = 3.3\ \text{k}\Omega$ $T_J = 125^\circ\text{C}$ | | MIN. | 0.2 | V |
| I_H | $I_T = 200\text{mA}$ (initial) | | MAX. | 30 | mA |
| t_q | $I_T = 2\text{A}$; $t_p = 50\ \mu\text{s}$; dv/dt=5V/ μs ; di/dt=-30A/ μs | | MAX. | 35 | μs |
| t_{gt} | $I_G = 2 \times I_{GT}$ PW = 15 μs $I_T = 12\text{A}$ | | TYP. | 2 | μs |

Note: xx = voltage, x = package

Static Characteristics

| Symbol | Test Conditions | | Value | Unit | |
|---------------------|------------------------------|---------------------|------------|----------|------|
| V_{TM} | $I_T = 12A; t_p = 380 \mu s$ | | MAX. | 1.6 V | |
| I_{DRM} / I_{RRM} | Sxx06xyy | $T_J = 25^\circ C$ | 400 – 600V | MAX. | 5 |
| | | $T_J = 110^\circ C$ | 400 – 600V | | 250 |
| | Sxx06x | $T_J = 25^\circ C$ | 400 – 800V | | 10 |
| | | | 1000V | | 20 |
| | | $T_J = 100^\circ C$ | 400 – 800V | | 200 |
| | | | 1000V | | 3000 |
| | $T_J = 125^\circ C$ | 400 – 800V | 500 | | |

Note: xx = voltage, x = package, yy = sensitivity

Thermal Resistances

| Symbol | Parameter | Value | Unit | |
|-------------------|-----------------------|---------------------|------|--------------|
| $R_{\theta(J-C)}$ | Junction to case (AC) | Sxx06RSy / Sxx06NSy | 2.6 | $^\circ C/W$ |
| | | Sxx06LSy | 4.3 | |
| | | Sxx06VSY | 2.4 | |
| | | Sxx06DSy | 1.8 | |
| | | Sxx06R / Sxx06N | 2.5 | |
| | | Sxx06L | 4.0 | |
| | | Sxx06V | 2.3 | |
| | | Sxx06D | 1.7 | |
| $R_{\theta(J-A)}$ | Junction to ambient | Sxx06RSy | 40 | $^\circ C/W$ |
| | | Sxx06LSy | 65 | |
| | | Sxx06VSY | 85 | |
| | | Sxx06R | 40 | |
| | | Sxx06L | 50 | |
| | | Sxx06V | 70 | |

Note: xx = voltage, y = sensitivity

Figure 1: Normalized DC Gate Trigger Current vs. Junction Temperature (Sensitive SCR)

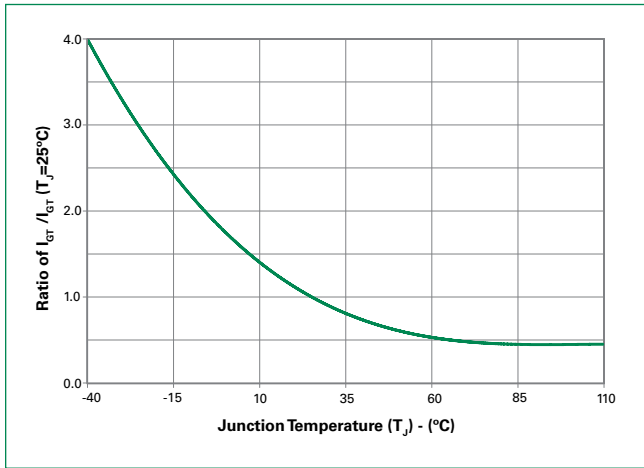

Figure 2: Normalized DC Gate Trigger Current vs. Junction Temperature (Standard SCR)

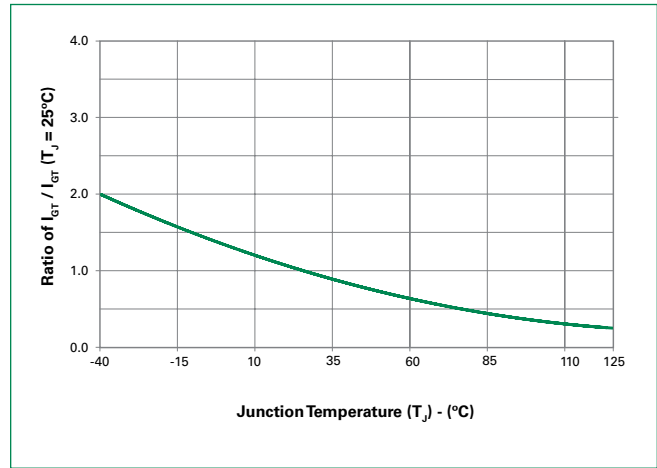

Figure 3: Normalized DC Gate Trigger Voltage vs. Junction Temperature

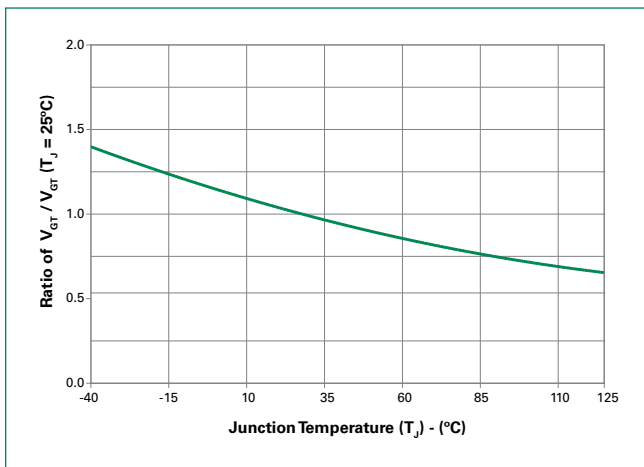

Figure 4: Normalized DC Holding Current vs. Junction Temperature

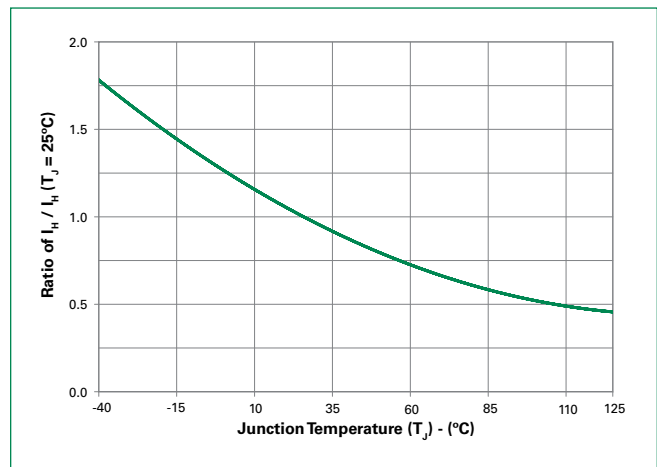

Figure 5: On-State Current vs. On-State Voltage (Typical)

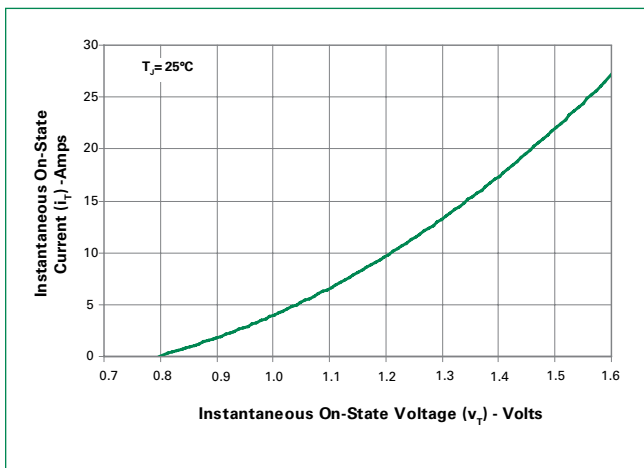

Figure 6: Power Dissipation (Typical) vs. RMS On-State Current

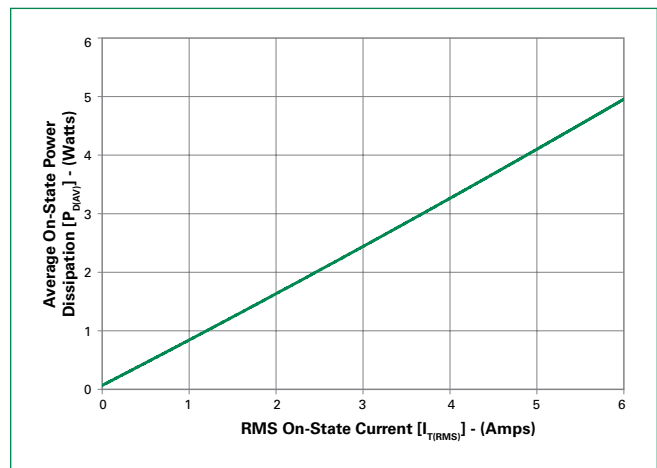

Figure 7: Maximum Allowable Case Temperature vs. RMS On-State Current

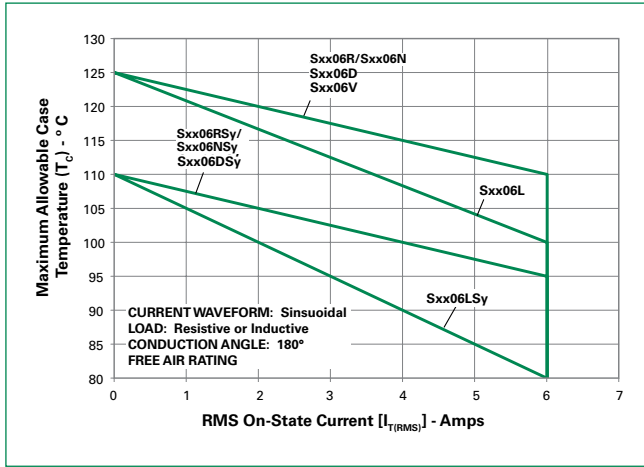

Figure 8: Maximum Allowable Case Temperature vs. Average On-State Current

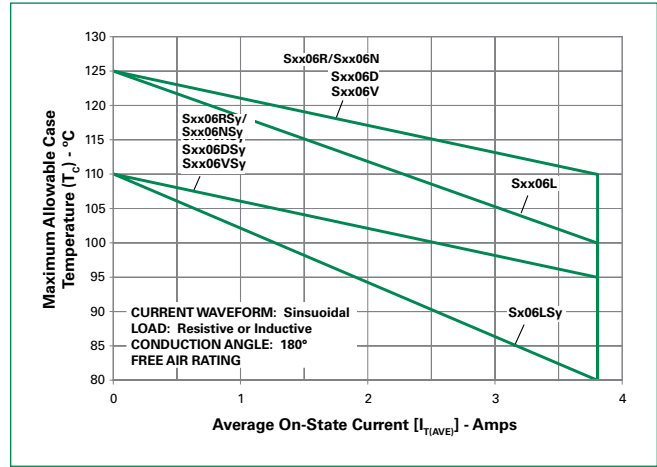

Figure 9: Maximum Allowable Ambient Temperature vs. RMS On-State Current

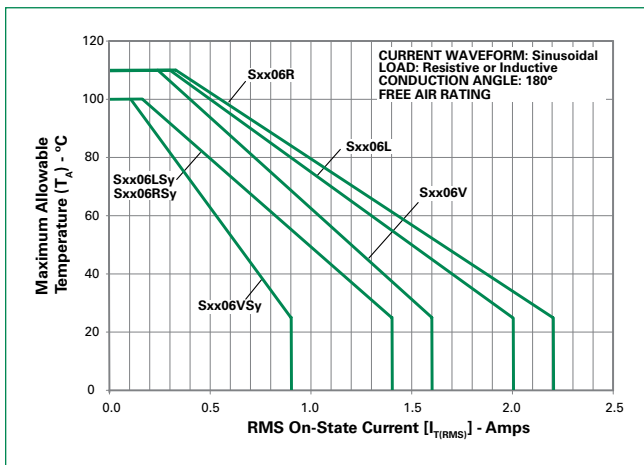
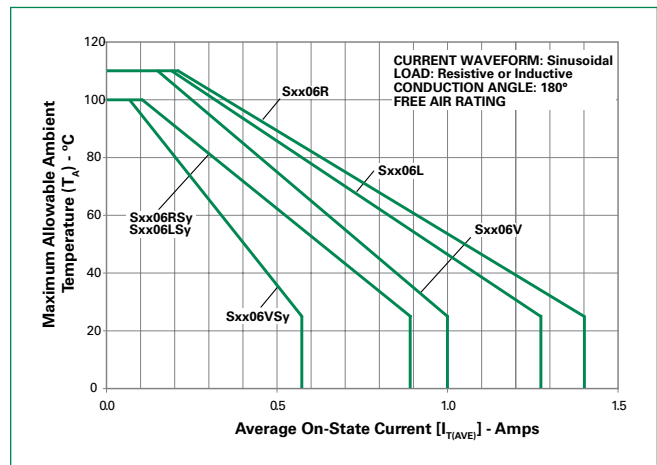

Figure 10: Maximum Allowable Ambient Temperature vs. Average On-State Current



Note: xx = voltage, y = sensitivity

Figure 11: Peak Capacitor Discharge Current



Figure 12: Peak Capacitor Discharge Current Derating



Figure 13-1: Typical DC Gate Trigger Current with R_{GK} vs. Junction Temperature for S6008DS2



Figure 13-2: Typical DC Gate Trigger Current with R_{GK} vs. Junction Temperature for SS6008DS3



Figure 14-1: Typical DC Holding Current with R_{GK} vs. Junction Temperature for S6008DS2



Figure 14-2: Typical DC Holding Current with R_{GK} vs. Junction Temperature for SS6008DS3



Figure 15-1: Typical Static dv/dt with R_{GK} vs. Junction Temperature for S6008DS2



Figure 15-2: Typical Static dv/dt with R_{GK} vs. Junction Temperature for SS6008DS3



Figure 16-1: Typical Static dv/dt with R_{GK} vs. Junction Temperature for S6008DS2



Figure 16-2 Typical Static dv/dt with R_{GK} vs. Junction Temperature for SS6008DS3

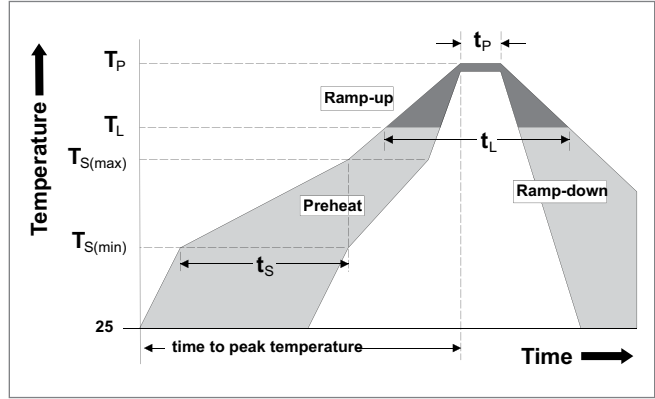

Figure 17: Surge Peak On-State Current vs. Number of Cycles



Soldering Parameters

| | | |
|--|------------------------------------|-------------------------|
| Reflow Condition | | Pb – Free assembly |
| Pre Heat | - Temperature Min ($T_{s(min)}$) | 150°C |
| | - Temperature Max ($T_{s(max)}$) | 200°C |
| | - Time (min to max) (t_s) | 60 – 180 secs |
| Average ramp up rate (Liquidus Temp) (T_L) to peak | | 5°C/second max |
| $T_{s(max)}$ to T_L - Ramp-up Rate | | 5°C/second max |
| Reflow | - Temperature (T_L) (Liquidus) | 217°C |
| | - Temperature (t_L) | 60 – 150 seconds |
| Peak Temperature (T_p) | | 260 ^{+0/-5} °C |
| Time within 5°C of actual peak Temperature (t_p) | | 20 – 40 seconds |
| Ramp-down Rate | | 5°C/second max |
| Time 25°C to peak Temperature (T_p) | | 8 minutes Max. |
| Do not exceed | | 280°C |



Physical Specifications

| | |
|------------------------|---|
| Terminal Finish | 100% Matte Tin-plated |
| Body Material | UL recognized epoxy meeting flammability rating 94V-0 |
| Lead Material | Copper Alloy |

Design Considerations

Careful selection of the correct component for the application's operating parameters and environment will go a long way toward extending the operating life of the Thyristor. Good design practice should limit the maximum continuous current through the main terminals to 75% of the component rating. Other ways to ensure long life for a power discrete semiconductor are proper heat sinking and selection of voltage ratings for worst case conditions. Overheating, overvoltage (including dv/dt), and surge currents are the main killers of semiconductors. Correct mounting, soldering, and forming of the leads also help protect against component damage.

Environmental Specifications

| Test | Specifications and Conditions |
|----------------------------------|--|
| AC Blocking | MIL-STD-750, M-1040, Cond A Applied Peak AC voltage @ 125°C for 1008 hours |
| Temperature Cycling | MIL-STD-750, M-1051, 100 cycles; -40°C to +150°C; 15-min dwell-time |
| Temperature/Humidity | EIA / JEDEC, JESD22-A101 1008 hours; 320V - DC: 85°C; 85% rel humidity |
| High Temp Storage | MIL-STD-750, M-1031, 1008 hours; 150°C |
| Low-Temp Storage | 1008 hours; -40°C |
| Resistance to Solder Heat | MIL-STD-750 Method 2031 |
| Solderability | ANSI/J-STD-002, category 3, Test A |
| Lead Bend | MIL-STD-750, M-2036 Cond E |

Product Selector

| Part Number | Voltage | | | | Gate Sensitivity | Type | Package |
|-------------|---------|------|------|-------|------------------|---------------|---------|
| | 400V | 600V | 800V | 1000V | | | |
| Sxx06RS2 | X | X | - | - | 0.2mA | Sensitive SCR | TO-220R |
| Sxx06LS2 | X | X | - | - | 0.2mA | Sensitive SCR | TO-220L |
| Sxx06VS2 | X | X | - | - | 0.2mA | Sensitive SCR | TO-251 |
| Sxx06DS2 | X | X | - | - | 0.2mA | Sensitive SCR | TO-252 |
| Sxx06RS3 | X | X | - | - | 0.5mA | Sensitive SCR | TO-220R |
| Sxx06LS3 | X | X | - | - | 0.5mA | Sensitive SCR | TO-220L |
| Sxx06VS3 | X | X | - | - | 0.5mA | Sensitive SCR | TO-251 |
| Sxx06DS3 | X | X | - | - | 0.5mA | Sensitive SCR | TO-252 |
| Sxx06R | X | X | X | X | 15mA | Standard SCR | TO-220R |
| Sxx06L | X | X | X | X | 15mA | Standard SCR | TO-220L |
| Sxx06V | X | X | X | X | 15mA | Standard SCR | TO-251 |
| Sxx06D | X | X | X | X | 15mA | Standard SCR | TO-252 |

Note: xx = voltage

Dimensions – TO-251AA (V/I-Package) – V/I-PAK Through Hole



| Dimension | Inches | | | Millimeters | | |
|-----------|--------|-------|-------|-------------|------|------|
| | Min | Typ | Max | Min | Typ | Max |
| A | 0.037 | 0.040 | 0.043 | 0.94 | 1.01 | 1.09 |
| B | 0.235 | 0.242 | 0.245 | 5.97 | 6.15 | 6.22 |
| C | 0.350 | 0.361 | 0.375 | 8.89 | 9.18 | 9.53 |
| D | 0.205 | 0.208 | 0.213 | 5.21 | 5.29 | 5.41 |
| E | 0.255 | 0.262 | 0.265 | 6.48 | 6.66 | 6.73 |
| F | 0.027 | 0.031 | 0.033 | 0.69 | 0.80 | 0.84 |
| G | 0.087 | 0.090 | 0.093 | 2.21 | 2.28 | 2.36 |
| H | 0.085 | 0.092 | 0.095 | 2.16 | 2.34 | 2.41 |
| I | 0.176 | 0.180 | 0.184 | 4.47 | 4.57 | 4.67 |
| J | 0.018 | 0.020 | 0.023 | 0.46 | 0.51 | 0.58 |
| K | 0.035 | 0.037 | 0.039 | 0.90 | 0.95 | 1.00 |
| L | 0.018 | 0.020 | 0.023 | 0.46 | 0.52 | 0.58 |
| P | 0.042 | 0.047 | 0.052 | 1.06 | 1.20 | 1.32 |
| Q | 0.034 | 0.039 | 0.044 | 0.86 | 1.00 | 1.11 |
| R | 0.034 | 0.039 | 0.044 | 0.86 | 1.00 | 1.11 |
| S | 0.074 | 0.079 | 0.084 | 1.86 | 2.00 | 2.11 |

Dimensions – TO-252AA (D-Package) – D-PAK Surface Mount



| Dimension | Inches | | | Millimeters | | |
|-----------|--------|-------|-------|-------------|------|------|
| | Min | Typ | Max | Min | Typ | Max |
| A | 0.037 | 0.040 | 0.043 | 0.94 | 1.01 | 1.09 |
| B | 0.235 | 0.243 | 0.245 | 5.97 | 6.16 | 6.22 |
| C | 0.106 | 0.108 | 0.113 | 2.69 | 2.74 | 2.87 |
| D | 0.205 | 0.208 | 0.213 | 5.21 | 5.29 | 5.41 |
| E | 0.255 | 0.262 | 0.265 | 6.48 | 6.65 | 6.73 |
| F | 0.027 | 0.031 | 0.033 | 0.69 | 0.80 | 0.84 |
| G | 0.087 | 0.090 | 0.093 | 2.21 | 2.28 | 2.36 |
| H | 0.085 | 0.092 | 0.095 | 2.16 | 2.33 | 2.41 |
| I | 0.176 | 0.179 | 0.184 | 4.47 | 4.55 | 4.67 |
| J | 0.018 | 0.020 | 0.023 | 0.46 | 0.51 | 0.58 |
| K | 0.035 | 0.037 | 0.039 | 0.90 | 0.95 | 1.00 |
| L | 0.018 | 0.020 | 0.023 | 0.46 | 0.51 | 0.58 |
| M | 0.000 | 0.000 | 0.004 | 0.00 | 0.00 | 0.10 |
| N | 0.021 | 0.026 | 0.027 | 0.53 | 0.67 | 0.69 |
| O | 0° | 0° | 5° | 0° | 0° | 5° |
| P | 0.042 | 0.047 | 0.052 | 1.06 | 1.20 | 1.32 |
| Q | 0.034 | 0.039 | 0.044 | 0.86 | 1.00 | 1.11 |

Dimensions — TO-220AB (R-Package) — Non-Isolated Mounting Tab Common with Center Lead

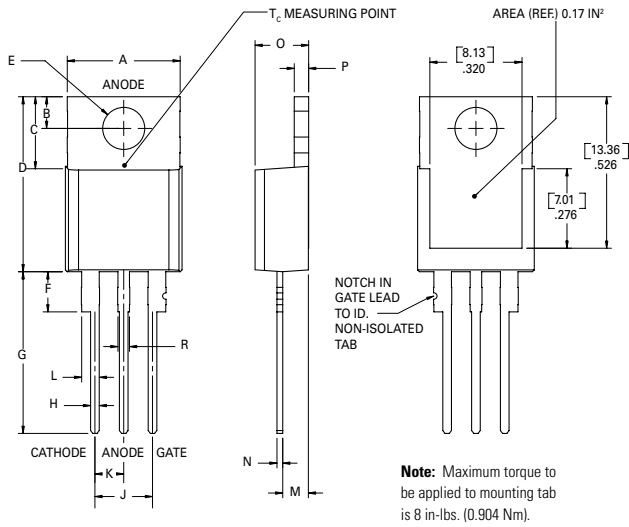

| Dimension | Inches | | Millimeters | |
|-----------|--------|-------|-------------|-------|
| | Min | Max | Min | Max |
| A | 0.380 | 0.420 | 9.65 | 10.67 |
| B | 0.105 | 0.115 | 2.67 | 2.92 |
| C | 0.230 | 0.250 | 5.84 | 6.35 |
| D | 0.590 | 0.620 | 14.99 | 15.75 |
| E | 0.142 | 0.147 | 3.61 | 3.73 |
| F | 0.110 | 0.130 | 2.79 | 3.30 |
| G | 0.540 | 0.575 | 13.72 | 14.61 |
| H | 0.025 | 0.035 | 0.64 | 0.89 |
| J | 0.195 | 0.205 | 4.95 | 5.21 |
| K | 0.095 | 0.105 | 2.41 | 2.67 |
| L | 0.060 | 0.075 | 1.52 | 1.91 |
| M | 0.085 | 0.095 | 2.16 | 2.41 |
| N | 0.018 | 0.024 | 0.46 | 0.61 |
| O | 0.178 | 0.188 | 4.52 | 4.78 |
| P | 0.045 | 0.060 | 1.14 | 1.52 |
| R | 0.038 | 0.048 | 0.97 | 1.22 |

Dimensions — TO-220AB (L-Package) — Isolated Mounting Tab



| Dimension | Inches | | Millimeters | |
|-----------|--------|-------|-------------|-------|
| | Min | Max | Min | Max |
| A | 0.380 | 0.420 | 9.65 | 10.67 |
| B | 0.105 | 0.115 | 2.67 | 2.92 |
| C | 0.230 | 0.250 | 5.84 | 6.35 |
| D | 0.590 | 0.620 | 14.99 | 15.75 |
| E | 0.142 | 0.147 | 3.61 | 3.73 |
| F | 0.110 | 0.130 | 2.79 | 3.30 |
| G | 0.540 | 0.575 | 13.72 | 14.61 |
| H | 0.025 | 0.035 | 0.64 | 0.89 |
| J | 0.195 | 0.205 | 4.95 | 5.21 |
| K | 0.095 | 0.105 | 2.41 | 2.67 |
| L | 0.060 | 0.075 | 1.52 | 1.91 |
| M | 0.085 | 0.095 | 2.16 | 2.41 |
| N | 0.018 | 0.024 | 0.46 | 0.61 |
| O | 0.178 | 0.188 | 4.52 | 4.78 |
| P | 0.045 | 0.060 | 1.14 | 1.52 |
| R | 0.038 | 0.048 | 0.97 | 1.22 |

Dimensions — TO-263 (N Package) — D²Pak Surface Mount



| Dimension | Inches | | Millimeters | |
|-----------|--------|-------|-------------|-------|
| | Min | Max | Min | Max |
| A | 0.360 | 0.370 | 9.14 | 9.40 |
| B | 0.380 | 0.420 | 9.65 | 10.67 |
| C | 0.178 | 0.188 | 4.52 | 4.78 |
| D | 0.025 | 0.035 | 0.64 | 0.89 |
| E | 0.045 | 0.060 | 1.14 | 1.52 |
| F | 0.060 | 0.075 | 1.52 | 1.91 |
| G | 0.095 | 0.105 | 2.41 | 2.67 |
| H | 0.092 | 0.102 | 2.34 | 2.59 |
| J | 0.018 | 0.024 | 0.46 | 0.61 |
| K | 0.090 | 0.110 | 2.29 | 2.79 |
| S | 0.590 | 0.625 | 14.99 | 15.88 |
| V | 0.035 | 0.045 | 0.89 | 1.14 |
| U | 0.002 | 0.010 | 0.05 | 0.25 |
| W | 0.040 | 0.070 | 1.02 | 1.78 |

Packing Options

| Part Number | Marking | Weight | Packing Mode | Base Quantity |
|--------------|------------|--------|------------------|--------------------|
| Sxx06L/RyyTP | Sxx06L/Ryy | 2.2 g | Tube | 1000 (50 per tube) |
| Sxx06DyyTP | Sxx06Dyy | 0.3 g | Tube | 750 (75 per tube) |
| Sxx06DyyRP | Sxx06Dyy | 0.3 g | Embossed Carrier | 2500 |
| Sxx06VyyTP | Sxx06Vyy | 0.4 g | Tube | 750 (75 per tube) |
| Sxx06L/RTP | Sxx06L/R | 2.2 g | Tube | 1000 (50 per tube) |
| Sxx06DTP | Sxx06D | 0.3 g | Tube | 750 (75 per tube) |
| Sxx06DRP | Sxx06D | 0.3 g | Embossed Carrier | 2500 |
| Sxx06VTP | Sxx06V | 0.4 g | Tube | 750 (75 per tube) |
| Sxx06NyyRP | Sxx6Nyy | 1.6g | Embossed Carrier | 500 |
| Sxx06NyyTP | Sxx6Nyy | 1.6g | Tube | 1000 (50 per tube) |
| Sxx06NRP | Sxx6N | 1.6g | Embossed Carrier | 500 |
| Sxx06NTP | Sxx6N | 1.6g | Tube | 1000 (50 per tube) |

Note: xx = Voltage/10; yy = Sensitivity

TO-252 Embossed Carrier Reel Pack (RP) Specs

Meets all EIA-481-2 Standards

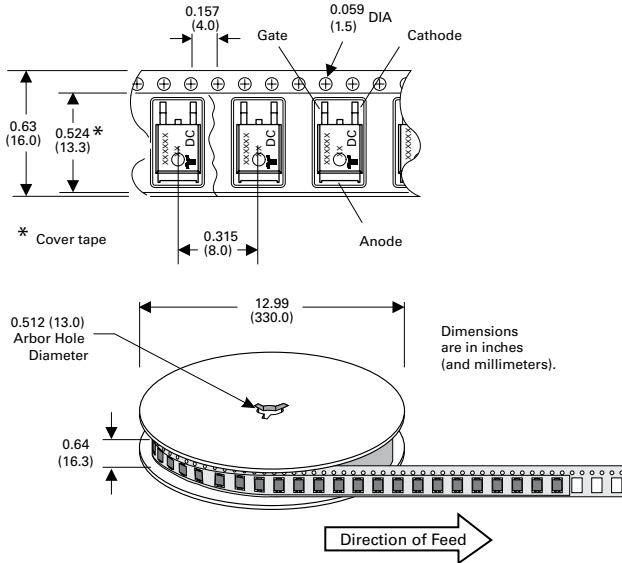

Part Marking System

TO-251AA- (V Package)
TO-252AA- (D Package)

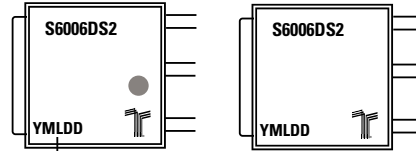

Date Code Marking
Y: Year Code
M: Month Code
L: Location Code
DD: Calendar Code

TO-263 AA - (N Package)
TO-220 AB - (L and R Package)



Date Code Marking
Y: Year Code
M: Month Code
XXX: Lot Trace Code

Part Numbering System



Looking for pricing, stock, or lifecycle information?

Click below to explore more details on WIN SOURCE:

 [View S4006VS2TP on WIN SOURCE](#)

 [Littelfuse Inc. Information](#)

Optimize Your Supply Chain with WIN SOURCE Solutions

-  Global Sourcing Solution
-  Obsolete Management
-  Cost Control Management
-  Shortage Management
-  Alternative Solution
-  Excess Inventory Management