



**THE DATASHEET OF  
ST2100C38R0**



## PHASE CONTROL THYRISTORS

## Hockey Puk Version

### Features

- Double side cooling
- High surge capability
- High mean current
- Fatigue free

### Typical Applications

- DC motor controls
- Controlled DC power supplies
- AC controllers

### Major Ratings and Characteristics

Parameters	ST2100C..R	Units
$I_{T(AV)}$	1770	A
	@ $T_C$	80 °C
$I_{T(AV)}$	2090	A
	@ $T_{hs}$	55 °C
$I_{T(RMS)}$	3850	A
	@ $T_{hs}$	25 °C
$I_{TSM}$	@ 50Hz	36250 A
	@ 60Hz	38000 A
$I^2t$	@ 50Hz	6570 KA <sup>2</sup> s
	@ 60Hz	5990 KA <sup>2</sup> s
$V_{DRM}/V_{RRM}$	3000 to 4200	V
$t_q$	typical	500 $\mu$ s
$T_J$	max.	125 °C

2090A

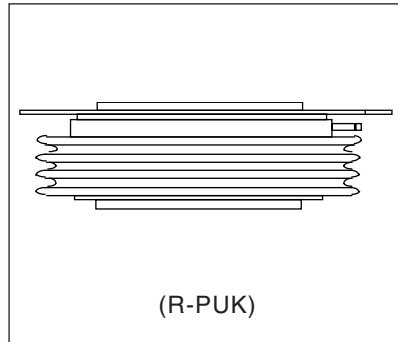

## ST2100C..R Series

Bulletin I25198 rev. B 02/00

International  
 Rectifier

### ELECTRICAL SPECIFICATIONS

#### Voltage Ratings

Type number	Voltage Code	$V_{DRM}/V_{RRM}$ , max. repetitive peak and off-state voltage V	$V_{RSM}$ , maximum non-repetitive peak voltage V	$I_{DRM}/I_{RRM}$ max. @ $T_C = 125^\circ\text{C}$ mA
ST2100C..R	30	3000	3100	250
	32	3200	3300	
	34	3400	3500	
	36	3600	3700	
	38	3800	3900	
	40	4000	4100	
	42	4200	4300	

#### On-state Conduction

Parameter	ST2100C..R	Units	Conditions
$I_{T(AV)}$ Max. average on-state current @ Case temperature	1770 (1150)	A	180° conduction, half sine wave double side (single side [anode side]) cooled
	80	°C	
$I_{T(AV)}$ Max. average on-state current @ Heatsink temperature	2090 (940)	A	
	55 (85)	°C	
$I_{T(RMS)}$ Max. RMS on-state current	3850	A	DC @ 25°C heatsink temperature double side cooled
$I_{TSM}$ Max. peak, one-cycle non-repetitive surge current	36250	A	t = 10ms No voltage
	38000		t = 8.3ms reapplied
	29000		t = 10ms 50% $V_{RRM}$
	30350		t = 8.3ms reapplied
$I^2t$ Maximum $I^2t$ for fusing	6570	KA <sup>2</sup> S	t = 10ms No voltage
	5990		t = 8.3ms reapplied
	4205		t = 10ms 50% $V_{RRM}$
	3820		t = 8.3ms reapplied
$V_{T(TO)}$ Max. value of threshold voltage	1.03	V	$T_J = T_J$ max.
$r_t$ Max. value of on-state slope resistance	0.32	mΩ	$T_J = T_J$ max.
$V_{TM}$ Max. on-state voltage	1.875	V	$I_{pk} = 2900\text{A}$ , $T_C = 25^\circ\text{C}$
$I_L$ Typical latching current	300	mA	$T_J = 25^\circ\text{C}$ , $V_D = 5\text{V}$

#### Switching

Parameter	ST2100C..R	Units	Conditions
$di/dt$ Max. repetitive 50Hz (no repetitive) rate of rise of turned-on current	150 (300)	A/μs	From 67% $V_{DRM}$ to 1000A gate drive 20V, 10Ω, $t_r = 0.5\mu\text{s}$ $T_J = T_J$ max.
$t_d$ Maximum delay time	2.5	μs	Gate drive 30V, 15Ω, $V_d = 67\% V_{DRM}$ , $T_J = 25^\circ\text{C}$ Rise time 0.5μs
$t_q$ Typical turn-off time	500		$I_T = 1000\text{A}$ , $t_p = 1\text{ms}$ , $T_J = T_J$ max, $V_{RM} = 50\text{V}$ , $dI_{RR}/dt = 2\text{A}/\mu\text{s}$ , $V_{DR} = 67\% V_{DRM}$ , $dV_{DR}/dt = 8\text{V}/\mu\text{s}$ linear

**Blocking**

Parameter	ST2100C..R	Units	Conditions
dv/dt Maximum linear rate of rise of off-state voltage	500	V/ $\mu$ s	$T_J = T_J$ max. to 67% rated $V_{DRM}$
$I_{RRM}$ $I_{DRM}$ Max. peak reverse and off-state leakage current	250	mA	$T_J = 125^\circ\text{C}$ rated $V_{DRM}/V_{RRM}$ applied

**Triggering**

Parameter	ST2100C..R	Units	Conditions
$P_{GM}$ Maximum peak gate power	150	W	$t_p = 100\mu\text{s}$
$P_{G(AV)}$ Maximum average gate power	10		
$I_{GM}$ Max. peak positive gate current	30	A	Anode positive with respect to cathode
$V_{GM}$ Max. peak positive gate voltage	30	V	Anode positive with respect to cathode
$-V_{GM}$ Max. peak negative gate voltage	0.25	V	Anode positive with respect to cathode
$I_{GT}$ Maximum DC gate current required to trigger	400	mA	$T_C = 25^\circ\text{C}$ , $V_{DRM} = 5\text{V}$
$V_{GT}$ Maximum gate voltage required to trigger	4	V	$T_C = 25^\circ\text{C}$ , $V_{DRM} = 5\text{V}$
$V_{GD}$ DC gate voltage not to trigger	0.25	V	$T_C = 125^\circ\text{C}$ Max. gate current/voltage not to trigger is the max. value which will not trigger any unit with rated $V_{DRM}$ anode-to-cathode applied

**Thermal and Mechanical Specification**

Parameter	ST2100C..R	Units	Conditions	
$T_J$ max. Max. operating temperature	125	$^\circ\text{C}$	On-state (conducting)	
$T_{stg}$ Max. storage temperature range	-55 to 125			
$R_{thJ-C}$ Thermal resistance, junction to case	0.019 0.0095	K/W	DC operation single side cooled DC operation double side cooled	
$R_{th(C-h)}$ Thermal resistance, case to heatsink	0.004 0.002	K/W	Single side cooled Double side cooled	Clamping force 43KN with mounting compound
F Mounting force $\pm 10\%$	43000 (4400)	N (Kg)		
wt Approximate weight	1600	g		
Case style	(R-PUK)		See Outline Table	

**$\Delta R_{thJ-C}$  Conduction**

(The following table shows the increment of thermal resistance  $R_{thJ-C}$  when devices operate at different conduction angles than DC)

Conduction angle	Single side	Double side	Units	Conditions
180 $^\circ$	0.0010	0.0010	K/W	$T_J = T_J$ max.
120 $^\circ$	0.0017	0.0017		
60 $^\circ$	0.0044	0.0044		

# ST2100C..R Series

Bulletin I25198 rev. B 02/00

## Ordering Information Table

Device Code							
ST	210	0	C	42	R	1	
①	②	③	④	⑤	⑥	⑦	⑧
<b>1</b>	- Thyristor	<b>2</b>	- Essential part number	<b>3</b>	- 0 = Converter grade	<b>4</b>	- C = Ceramic Puk
<b>5</b>	- Voltage code: Code x 100 = $V_{RRM}$ (See Voltage Rating Table)	<b>6</b>	- R = Puk Case	<b>7</b>	- 0 = Eyelet terminals (Gate and Auxiliary Cathode Unsoldered Leads) 1 = Fast-on terminals (Gate and Auxiliary Cathode Unsoldered Leads) 2 = Eyelet terminals (Gate and Auxiliary Cathode Soldered Leads) 3 = Fast-on terminals (Gate and Auxiliary Cathode Soldered Leads)	<b>8</b>	- Critical dv/dt: None = 500V/ $\mu$ sec (Standard selection) L = 1000V/ $\mu$ sec (Special selection)

## Outline Table

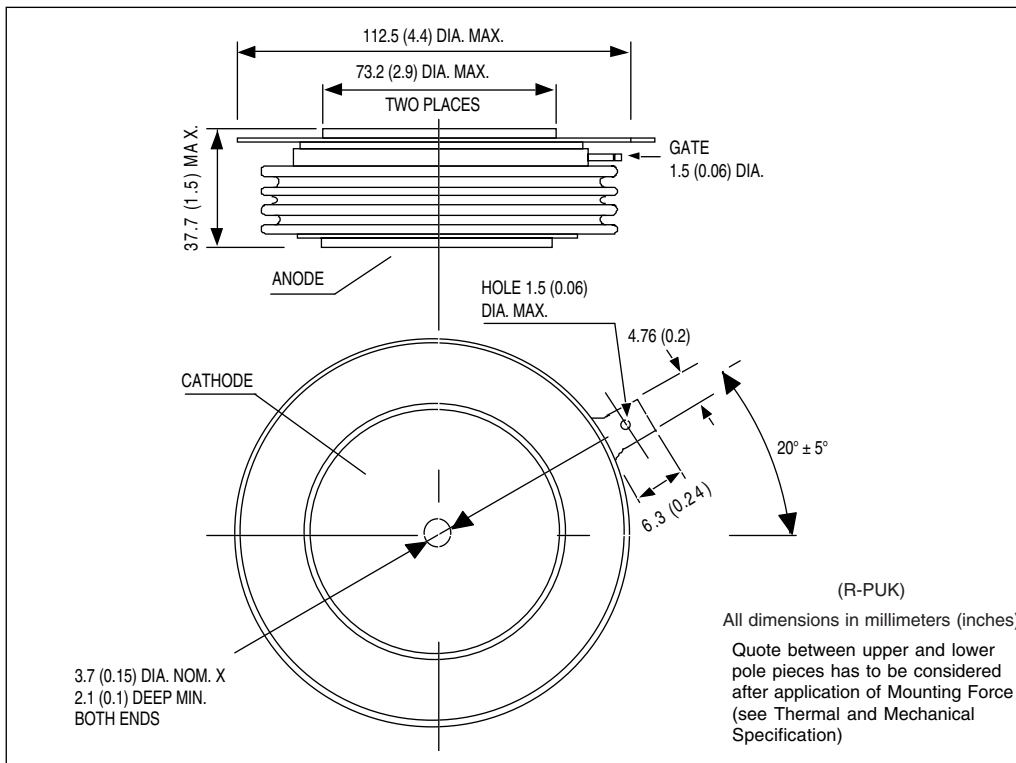

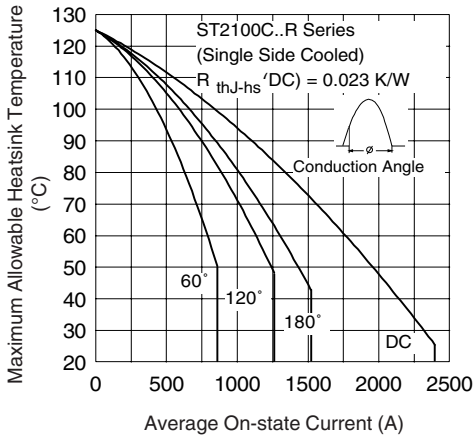

Fig. 1 - Current Ratings Characteristics

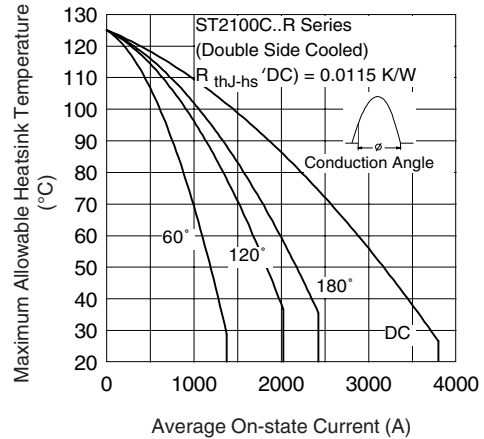

Fig. 2 - Current Ratings Characteristics

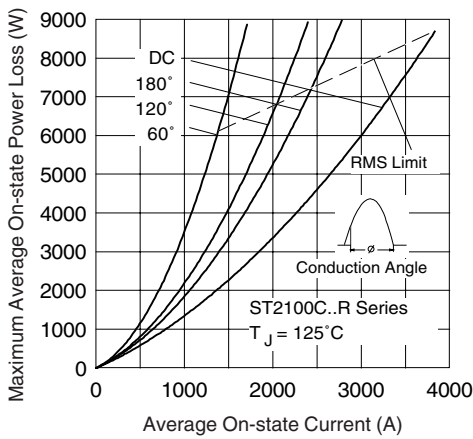

Fig. 3 - On-state Power Loss Characteristics

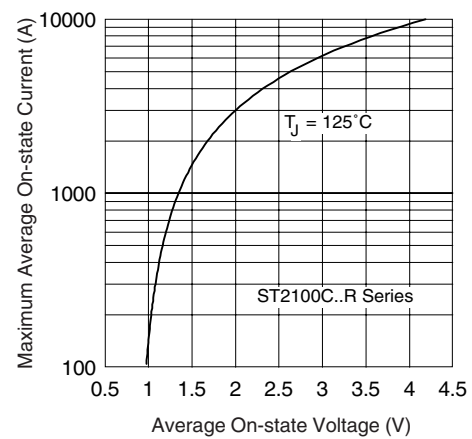

Fig. 4 - On-state Voltage Drop Characteristics

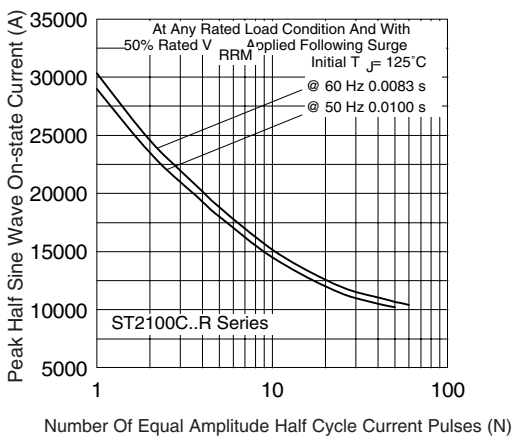

Fig. 5 - Maximum Non-Repetitive Surge Current Single and Double Side Cooled

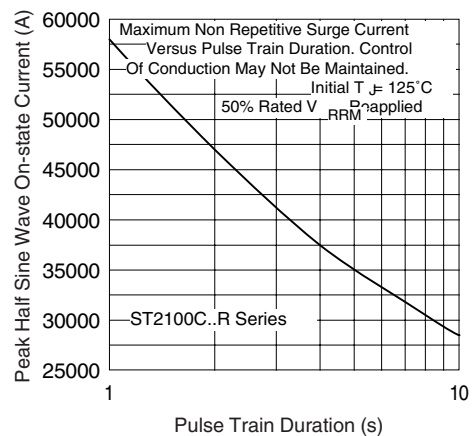

Fig. 6 - Maximum Non-Repetitive Surge Current Single and Double Side Cooled

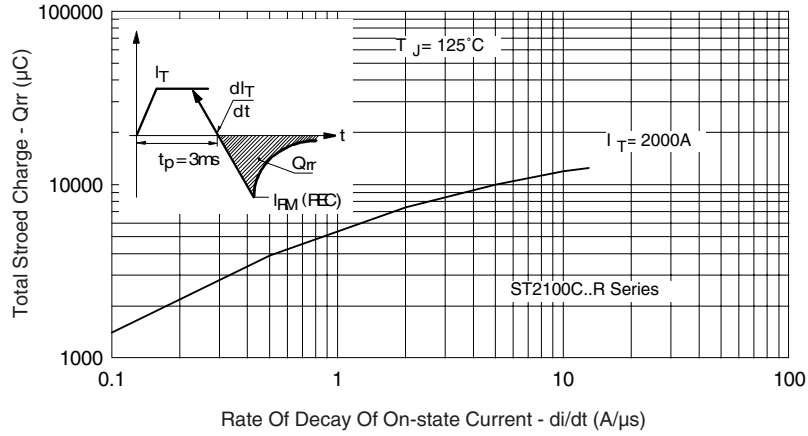

Fig. 7 - Stored Charge

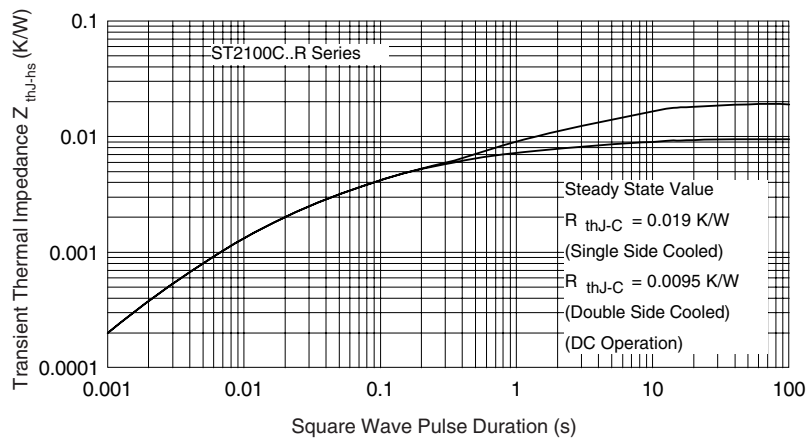

Fig. 10 - Thermal Impedance  $Z_{thJ-hs}$  Characteristics

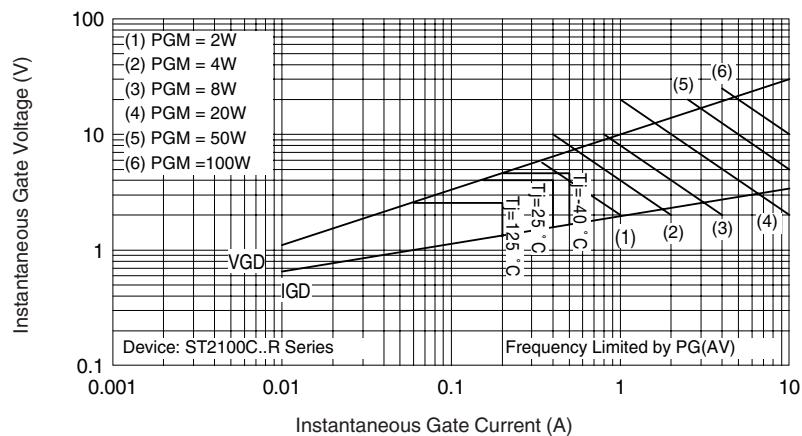

Fig. 11 - Gate Characteristics

## Looking for pricing, stock, or lifecycle information?

Click below to explore more details on WIN SOURCE:

 [View ST2100C38R0 on WIN SOURCE](#)

 [Vishay Information](#)

## Optimize Your Supply Chain with WIN SOURCE Solutions

-  Global Sourcing Solution
-  Obsolete Management
-  Cost Control Management
-  Shortage Management
-  Alternative Solution
-  Excess Inventory Management