



THE DATASHEET OF STGP3NB60HD





STGP3NB60HD - STGP3NB60HDFP STGB3NB60HD

N-CHANNEL 3A - 600V - TO-220/TO-220FP/D²PAK

PowerMESH™ IGBT

TYPE	V _{CES}	V _{CE(sat)} (Max) @25°C	I _c (#) @100°C
STGB3NB60HD	600 V	< 2.8 V	6 A
STGP3NB60HD	600 V	< 2.8 V	6 A
STGP3NB60HDFP	600 V	< 2.8 V	6 A

- HIGH INPUT IMPEDANCE (VOLTAGE DRIVEN)
- LOW GATE CHARGE
- HIGH FREQUENCY OPERATION
- HIGH CURRENT CAPABILITY
- OFF LOSSES INCLUDE TAIL CURRENT
- CO-PACKAGED WITH TURBOSWITCH™ ANTIPARALLEL DIODE

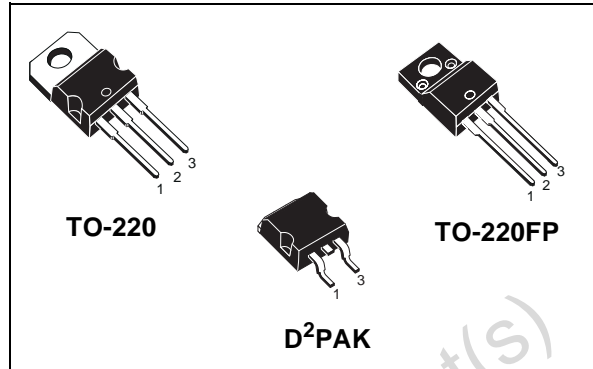

DESCRIPTION

Using the latest high voltage technology based on a patented strip layout, STMicroelectronics has designed an advanced family of IGBTs, the PowerMESH™ IGBTs, with outstanding performances.

The suffix "H" identifies a family optimized for high frequency applications (up to 50kHz) in order to achieve very high switching performances (reduced fall) maintaining a low voltage drop.

APPLICATIONS

- HIGH FREQUENCY MOTOR CONTROLS
- SMPS and PFC IN BOTH HARD SWITCH AND RESONANT TOPOLOGIES

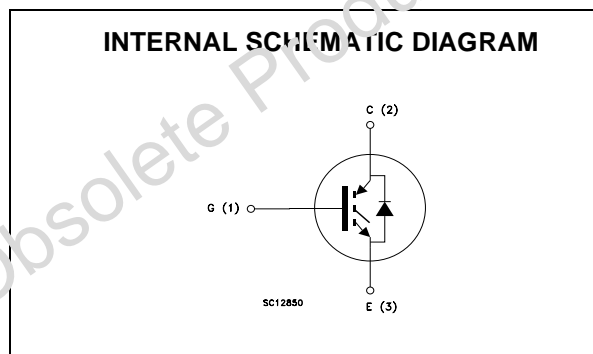

ORDERING INFORMATION

SALES TYPE	MARKING	PACKAGE	PACKAGING
STGB3NB60HDT4	GB3NB60HD	D ² PAK	TAPE & REEL
STGP3NB60HD	GP3NB60HD	TO-220	TUBE
STGP3NB60HDFP	GP3NB60HDFP	TO-220FP	TUBE

STGP3NB60HD - STGP3NB60HDFP - STGB3NB60HD

ABSOLUTE MAXIMUM RATINGS

Symbol	Parameter	Value		Unit
		STGP3NB60HD STGB3NB60HD	STGP3NB60HDFP	
V _{CES}	Collector-Emitter Voltage (V _{GS} = 0)	600		V
V _{GE}	Gate-Emitter Voltage	± 20		V
I _C	Collector Current (continuous) at T _C = 25°C (#)	10		A
I _C	Collector Current (continuous) at T _C = 100°C (#)	6		A
I _{CM} (■)	Collector Current (pulsed)	24		A
P _{TOT}	Total Dissipation at T _C = 25°C	50	25	W
	Derating Factor	0.4	0.2	W/°C
T _{stg}	Storage Temperature	-55 to 150		°C
T _j	Operating Junction Temperature			

(■) Pulse width limited by safe operating area

THERMAL DATA

		TO-220/D ² PAK	TO-220FP	
R _{thj-case}	Thermal Resistance Junction-case Max	2.5	5	°C/W
R _{thj-amb}	Thermal Resistance Junction-ambient Max	62.5		°C/W

ELECTRICAL CHARACTERISTICS (T_{CASE} = 25 °C UNLESS OTHERWISE SPECIFIED)

OFF

Symbol	Parameter	Test Conditions	Min.	Typ.	Max.	Unit
V _{BR(CES)}	Collector-Emitter Breakdown Voltage	I _C = 250 μA, V _{GE} = 0	600			V
I _{CES}	Collector cut-off (V _{GE} = 0)	V _{CE} = Max Rating, T _C = 25 °C V _{CE} = Max Rating, T _C = 125 °C			50 100	μA μA
I _{GES}	Gate-Emitter Leakage Current (V _{CE} = 0)	V _{GE} = ±20V, V _{CE} = 0			±100	nA

ON (1)

Symbol	Parameter	Test Conditions	Min.	Typ.	Max.	Unit
V _{GE(th)}	Gate Threshold Voltage	V _{CE} = V _{GE} , I _C = 250μA	3		5	V
V _{CE(sat)}	Collector-Emitter Saturation Voltage	V _{GE} = 15V, I _C = 3 A V _{GE} = 15V, I _C = 3 A, T _j = 125°C		2.4 1.9	2.8	V V

(#) Calculated according to the iterative formula:

$$I_C(T_C) = \frac{T_{JMAX} - T_C}{R_{THJ-C} \times V_{CESAT(MAX)}(T_C, I_C)}$$

ELECTRICAL CHARACTERISTICS (CONTINUED)

DYNAMIC

Symbol	Parameter	Test Conditions	Min.	Typ.	Max.	Unit
g_{fs}	Forward Transconductance	$V_{CE} = 25\text{ V}, I_C = 3\text{ A}$		2.4		S
C_{ies} C_{oes} C_{res}	Input Capacitance Output Capacitance Reverse Transfer Capacitance	$V_{CE} = 25\text{ V}, f = 1\text{ MHz}, V_{GE} = 0$		235 33 6.6		pF pF pF
Q_g Q_{ge} Q_{gc}	Total Gate Charge Gate-Emitter Charge Gate-Collector Charge	$V_{CE} = 480\text{ V}, I_C = 3\text{ A},$ $V_{GE} = 15\text{ V}$		21 6 7.6	27	nC nC nC
I_{CL}	Latching Current	$V_{clamp} = 480\text{ V}, T_j = 125^\circ\text{C}$ $R_G = 10\ \Omega$	12			A

SWITCHING ON

Symbol	Parameter	Test Conditions	Min.	Typ.	Max.	Unit
$t_{d(on)}$ t_r	Turn-on Delay Time Rise Time	$V_{CC} = 480\text{ V}, I_C = 3\text{ A}$ $R_G = 10\ \Omega, V_{GE} = 15\text{ V}$		5 11		ns ns
$(di/dt)_{on}$ Eon	Turn-on Current Slope Turn-on Switching Losses	$V_{CC} = 480\text{ V}, I_C = 3\text{ A}, R_G = 10\ \Omega$ $V_{GE} = 15\text{ V}, T_j = 125^\circ\text{C}$		400 77		A/ μs μJ

SWITCHING OFF

Symbol	Parameter	Test Conditions	Min.	Typ.	Max.	Unit
t_c $t_r(V_{off})$ $t_{d(off)}$ t_f $E_{off(**)}$ E_{ts}	Cross-over Time Off Voltage Rise Time Delay Time Fall Time Turn-off Switching Loss Total Switching Loss	$V_{CC} = 480\text{ V}, I_C = 3\text{ A},$ $R_{GE} = 10\ \Omega, V_{GE} = 15\text{ V}$		76 36 53 77 33 110		ns ns ns ns μJ μJ
t_c $t_r(V_{off})$ $t_{d(off)}$ t_f $E_{off(**)}$ E_{ts}	Cross-over Time Off Voltage Rise Time Delay Time Fall Time Turn-off Switching Loss Total Switching Loss	$V_{CC} = 480\text{ V}, I_C = 3\text{ A},$ $R_{GE} = 10\ \Omega, V_{GE} = 15\text{ V}$ $T_j = 125^\circ\text{C}$		180 82 58 110 88 165		ns ns ns ns μJ μJ

Note: 1. Pulsed: Pulse duration = 300 μs , duty cycle 1.5 %.
2. Pulse width limited by max. junction temperature.
(**)Losses include Also the Tail (Jedec Standardization)

COLLECTOR-EMITTER DIODE

Symbol	Parameter	Test Conditions	Min.	Typ.	Max.	Unit
I_f I_{fm}	Forward Current Forward Current pulsed				3 24	A A
V_f	Forward On-Voltage	$I_f = 3\text{ A}$ $I_f = 3\text{ A}, T_j = 125^\circ\text{C}$		1.6 1.4	2.0	V V
t_{rr} Q_{rr} I_{rrm}	Reverse Recovery Time Reverse Recovery Charge Reverse Recovery Current	$I_f = 3\text{ A}, V_R = 35\text{ V},$ $T_j = 125^\circ\text{C}, di/dt = 100\text{ A}/\mu\text{s}$		45 70 2.7		ns nC A

Thermal Impedance for TO-220/D²PAK

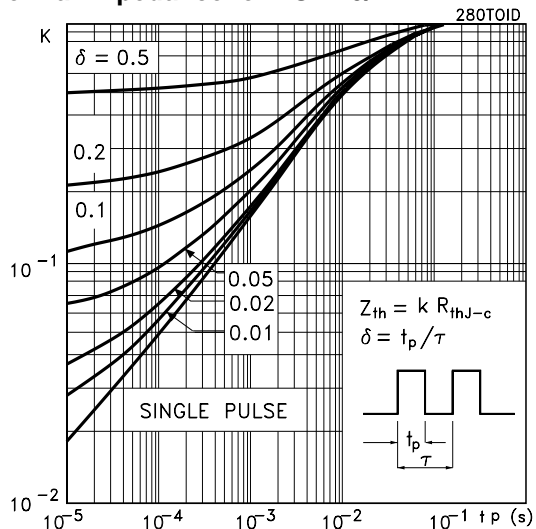

Thermal Impedance for TO-220FP

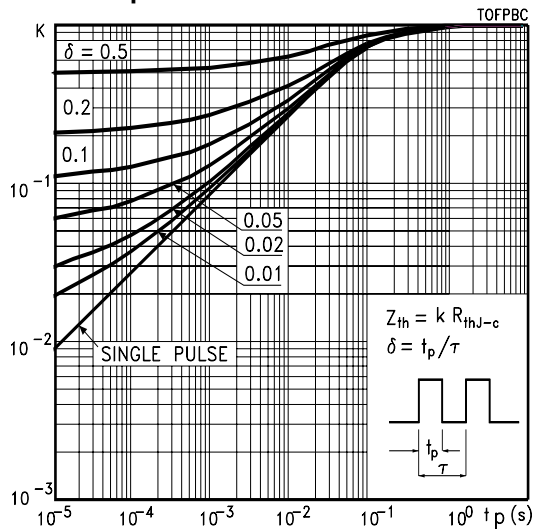

Output Characteristics

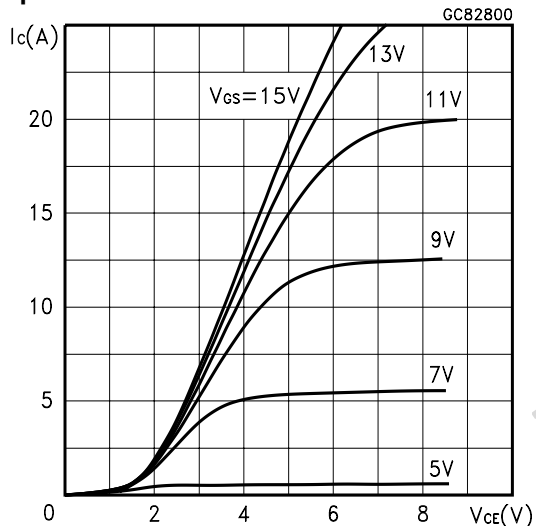

Transfer Characteristics

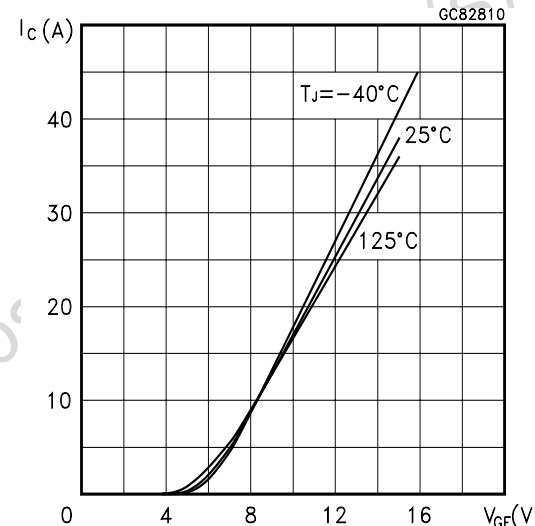

Transconductance

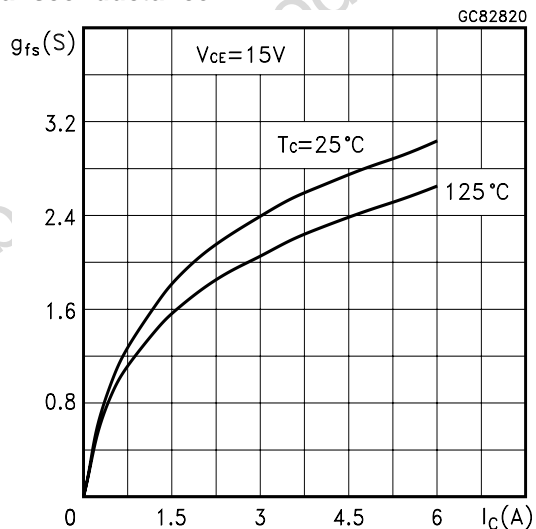

Collector-Emitter On Voltage vs Temperature

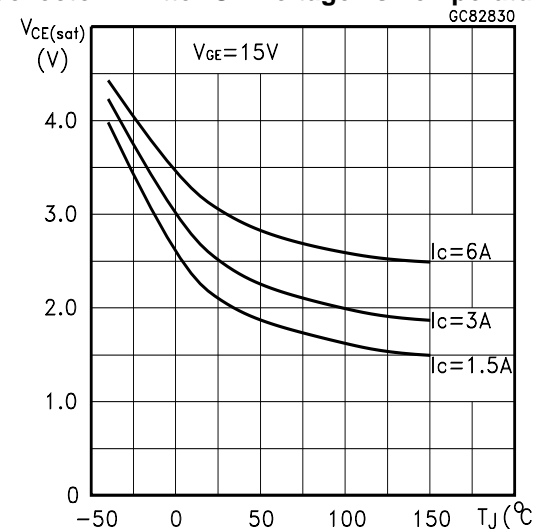

Collector-Emitter On Voltage vs Collector Current

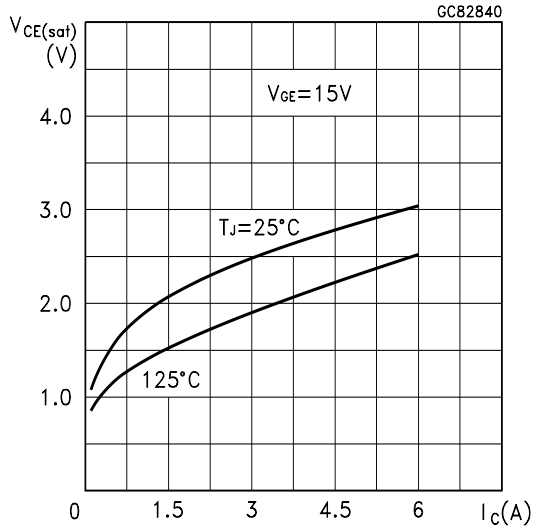

Gate Threshold vs Temperature

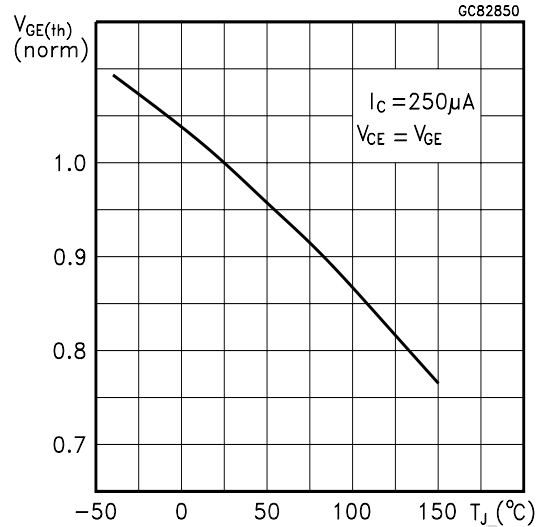

Normalized Breakdown Voltage vs Temperature

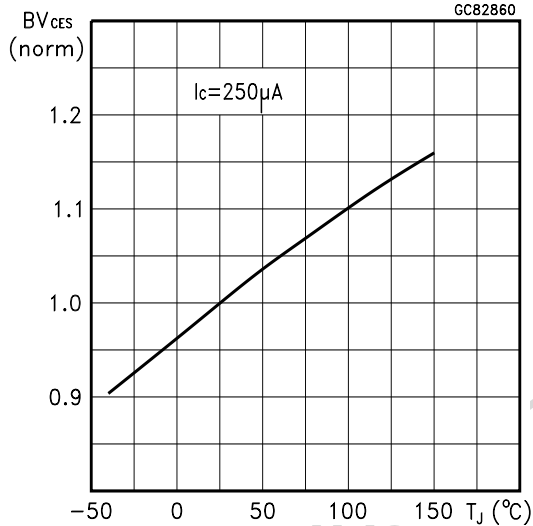

Capacitance Variations

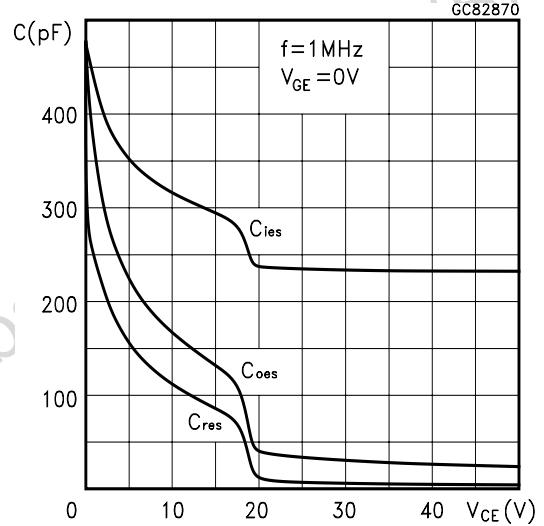

Gate Charge vs Gate-Emitter Voltage

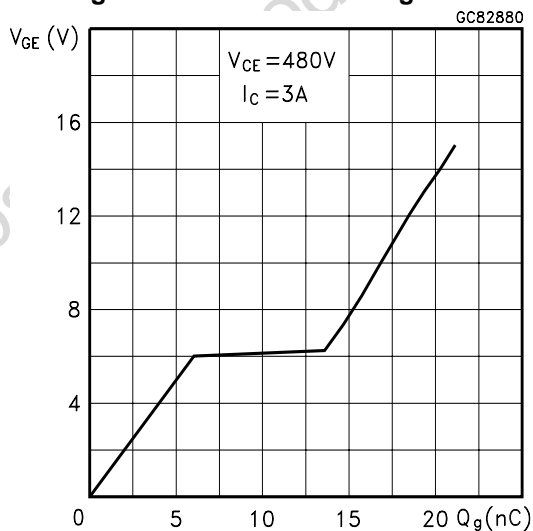

Total Switching Losses vs Gate Resistance

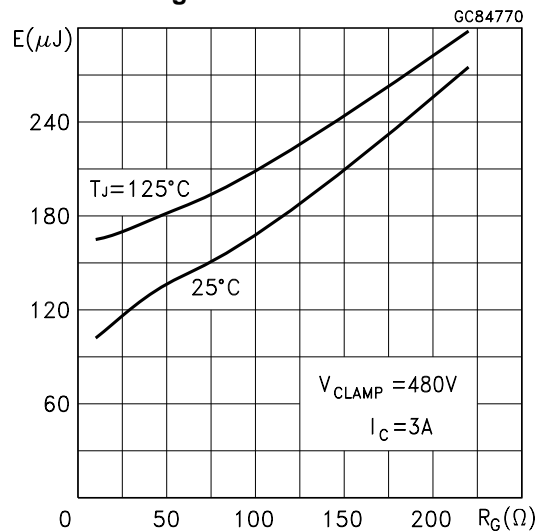

STGP3NB60HD - STGP3NB60HDFP - STGB3NB60HD

Total Switching Losses vs Temperature

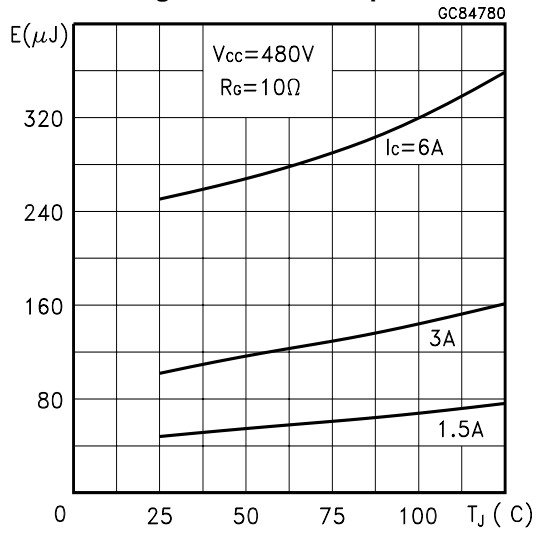

Emitter-collector Diode Characteristics

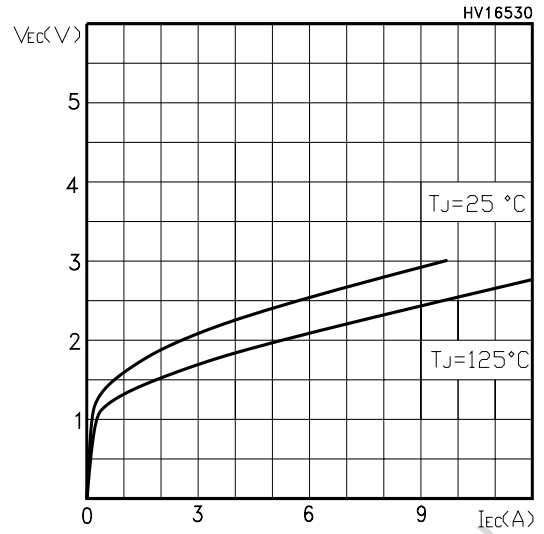

Total Switching Losses vs Collector Current

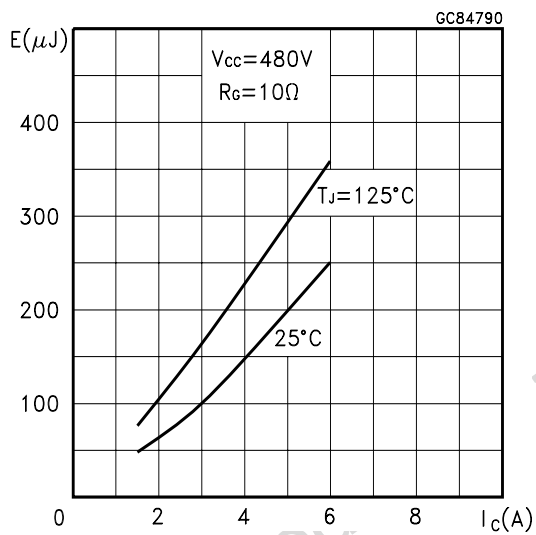

Switching Off Safe Operating Area

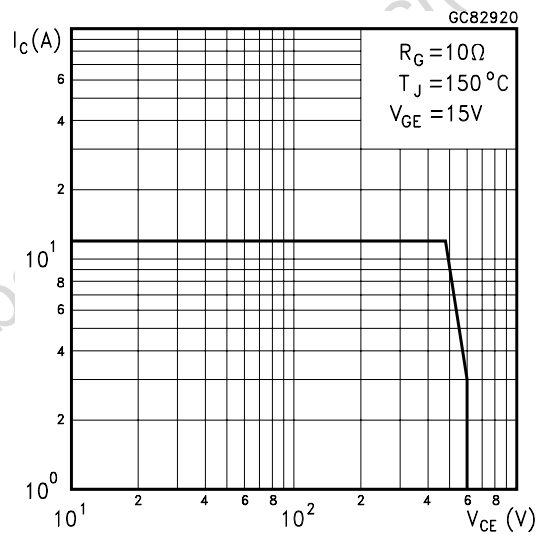

Obsolete Proc

TO-220 MECHANICAL DATA

DIM.	mm.			inch		
	MIN.	TYP.	MAX.	MIN.	TYP.	MAX.
A	4.40		4.60	0.173		0.181
b	0.61		0.88	0.024		0.034
b1	1.15		1.70	0.045		0.066
c	0.49		0.70	0.019		0.027
D	15.25		15.75	0.60		0.620
E	10		10.40	0.393		0.409
e	2.40		2.70	0.094		0.106
e1	4.95		5.15	0.194		0.202
F	1.23		1.32	0.048		0.052
H1	6.20		6.60	0.244		0.256
J1	2.40		2.72	0.094		0.107
L	13		14	0.511		0.551
L1	3.50		3.93	0.137		0.154
L20		16.40			0.645	
L30		28.90			1.137	
øP	3.75		3.85	0.147		0.151
Q	2.65		2.95	0.104		0.116

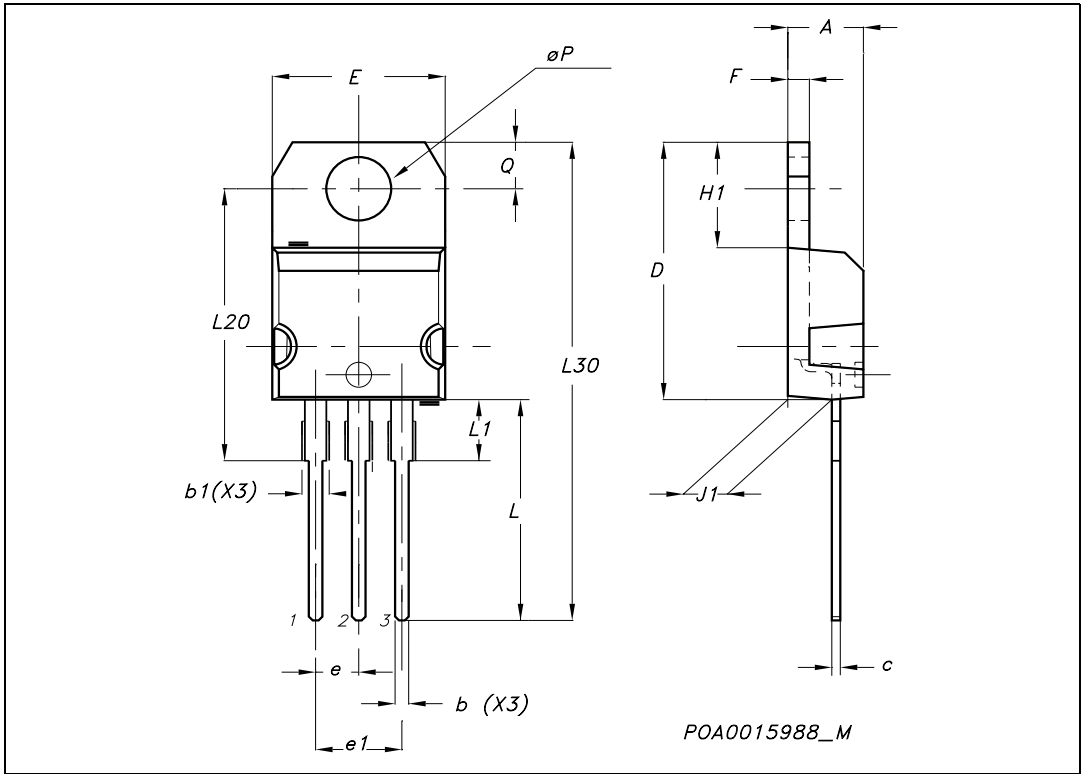

TO-220FP MECHANICAL DATA

DIM.	mm.			inch		
	MIN.	TYP	MAX.	MIN.	TYP.	MAX.
A	4.4		4.6	0.173		0.181
B	2.5		2.7	0.098		0.106
D	2.5		2.75	0.098		0.108
E	0.45		0.7	0.017		0.027
F	0.75		1	0.030		0.039
F1	1.15		1.7	0.045		0.067
F2	1.15		1.7	0.045		0.067
G	4.95		5.2	0.195		0.204
G1	2.4		2.7	0.094		0.106
H	10		10.4	0.393		0.409
L2		16			0.630	
L3	28.6		30.6	1.126		1.204
L4	9.8		10.6	.0385		0.417
L5	2.9		3.6	0.114		0.141
L6	15.9		16.4	0.626		0.645
L7	9		9.3	0.354		0.366
Ø	3		3.2	0.118		0.126

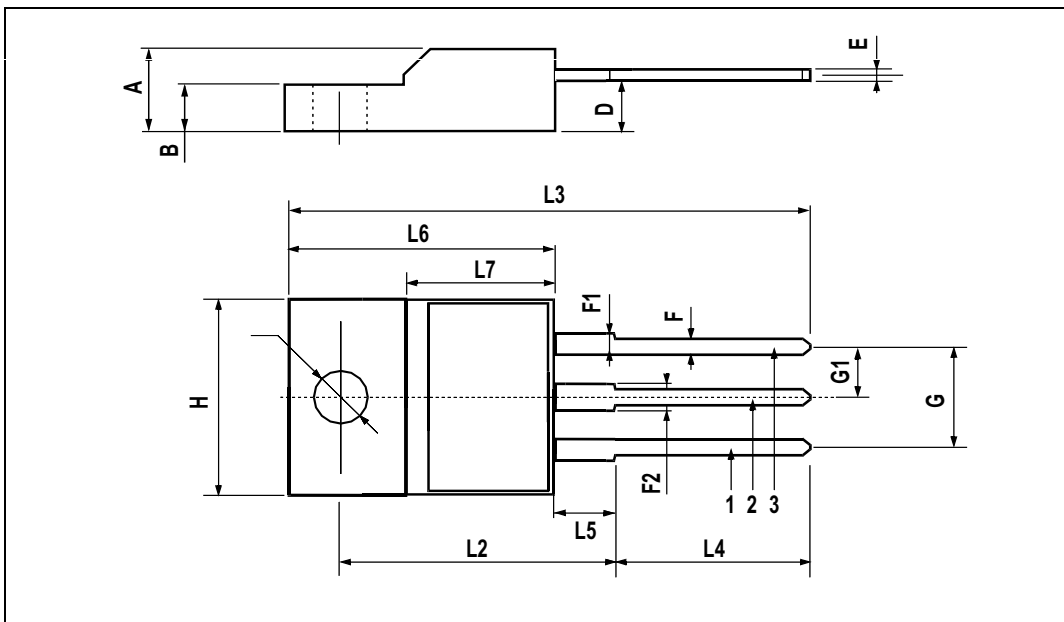

D²PAK MECHANICAL DATA

DIM.	mm.			inch		
	MIN.	TYP	MAX.	MIN.	TYP.	MAX.
A	4.4		4.6	0.173		0.181
A1	2.49		2.69	0.098		0.106
A2	0.03		0.23	0.001		0.009
B	0.7		0.93	0.027		0.036
B2	1.14		1.7	0.044		0.067
C	0.45		0.6	0.017		0.023
C2	1.23		1.36	0.048		0.053
D	8.95		9.35	0.352		0.368
D1		8			0.315	
E	10		10.4	0.393		
E1		8.5			0.334	
G	4.88		5.28	0.192		0.208
L	15		15.85	0.590		0.625
L2	1.27		1.4	0.050		0.055
L3	1.4		1.75	0.055		0.068
M	2.4		3.2	0.094		0.126
R		0.4			0.015	
V2	0°		4°			

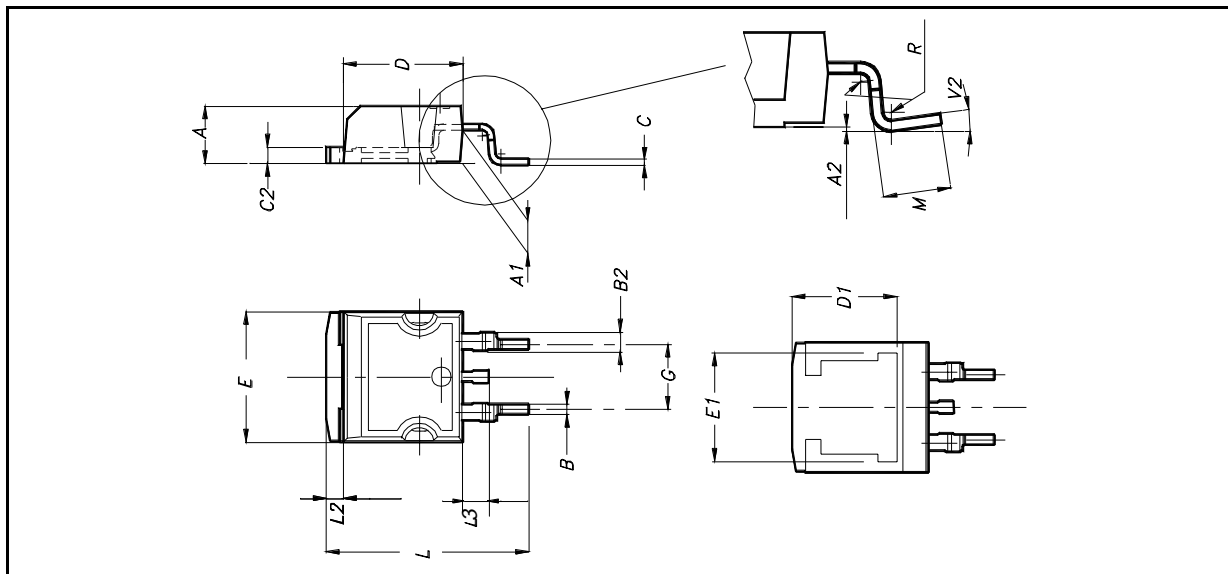

Information furnished is believed to be accurate and reliable. However, STMicroelectronics assumes no responsibility for the consequences of use of such information nor for any infringement of patents or other rights of third parties which may result from its use. No license is granted by implication or otherwise under any patent or patent rights of STMicroelectronics. Specifications mentioned in this publication are subject to change without notice. This publication supersedes and replaces all information previously supplied. STMicroelectronics products are not authorized for use as critical components in life support devices or systems without express written approval of STMicroelectronics.

© The ST logo is a registered trademark of STMicroelectronics



© 2003 STMicroelectronics - Printed in Italy - All Rights Reserved
STMicroelectronics GROUP OF COMPANIES

Australia - Brazil - Canada - China - Finland - France - Germany - Hong Kong - India - Israel - Italy - Japan - Malaysia - Malta - Morocco
Singapore - Spain - Sweden - Switzerland - United Kingdom - United States.

© <http://www.st.com>

Looking for pricing, stock, or lifecycle information?

Click below to explore more details on WIN SOURCE:

-  [View STGP3NB60HD](#) on WIN SOURCE
-  [STMicroelectronics](#) Information

Optimize Your Supply Chain with WIN SOURCE Solutions

-  Global Sourcing Solution
-  Obsolete Management
-  Cost Control Management
-  Shortage Management
-  Alternative Solution
-  Excess Inventory Management