



**THE DATASHEET OF
SRF2012A-900YA**





Features

- Shielded construction – low radiation
- Bifilar wound
- Impedance range: 67 to 360 ohms @ 100 MHz
- AEC-Q200 qualified
- RoHS compliant* and halogen free**

Applications

- EMI suppression for:
 - Data and signal lines
 - CANbus
 - Automotive electronics
 - Consumer electronics
 - Telecom devices

SRF2012AA Series - Common Mode Chip Inductors

Electrical Specifications @ 25 °C

Bourns Part Number	Impedance @ 100 MHz / 1 V		DCR Typ. (Ω)	DCR Max. (Ω)	I _{rms} (mA)
	Z (Ω)	Tolerance (%)			
SRF2012A-670YA	67	± 25	0.15	0.25	400
SRF2012A-900YA	90	± 25	0.16	0.30	400
SRF2012A-121YA	120	± 25	0.20	0.30	400
SRF2012A-161YA	160	± 25	0.25	0.35	350
SRF2012A-181YA	180	± 25	0.25	0.35	350
SRF2012A-201YA	200	± 25	0.30	0.40	300
SRF2012A-221YA	220	± 25	0.30	0.40	300
SRF2012A-261YA	260	± 25	0.35	0.40	300
SRF2012A-361YA	360	± 25	0.45	0.50	300

Soldering Profile

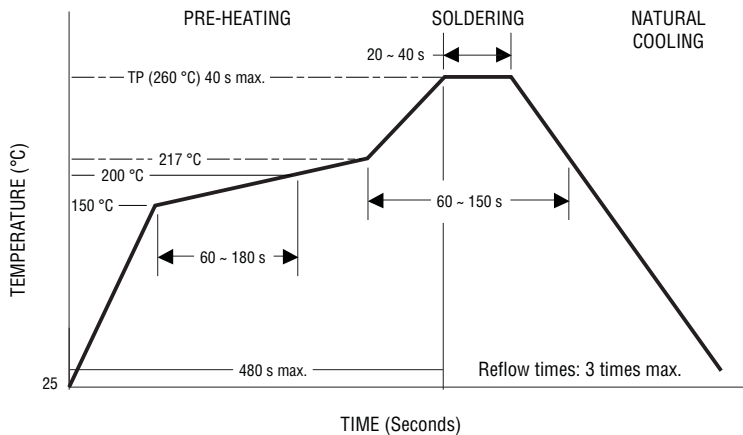

General Specifications

Rated Voltage 50 VDC
 Withstanding Voltage 125 VDC
 Insulation Resistance 10 megohms min. @ 100 VDC
 Operating Temperature -40 °C to +125 °C
 (Temperature rise included)
 Storage Temperature -40 °C to +125 °C
 Temperature Rise 20 °C at rated I_{rms}

Materials

Core Ferrite
 Wire Enameled copper
 Terminal Finish Sn
 Packaging 2000 pcs. per 7-inch reel

Product Dimensions

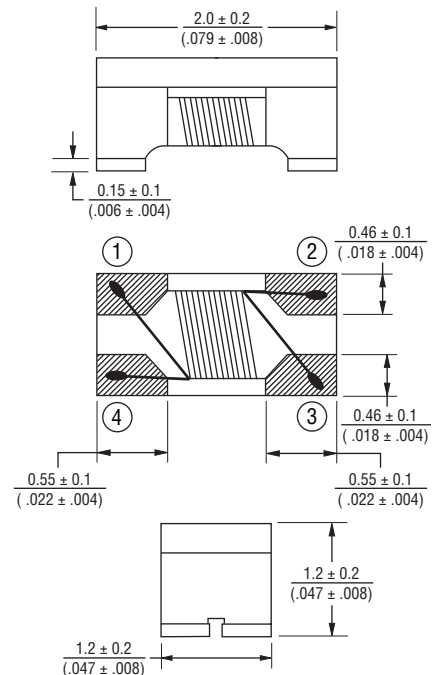

How to Order

SRF2012A - 201 Y A

Model _____
 Value Code (see table) _____
 Tolerance Code _____
 Model Suffix _____

Schematic

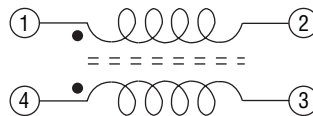

BOURNS®

Asia-Pacific: Tel: +886-2 2562-4117 • Fax: +886-2 2562-4116

EMEA: Tel: +36 88 520 390 • Fax: +36 88 520 211

The Americas: Tel: +1-951 781-5500 • Fax: +1-951 781-5700

www.bourns.com

* RoHS Directive 2002/95/EC Jan. 27, 2003 including annex and RoHS Recast 2011/65/EU June 8, 2011.

**Bourns considers a product to be "halogen free" if (a) the Bromine (Br) content is 900 ppm or less; (b) the Chlorine (Cl) content is 900 ppm or less; and (c) the total Bromine (Br) and Chlorine (Cl) content is 1500 ppm or less.

Specifications are subject to change without notice.

The device characteristics and parameters in this data sheet can and do vary in different applications and actual device performance may vary over time.

Users should verify actual device performance in their specific applications.

Recommended Layout

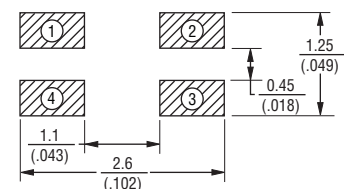

DIMENSIONS: $\frac{\text{MM}}{\text{(INCHES)}}$

SRF2012AA Series - Common Mode Chip Inductors

BOURNS®

Typical Impedance vs. Frequency Curves

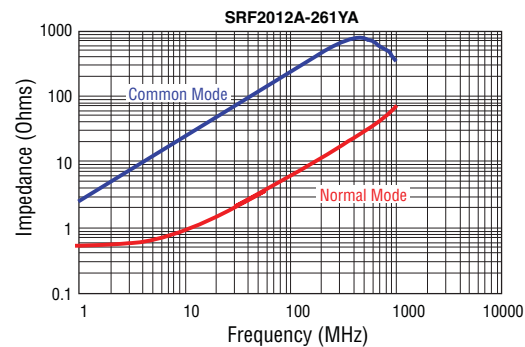
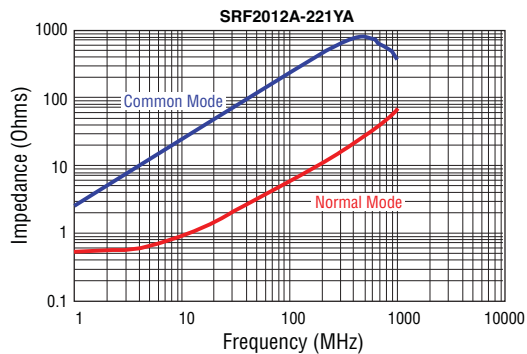
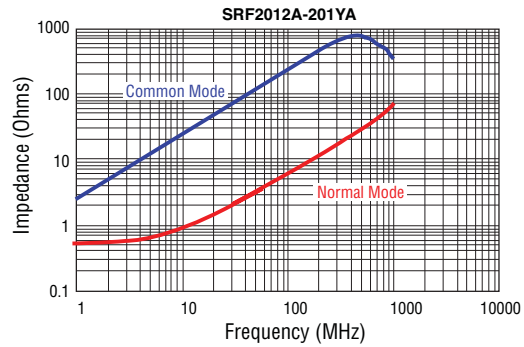
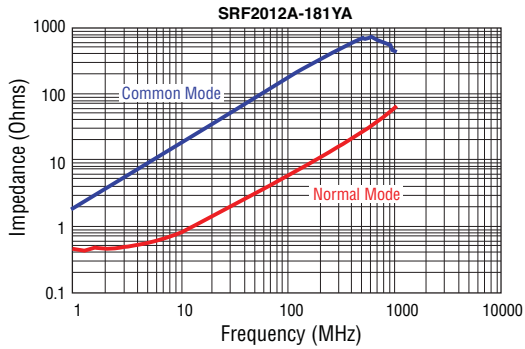
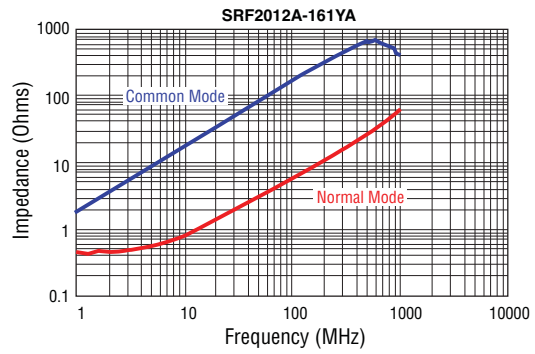
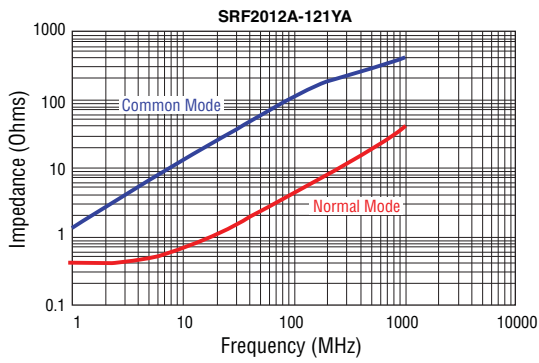
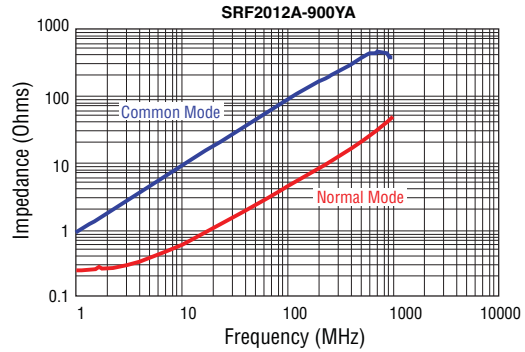
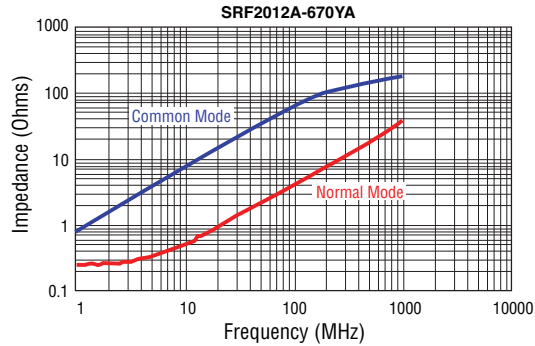

Specifications are subject to change without notice.
The device characteristics and parameters in this data sheet can and do vary in different applications and actual device performance may vary over time.
Users should verify actual device performance in their specific applications.

SRF2012AA Series - Common Mode Chip Inductors

BOURNS®

Typical Impedance vs. Frequency Curves (Continued)

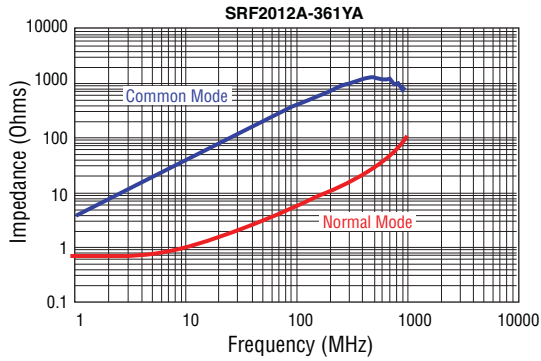

Packaging Specifications

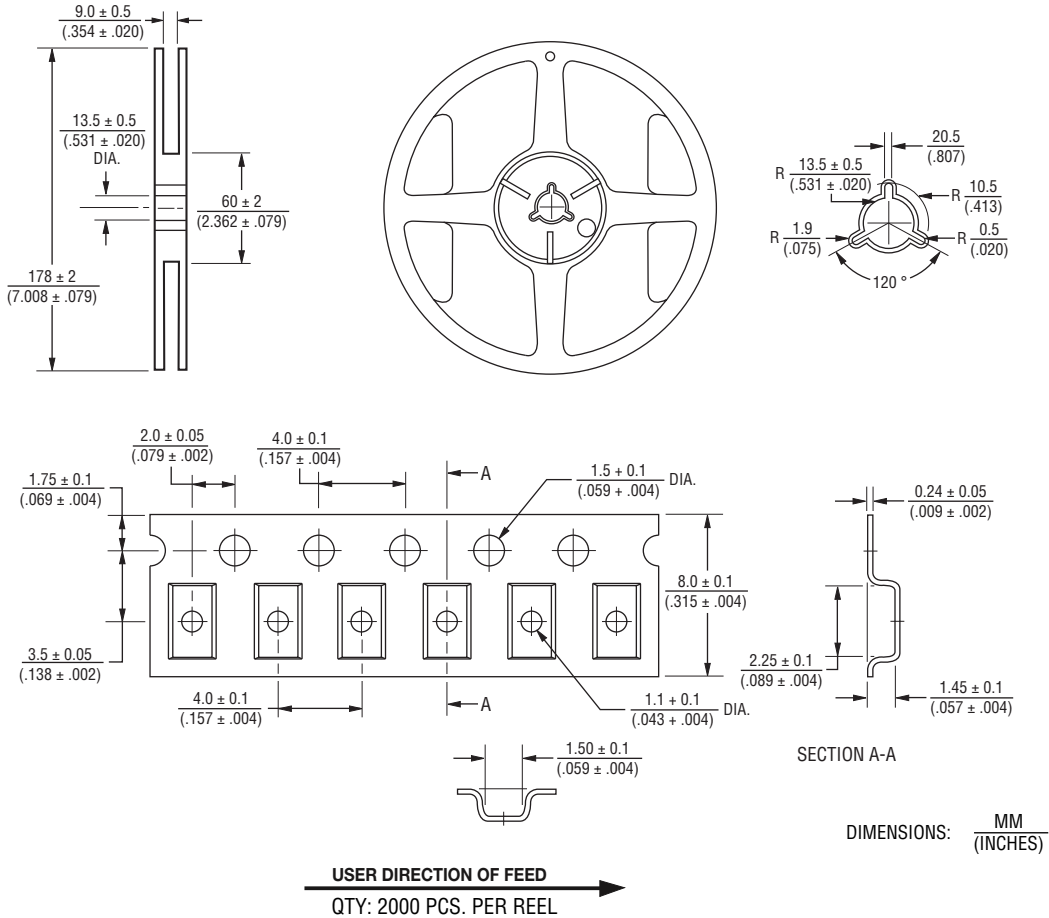

08/15

Specifications are subject to change without notice.
The device characteristics and parameters in this data sheet can and do vary in different applications and actual device performance may vary over time.
Users should verify actual device performance in their specific applications.

Looking for pricing, stock, or lifecycle information?

Click below to explore more details on WIN SOURCE:

 [View SRF2012A-900YA on WIN SOURCE](#)

 [Bourns Inc. Information](#)

Optimize Your Supply Chain with WIN SOURCE Solutions

-  Global Sourcing Solution
-  Obsolete Management
-  Cost Control Management
-  Shortage Management
-  Alternative Solution
-  Excess Inventory Management