

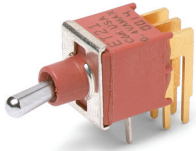

**THE DATASHEET OF
ET01SD1CBE**



ET Series Sealed Subminiature Toggle Switches



Features/Benefits

- Sealed against solder and cleaning process contaminants
- ESD protection available
- Thru-hole and surface mount models
- Compact size and small footprint save PCB space
- RoHS compliant models available

Typical Applications

- Hand-held telecommunications
- Instrumentation
- Medical equipment

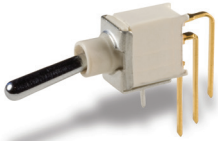

Specifications

CONTACT RATING: B contact material: 0.4 VA max. @ 20 V AC or DC max. See page F-35 for additional ratings.

ELECTRICAL LIFE: ETX1 models: 60,000 make-and-break cycles at full load. All other models: 30,000 cycles.

CONTACT RESISTANCE: Below 20 m Ω typ. initial @ 2-4 V DC, 100 mA, for both silver and gold plated contacts.

INSULATION RESISTANCE: 10⁹ Ω min.

ELECTROSTATIC DISCHARGE (ESD) RESISTANT OPTION: M3 & S3 insulating actuator only: 9,000 V DC min. @ sea level, actuator to terminals. F1 conductive bushing only: Dissipates up to 20,000 V DC from actuator to ground. M3 & S3 actuator and F1 bushing options are not recommended for use together.

DIELECTRIC STRENGTH: 1000 Vrms min. @ sea level.

OPERATING TEMPERATURE: -30°C to 85°C.

SOLDERABILITY: Per MIL-STD-202F method 208D, or EIA RS-186E method 9 (1 hour steam aging).

DEGREE OF PROTECTION: IP57; Protection against harmful dust deposit, full-scale voltage protection, temporary immersion.

PACKAGING: Surface mount switches are shipped in tape and reel packaging, see page F-36 for drawings and reel information.

Materials

CASE & BUSHING: Glass filled nylon 6/6, flame retardant, heat stabilized (UL 94V-0) or glass filled 4/6 nylon, flame retardant, heat stabilized (UL 94V-0). F1 conductive bushing option is impregnated with carbon fibers.

ACTUATOR: M3 & S3 anti-static actuator: Nylon 4/6, black standard (UL 94V-0). All other actuators: Brass, chrome plated. Internal o-ring seal standard with all actuators.

SWITCH SUPPORT: Brass, tin plated.

CONTACTS & TERMINALS: B contact material: Copper alloy, with gold plate over nickel plate. Q contact material: Copper alloy, silver plated. See F-35 for additional contact materials.

TERMINAL SEAL: Epoxy.

NOTE: Any models supplied with Q, B, G, P or R contact material are RoHS compliant and compatible.

NOTE: Specifications and materials listed above are for switches with standard options. For information on specific and custom switches, consult Customer Service Center.

Build-A-Switch

To order, simply select desired option from each category and place in the appropriate box. Available options are shown and described on pages F-31 thru F-36. For additional options not shown in catalog, consult our Customer Service Center. All models are process sealed to withstand machine soldering temperatures and pressure wash cleaning methods.



Switch Function

- ET01** SP, On-None-On
- ET02** SPST, Off-None-On
- ET03** SP, On-Off-On
- ET05** SP, Mom.-Off-Mom.
- ET07** SP, On-Off-Mom.
- ET08** SP, On-None-Mom.
- ET21** DP, On-None-On
- ET23** DP, On-Off-On
- ET24** DP, On-On-On
- ET25** DP, Mom.-Off-Mom.
- ET27** DP, On-Off-Mom.
- ET28** DP, On-None-Mom.

Actuator

- M** .240" high
- M3** Plastic, anti-static, .240" high
- S** .400" high
- L** .320" high
- S1** .550" high

Bushing

- D1** .177" High, Unthreaded
- F1** .177" high, unthreaded, ESD conductive

Terminations

- A** Right angle, PC thru-hole
- AV** Vertical right angle, PC thru-hole
- C** PC Thru-hole
- SA** Right angle, surface mount
- SA1** Right angle, surface mount rear-facing
- V3** Vertical mount, V-bracket
- AV3** Vertical right angle, snap-in, PC thru-hole
- V31** Vertical mount, V-bracket, snap-in
- W** Wire wrap

Contact Material

- B** Gold
- P** Gold, matte tin
- Q** Silver
- S** Silver/matte-tin
- G** Gold over silver
- R** Gold over silver, matte-tin

Seal

- E** Epoxy

Plastic Actuator Color

- NONE** No actuator color
- 1** White

Toggle
F



ET Series Sealed Subminiature Toggle Switches

SWITCH FUNCTION

NO. POLES	MODEL NO.	SWITCH FUNCTION			CONNECTED TERMINALS			SCHEMATIC
		POS. 1	POS. 2	POS. 3	POS. 1	POS. 2	POS. 3	
		C&K marking on opposite side			C&K marking on opposite side			
SP	ET01	ON	NONE	ON	2-3	N/A	2-1	
	ET03	ON	OFF	ON	2-3	OPEN	2-1	
	ET05	MOM.	OFF	MOM.				
	ET07	ON	OFF	MOM.				
	ET08	ON	NONE	MOM.				
	ET02	OFF	NONE	ON	OPEN	N/A	3-1	
<p>SPDT</p> <p>Part number shown: ET01MD1CBE ET02 Models: Omit terminal 2</p>								
DP	ET21	ON	NONE	ON	2-3,5-6	N/A	2-1,5-4	
	ET23	ON	OFF	ON	2-3,5-6	OPEN	2-1,5-4	
	ET25	MOM.	OFF	MOM.				
	ET27	ON	OFF	MOM.				
	ET28	ON	NONE	MOM.				
	ET24**	ON	ON	ON	2-3,5-6	2-3,5-4	2-1,5-4	
<p>DPDT</p> <p>Part number shown: ET21MD1CBE</p>								

MOM. = Momentary

** [Wiring for 3-way switch](#)

All models with all options (except M3 actuator) when ordered with G, L, R or Q contact material except with F1 conductive bushing.

ET Series Sealed Subminiature Toggle Switches

ACTUATOR

M .240" HIGH

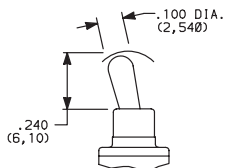

Standard with A, AV, V3 & V31 terminations.

M3 PLASTIC, ANTISTATIC,
.240" HIGH

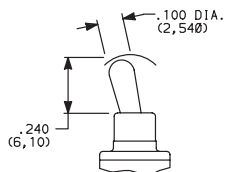

Material: Nylon 4/6 (UL 94V-0), black standard. Static resistance: 9,000 V DC min. @ sea level, actuator to terminals. Not available with F1 conductive bushing option. Not UL approved.

S .400" HIGH

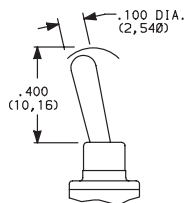

Standard with C or W terminations.

L .320" HIGH

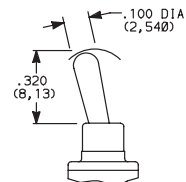

S1 .550" HIGH

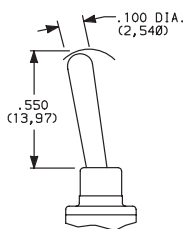

OPTION CODE	PLASTIC ACTUATOR COLOR
(NONE)	BLACK (M3 only)
1	WHITE (M3 only)

NOTE: All actuators have chrome finish (except M3 & S3).

BUSHING

D1 .177" HIGH, UNTHREADED

F1 ESD, CONDUCTIVE BUSHING
UNTHREADED, .177" HIGH

F1 bushing is not UL approved

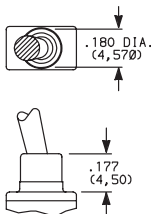

NOTE: ESD protection depends on proper grounding of switch support bracket. F1 conductive bushing option is impregnated with carbon fibers; dissipates electrostatic discharge (ESD) up to 20,000 V from actuator to ground.

Available with all metal actuator options and A, AV, AV3, V3 and V31 termination options only.

Internal actuator o-ring seal standard.

TERMINATIONS

C PC THRU-HOLE

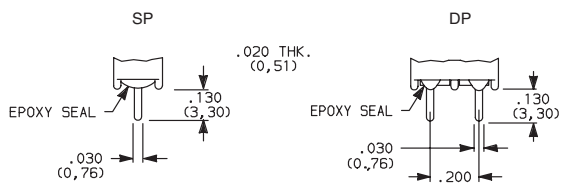

PC MOUNTING

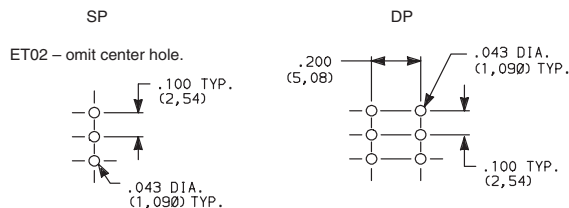

SP and DP

Not available with F1 conductive bushing.

W WIRE WRAP

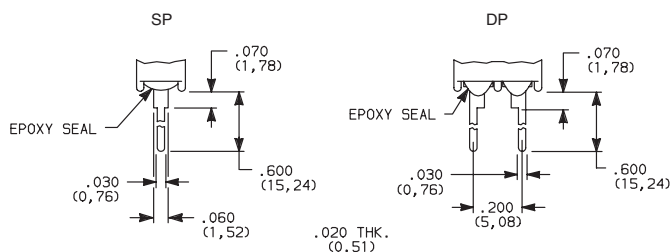

SP and DP

Not available with F1 conductive bushing.

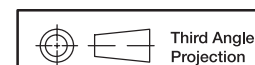

Dimensions are shown: Inches (mm)

Specifications and dimensions subject to change

ET Series Sealed Subminiature Toggle Switches

TERMINATIONS

A RIGHT ANGLE, PC THRU-HOLE

ET01MD1ABE
Horizontal Actuation
SPDT

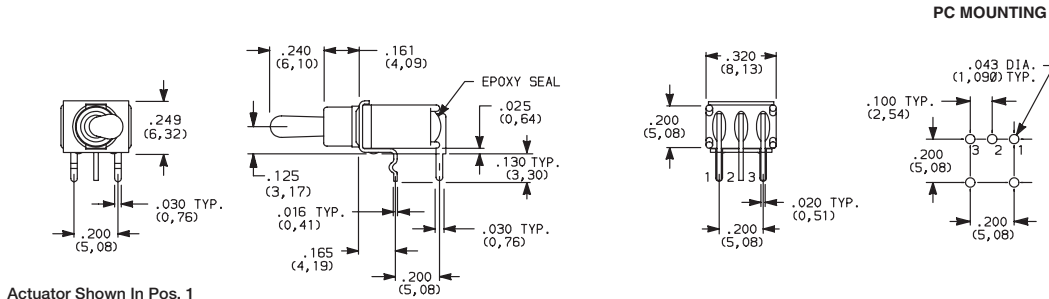

Not available with ET02 model.

A RIGHT ANGLE, PC THRU-HOLE

ET21MD1ABE
Horizontal Actuation
DPDT

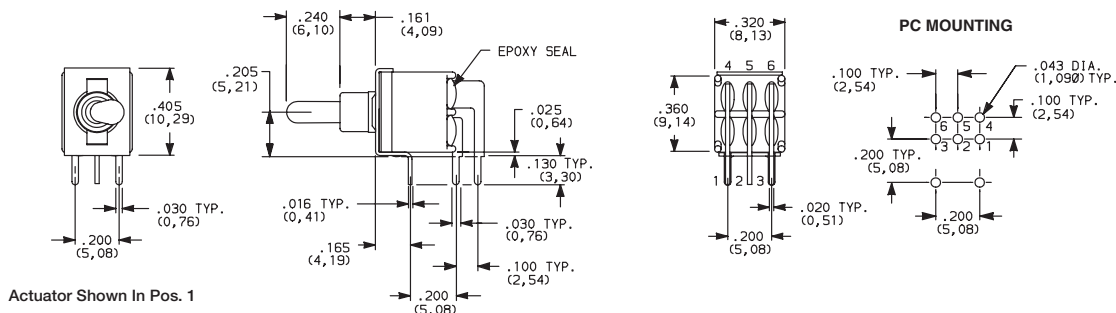

AV VERTICAL RIGHT ANGLE, PC THRU-HOLE

ET01MD1AVBE
Vertical Actuation
SPDT

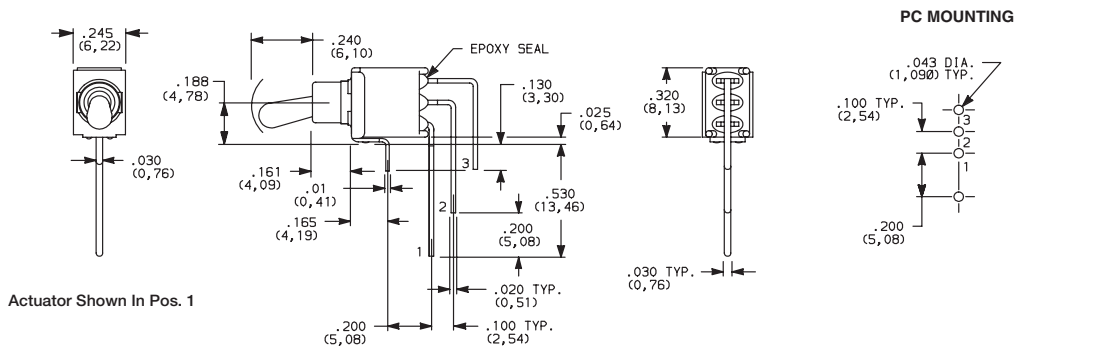

ET02 - omit terminal 2.

NOTE: Terminal bend radii and lead-in manufacturing option.

AV VERTICAL RIGHT ANGLE, PC THRU-HOLE

ET21MD1AVBE
Vertical Actuation
DPDT

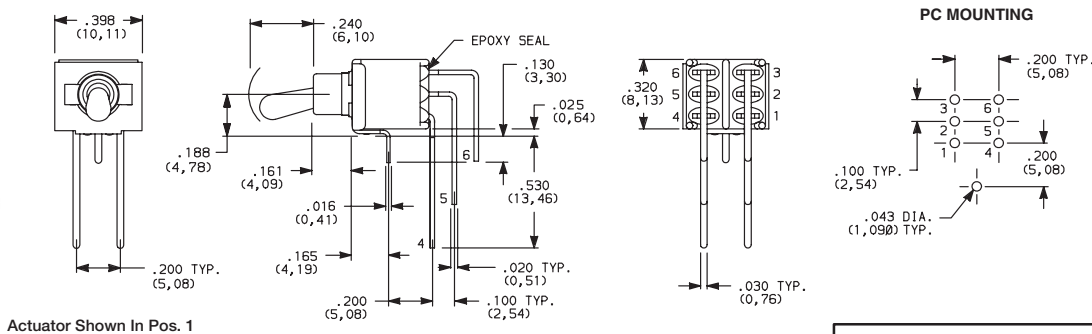

NOTE: Terminal bend radii and lead-in manufacturing option.



Dimensions are shown: Inches (mm)
Specifications and dimensions subject to change

ET Series Sealed Subminiature Toggle Switches

TERMINATIONS

AV3 VERTICAL RIGHT ANGLE, SNAP-IN, PC THRU-HOLE

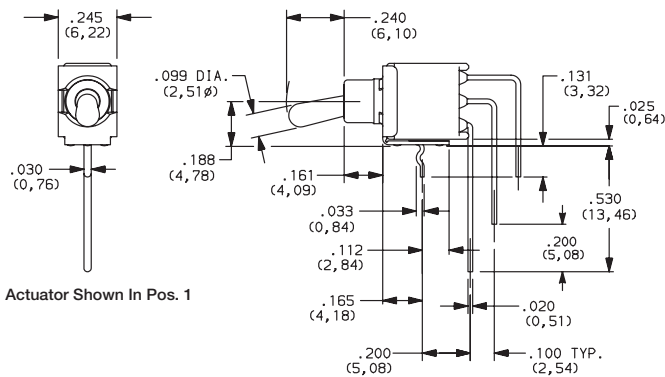

PC MOUNTING

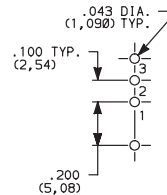

ET01SD1AV2BE
Vertical Actuation
SPDT

SA RIGHT ANGLE, SURFACE MOUNT

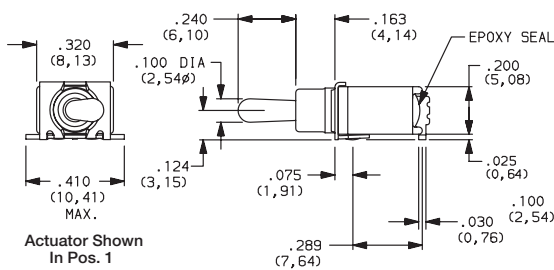

PC MOUNTING

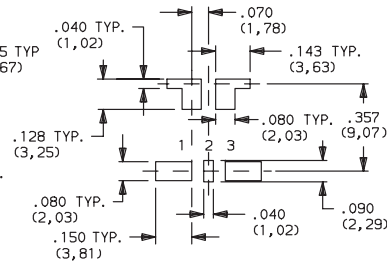

ET01M3D1SAPE
Horizontal Actuation
SPDT Only

Not available with S and S1 actuators. Standard with tape & reel packaging. See page F-36.

SA1 RIGHT ANGLE, SURFACE MOUNT

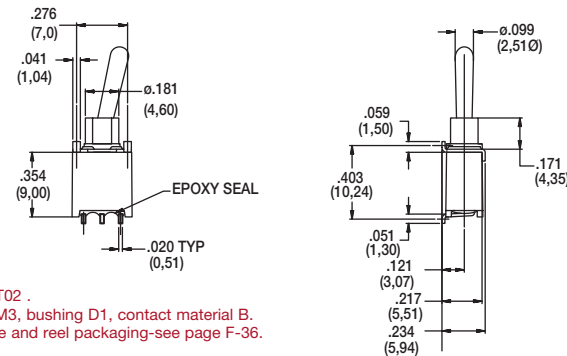

Not available in ET02.
Actuators M and M3, bushing D1, contact material B.
Standard with tape and reel packaging-see page F-36.

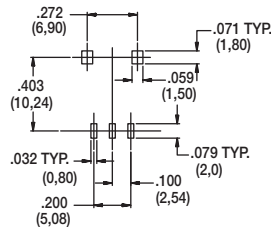

ET01M3D1SA1BE
Horizontal Actuation
SPDT Only

V3 VERTICAL MOUNT, V-BRACKET

V31 VERTICAL MOUNT, V-BRACKET, SNAP-IN

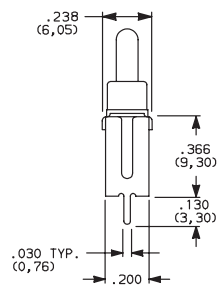
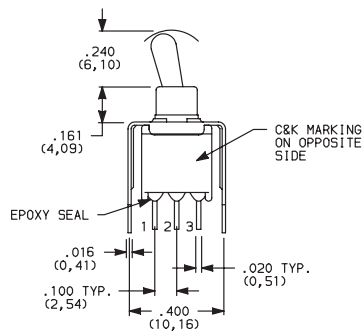

PC MOUNTING

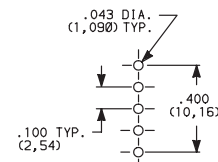

ET02 Models: Omit center hole

ET01MD1V3BE
SPDT

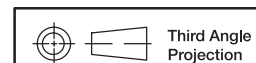

Dimensions are shown: Inches (mm)
Specifications and dimensions subject to change

www.ckswitches.com

ET Series Sealed Subminiature Toggle Switches

TERMINATIONS

V3 VERTICAL MOUNT, V-BRACKET

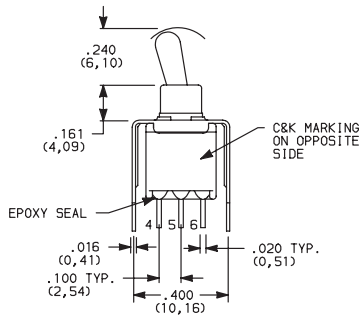

Actuator Shown In Pos. 1

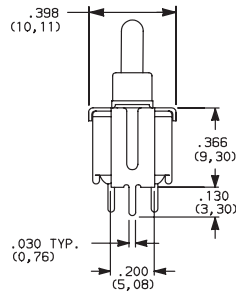

PC MOUNTING

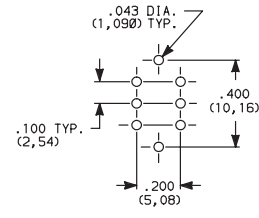

ET21MD1V3BE
DPDT

CONTACT MATERIAL

OPTION CODE	CONTACT MATERIAL	TERMINAL PLATING	RATINGS	
B	GOLD 1	GOLD 1	LOW LEVEL/DRY CIRCUIT	0.4 VA MAX. @ 20 V AC OR DC MAX.
P		MATTE-TIN 6		
Q	SILVER 4,5	SILVER 5	POWER	ETX1 MODELS: 3 AMPS @ 120 V AC OR 28 V DC ALL OTHER MODELS: 2 AMPS @ 120 V AC OR 28 V DC
S		MATTE-TIN 6		
G	GOLD OVER SILVER 2,3	GOLD 3	LOW LEVEL/DRY CIRCUIT OR POWER	ETX1 MODELS: 0.4 VA MAX. @ 20 V AC OR DC MAX. OR 3 AMPS @ 120 V AC OR 28 V DC ALL OTHER MODELS: 0.4 VA MAX. @ 20 V AC OR DC MAX. OR 2 AMPS @ 120 V AC OR 28 V DC
R		MATTE-TIN 6		

* Note: See Technical Data section of this catalog for RoHS compliant and compatible definitions and specifications.

- CONTACTS & TERMINALS: Copper alloy, with gold plate over nickel plate.
- END CONTACTS: Coin silver, with gold plate over nickel plate.
- CENTER CONTACTS & ALL TERMINALS: Copper alloy, with gold plate over nickel plate.
- END CONTACTS: Coin silver, silver plated.
- CENTER CONTACT & ALL TERMINALS: Copper alloy, silver plated.
- TERMINALS: Copper alloy, with matte tin over nickel plate.

NOTE: Any models supplied with Q, B, G, P or R contact material are RoHS compliant.

All models  with all options (except M3 actuator) when ordered with G, L, R or Q contact material except with F1 conductive bushing.

SEAL

E EPOXY SEAL

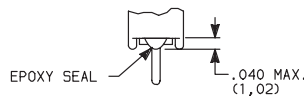

AVAILABLE HARDWARE

Cap

PART NO.
706201000 WHITE
706202000 BLACK
706203000 RED

Material: Vinyl
 Finish: Matte

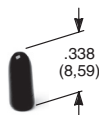

NOTE: Other colors available, consult Customer Service Center.

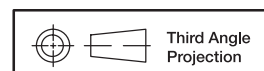

Third Angle
Projection

Dimensions are shown: Inches (mm)
 Specifications and dimensions subject to change



F

Toggle

ET Series Sealed Subminiature Toggle Switches

TAPE & REEL

For part number ET01M3D1SAPE

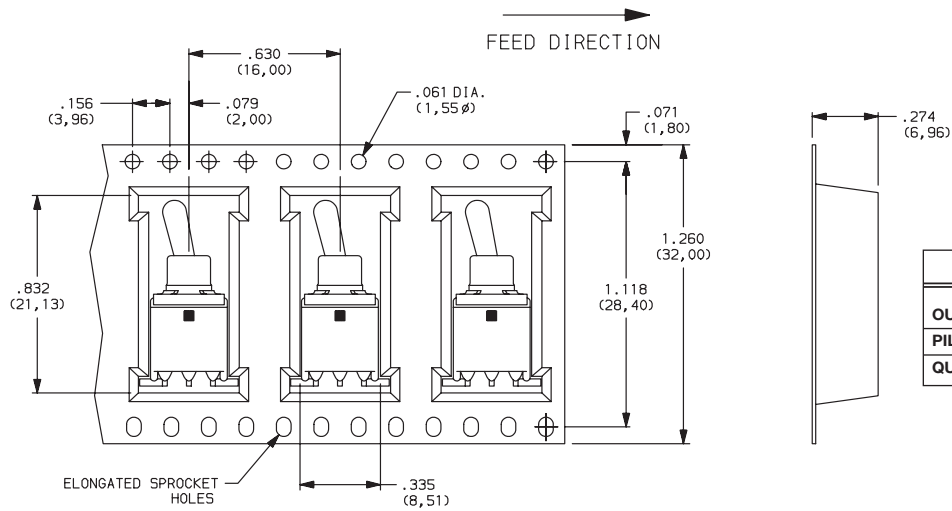

REEL INFORMATION	
OUTSIDE DIAMETER	13.00 (330,0)
PILOT HOLE	.512 (13,0)
QUANTITY PER REEL	600

For part number ET01M3D1SA1BE

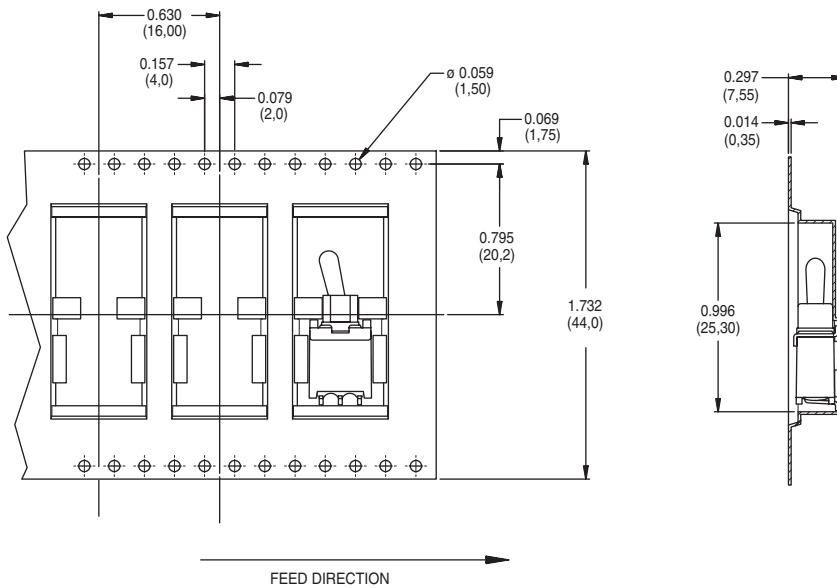

REEL INFORMATION	
OUTSIDE DIAMETER	13.00 (330,0)
PILOT HOLE	.795 (20,20)
QUANTITY PER REEL	500



T

Toggle



26 Mar 21

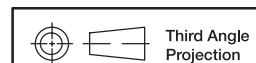

Dimensions are shown: Inches (mm)
Specifications and dimensions subject to change

Looking for pricing, stock, or lifecycle information?

Click below to explore more details on WIN SOURCE:

- ⊖ [View ET01SD1CBE](#) on WIN SOURCE
- ⊖ [C&K Components](#) Information

Optimize Your Supply Chain with WIN SOURCE Solutions

- ✓ Global Sourcing Solution
- ✓ Obsolete Management
- ✓ Cost Control Management
- ✓ Shortage Management
- ✓ Alternative Solution
- ✓ Excess Inventory Management