



**THE DATASHEET OF
BMR4570004/001**



BMR457 series Fully regulated Advanced Bus Converters
Input 36-75 V, Output up to 25 A / 300 W

1/28701-FGC 101 1835 revE September 2017

© Flex

Key Features

- Advanced Bus Converter Industry standard Eighth-brick with digital PMBus interface
58.4 x 22.7 x 10.2 mm (2.30 x 0.89 x 0.40 in.)
- Optional industry standard 5-pins for intermediate bus architectures
- Industry-leading Power Density for Telecom and Datacom 129-147W / sq. in
- Flex DC/DC Energy Optimizer built-in
- High efficiency, typ. 95.2% at half load, 12 Vout
- Fully regulated Advanced Bus Converter from 36-75Vin
- 2250 Vdc input to output isolation
- Fast Feed forward regulation to manage line transients
- Optional baseplate for high temperature applications
- Droop Load Sharing with 10% current share accuracy
- PMBus Revision 1.2 compliant
- 2.9 million hours MTBF
- ISO 9001/14001 certified supplier

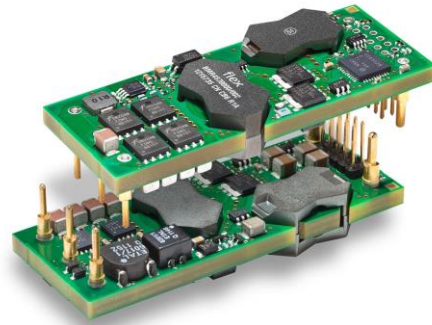

Power Management

- Configurable soft start/stop
- Precision delay and ramp-up
- Voltage margining
- Voltage/current/temperature monitoring
- Wide output voltage range
- Configurable protection features



Safety Approvals



Design for Environment



Meets requirements in high-temperature lead-free soldering processes

Contents

| | |
|-------------------------------------|--------------------------|
| Ordering Information | 2 |
| General Information | 2 |
| Safety Specification | 4 |
| Absolute Maximum Ratings | 5 |
| Electrical Specification | |
| 12 V, 22 A / 264 W (36-75Vin) | BMR 457 0004/001..... 7 |
| 12 V, 25 A / 300 W (40-60Vin) | BMR 457 0000/002..... 11 |
| 12.45 V, 22 A / 261 W (36-75Vin) | BMR 457 0007/014..... 15 |
| 12.45 V, 25 A / 296 W (40-60Vin) | BMR 457 0011/017..... 18 |
| EMC Specification | 21 |
| Operating Information | 22 |
| Thermal Consideration | 25 |
| Connections | 26 |
| PMBus Interface | 27 |
| Mechanical Information | 30 |
| Soldering Information | 33 |
| Delivery Information | 34 |
| Product Qualification Specification | 36 |

BMR457 series Fully regulated Advanced Bus Converters
 Input 36-75 V, Output up to 25 A / 300 W

 1/28701-FGC 101 1835 revE September 2017
 © Flex

Ordering Information

| Product program | Vin | Output |
|-----------------|---------|-----------------------|
| BMR4570004/001 | 36 – 75 | 12 V / 22 A, 264 W |
| BMR4570007/013 | 36 – 75 | 12 V / 22 A, 251 W |
| BMR4570007/014 | 36 – 75 | 12.45 V / 22 A, 261 W |
| BMR4570000/002 | 40 – 60 | 12 V / 25 A, 300 W |
| BMR4570011/016 | 40 - 60 | 12 V / 25 A, 285 W |
| BMR4570011/017 | 40 - 60 | 12.45 V / 25 A, 296 W |

Product Number and Packaging

| BMR457 n ₁ n ₂ n ₃ n ₄ / n ₅ n ₆ n ₇ | | | | | | | | |
|---|----------------|----------------|----------------|----------------|---|----------------|----------------|----------------|
| Options | n ₁ | n ₂ | n ₃ | n ₄ | / | n ₅ | n ₆ | n ₇ |
| Mechanical pin option | x | | | | / | | | |
| Mechanical option | | x | | | / | | | |
| Hardware option | | | x | x | / | | | |
| Configuration file | | | | | / | x | x | x |

| Optional designation | Description |
|--|--|
| n ₁ | 0 = Standard pin length 5.33 mm 1 = Surface mount option ^{note 1} 2 = Lead length 3.69 mm(0.145 in.) (cut) 3 = Lead length 4.57 mm(0.180 in.) (cut) 4 = Lead length 2.79 mm(0.110 in.) (cut) |
| n ₂ | 0 = Open frame 1 = Baseplate |
| n ₃ n ₄ | 00 = 40-60 Vin, 6.9-13.2 Vout adjusted, with digital interface 01 = 40-60 Vin, 6.9-13.2 Vout adjusted, without digital interface 04 = 36-75 Vin, 6.9-13.2 Vout adjusted, with digital interface 05 = 36-75 Vin, 6.9-13.2 Vout adjusted, without digital interface 06 = 36-75 Vin, 6.9-13.2 Vout adjusted, Droop load sharing function for parallel operation, without digital interface 07 = 36-75 Vin, 6.9-13.2 Vout adjusted, Droop load sharing function for parallel operation, with digital interface 11 = 40-60 Vin, 6.9-13.2 Vout adjusted, Droop load sharing function for parallel operation, with digital interface 12 = 40-60 Vin, 6.9-13.2 Vout adjusted, Droop load sharing function for parallel operation, without digital interface |
| n ₅ n ₆ n ₇ | 001 = 12 V Standard configuration for 36-75 Vin, n ₃ n ₄ = 04 or 05 |

002 = 12 V Standard configuration for 40-60 Vin, n₃n₄ = 00 or 01
 008 = 12 V with positive RC logic configuration for 36-75 Vin, n₃n₄ = 04 or 05
 009 = 12 V with positive RC logic configuration for 40-60 Vin, n₃n₄ = 00 or 01
 013 = 12 V with 0.6 V droop load sharing function configuration (36-75 Vin, n₃n₄ = 06 or 07)
 014 = 12.45 V with 0.6V droop load sharing function configuration (36-75 Vin, n₃n₄ = 06 or 07)
 016 = 12 V with 0.6 V droop load sharing function configuration (40-60 Vin, n₃n₄ = 11 or 12)
 017 = 12.45 V with 0.6V droop load sharing function configuration (40-60 Vin, n₃n₄ = 11 or 12)

xxx = Application Specific Configuration

Packaging 25 converters(through hole pin)/tray, PE foam dissipative
 20 converters(surface mount pin)/tray, Antistatic PPE

Example: Product number BMR4572004/001 equals an Through hole mount lead length 3.69 mm (cut), open frame, digital interface with 12 V standard configuration variant.

Note 1: No baseplate option

For application specific configurations contact your local Flex sales representative.

General Information
Reliability

The failure rate (λ) and mean time between failures (MTBF = $1/\lambda$) is calculated at max output power and an operating ambient temperature (T_A) of +40°C. Flex uses Telcordia SR-332 Issue 2 Method 1 to calculate the mean steady-state failure rate and standard deviation (σ).

Telcordia SR-332 Issue 2 also provides techniques to estimate the upper confidence levels of failure rates based on the mean and standard deviation.

| Mean steady-state failure rate, λ | Std. deviation, σ |
|---|--------------------------|
| 421 n Failures/h | 60.9 n Failures/h |

MTBF (mean value) for the BMR457 series = 2.91 Mh.
 MTBF at 90% confidence level = 2.37 Mh

Compatibility with RoHS requirements

The products are compatible with the relevant clauses and requirements of the RoHS directive 2011/65/EU and have a maximum concentration value of 0.1% by weight in homogeneous materials for lead, mercury, hexavalent chromium, PBB and PBDE and of 0.01% by weight in homogeneous materials for cadmium.

BMR457 series Fully regulated Advanced Bus Converters
Input 36-75 V, Output up to 25 A / 300 W

1/28701-FGC 101 1835 revE September 2017

© Flex

Exemptions in the RoHS directive utilized in Flex products are found in the Statement of Compliance document.

Flex fulfills and will continuously fulfill all its obligations under regulation (EC) No 1907/2006 concerning the registration, evaluation, authorization and restriction of chemicals (REACH) as they enter into force and is through product materials declarations preparing for the obligations to communicate information on substances in the products.

Quality Statement

The products are designed and manufactured in an industrial environment where quality systems and methods like ISO 9000, Six Sigma, and SPC are intensively in use to boost the continuous improvements strategy. Infant mortality or early failures in the products are screened out and they are subjected to an ATE-based final test. Conservative design rules, design reviews and product qualifications, plus the high competence of an engaged work force, contribute to the high quality of the products.

Warranty

Warranty period and conditions are defined in Flex General Terms and Conditions of Sale.

Limitation of Liability

Flex does not make any other warranties, expressed or implied including any warranty of merchantability or fitness for a particular purpose (including, but not limited to, use in life support applications, where malfunctions of product can cause injury to a person's health or life).

© Flex 2017

The information and specifications in this technical specification is believed to be correct at the time of publication. However, no liability is accepted for inaccuracies, printing errors or for any consequences thereof. Flex reserves the right to change the contents of this technical specification at any time without prior notice.

| | |
|--|--|
| BMR457 series Fully regulated Advanced Bus Converters Input 36-75 V, Output up to 25 A / 300 W | 1/28701-FGC 101 1835 revE September 2017 |
| | © Flex |

Safety Specification

General information

Flex DC/DC converters and DC/DC regulators are designed in accordance with the safety standards IEC 60950-1, EN 60950-1 and UL 60950-1 *Safety of Information Technology Equipment*.

IEC/EN/UL 60950-1 contains requirements to prevent injury or damage due to the following hazards:

- Electrical shock
- Energy hazards
- Fire
- Mechanical and heat hazards
- Radiation hazards
- Chemical hazards

On-board DC/DC converters and DC/DC regulators are defined as component power supplies. As components they cannot fully comply with the provisions of any safety requirements without "conditions of acceptability". Clearance between conductors and between conductive parts of the component power supply and conductors on the board in the final product must meet the applicable safety requirements. Certain conditions of acceptability apply for component power supplies with limited stand-off (see Mechanical Information for further information). It is the responsibility of the installer to ensure that the final product housing these components complies with the requirements of all applicable safety standards and regulations for the final product.

Component power supplies for general use should comply with the requirements in IEC/EN/UL 60950-1 *Safety of Information Technology Equipment*. Product related standards, e.g. IEEE 802.3af *Power over Ethernet*, and ETS-300132-2 *Power interface at the input to telecom equipment, operated by direct current (dc)* are based on IEC/EN/UL 60950-1 with regards to safety.

Flex DC/DC converters and DC/DC regulators are UL 60950-1 recognized and certified in accordance with EN 60950-1. The flammability rating for all construction parts of the products meet requirements for V-0 class material according to IEC 60695-11-10, *Fire hazard testing, test flames* – 50 W horizontal and vertical flame test methods.

Isolated DC/DC converters

Galvanic isolation between input and output is verified in an electric strength test and the isolation voltage (V_{iso}) meets the voltage strength requirement for basic insulation according to IEC/EN/UL 60950-1.

It is recommended to use a slow blow fuse at the input of each DC/DC converter. If an input filter is used in the circuit the fuse should be placed in front of the input filter. In the rare event of a component problem that imposes a short

circuit on the input source, this fuse will provide the following functions:

- Isolate the fault from the input power source so as not to affect the operation of other parts of the system
- Protect the distribution wiring from excessive current and power loss thus preventing hazardous overheating

The DC/DC converter output is considered as safety extra low voltage (SELV) if one of the following conditions is met:

- The input source has double or reinforced insulation from the AC mains according to IEC/EN/UL 60950-1
- The input source has basic or supplementary insulation from the AC mains and the input of the DC/DC converter is maximum 60 Vdc and connected to protective earth according to IEC/EN/UL 60950-1
- The input source has basic or supplementary insulation from the AC mains and the DC/DC converter output is connected to protective earth according to IEC/EN/UL 60950-1

Non - isolated DC/DC regulators

The DC/DC regulator output is SELV if the input source meets the requirements for SELV circuits according to IEC/EN/UL 60950-1.

BMR457 series Fully regulated Advanced Bus Converters
 Input 36-75 V, Output up to 25 A / 300 W

1/28701-FGC 101 1835 revE September 2017

© Flex

Absolute Maximum Ratings

| Characteristics | | min | typ | max | Unit |
|------------------|---|------|-----|--------------|------|
| T _{P1} | Operating Temperature (see Thermal Consideration section) | -40 | | +125 | °C |
| T _S | Storage temperature | -55 | | +125 | °C |
| V _I | Input voltage | -0.5 | | +80 +65* | V |
| C _{out} | Output capacitance | 100 | | | µF |
| V _{iso} | Isolation voltage (input to output test voltage) | | | 2250 | Vdc |
| V _{iso} | Isolation voltage (input to baseplate qualification test voltage) | | | 750 | Vdc |
| V _{iso} | Isolation voltage (baseplate to output qualification test voltage) | | | 750 | Vdc |
| V _{tr} | Input voltage transient according to ETSI EN 300 132-2 and Telcordia GR-1089-CORE | | | +100 +80* | V |
| V _{RC} | Remote Control pin voltage (see Operating Information section) | -0.3 | | 18 | V |
| V Logic I/O | SALERT, CTRL, SCL, SDA, SA0, SA1 | -0.3 | | 3.6 | V |

Stress in excess of Absolute Maximum Ratings may cause permanent damage. Absolute Maximum Ratings, sometimes referred to as no destruction limits, are normally tested with one parameter at a time exceeding the limits in the Electrical Specification. If exposed to stress above these limits, function and performance may degrade in an unspecified manner.

*) Apply for the narrow input version V_I= 40-60 V.

Fundamental Circuit Diagram

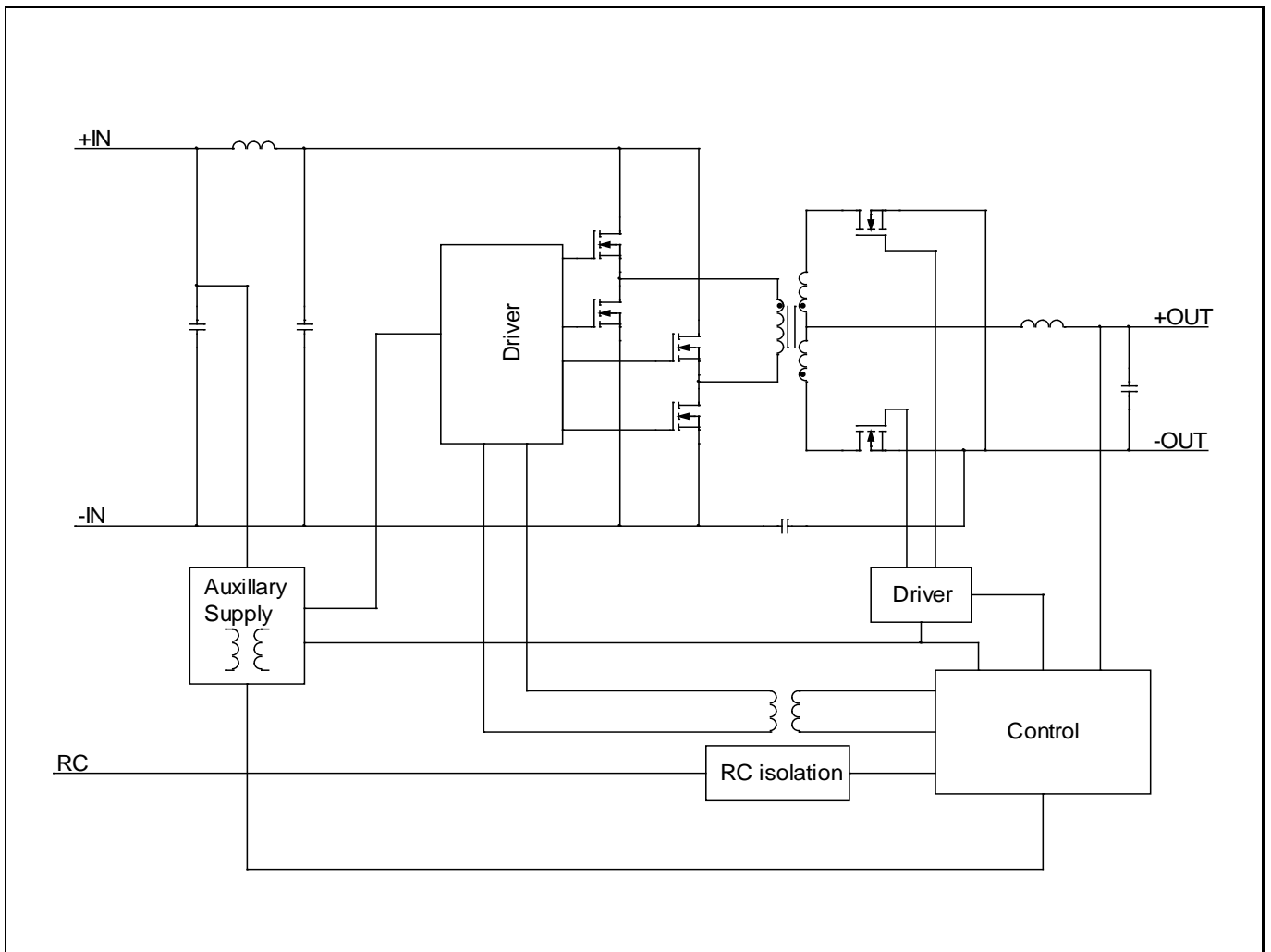

BMR457 series Fully regulated Advanced Bus Converters
 Input 36-75 V, Output up to 25 A / 300 W

1/28701-FGC 101 1835 revE September 2017
 © Flex

Functional Description

$T_{P1}, T_{P3} = -40$ to $+90^{\circ}\text{C}$, $V_I = 36$ to 75 V, sense pins connected to output pins unless otherwise specified under Conditions.
 Typical values given at: $T_{P1}, T_{P3} = +25^{\circ}\text{C}$, $V_I = 53$ V, max I_O , unless otherwise specified under Conditions
 Configuration File: 190 10-CDA 102 0315/001

| Characteristics | | Conditions | min | typ | max | Unit |
|---|-------------------------------|--|------------------|-----------|---------------|--------------------|
| PMBus monitoring accuracy | | | | | | |
| VIN_READ | Input voltage | | -2 | ± 0.5 | 2 | % |
| VOUT_READ | Output voltage | $V_I = 53$ V | -1.0 | ± 0.1 | 1.0 | % |
| IOUT_READ | Output current | $V_I = 53$ V, 50-100% of max I_O | -6 | ± 1.5 | 6 | % |
| | | $V_I = 53$ V, 10% of max I_O | -0.6 | - | 0.6 | A |
| TEMP_READ | Temperature | Controller IC internal sensor | 0 | 5 | 10 | $^{\circ}\text{C}$ |
| Fault Protection Characteristics | | | | | | |
| Input Under Voltage Lockout, UVLO | Factory default | | - | 32 | - | V |
| | Setpoint accuracy | | 0 | 0.5 | 1 | V |
| | Hysteresis | Factory default | - | 2 | - | V |
| | | Configurable via PMBus of threshold range, Note 1 | 0 | - | - | V |
| Delay | | - | 300 | - | μs | |
| (Output voltage) Over/Under Voltage Protection, OVP/UV | VOUT_UV_FAULT_LIMIT | Factory default | - | 0 | - | V |
| | | Configurable via PMBus, Note 1 | 0 | - | 16 | V |
| | VOUT_OV_FAULT_LIMIT | Factory default | - | 15.6 | - | V |
| | | Configurable via PMBus, Note 1 | V_{OUT} | - | 16 | V |
| fault response time | | - | 200 | - | μs | |
| Over Current Protection, OCP | Setpoint accuracy | I_O | -6 | - | 6 | % |
| | IOUT_OC_FAULT_LIMIT | Factory default | - | 25 | - | A |
| | | Configurable via PMBus, Note 1 | 0 | - | 100 | A |
| fault response time | | - | 200 | - | μs | |
| Over Temperature Protection, OTP | OTP_FAULT_LIMIT | Factory default | - | 125 | - | $^{\circ}\text{C}$ |
| | | Configurable via PMBus, Note 1 | -50 | - | 125 | |
| | OTP hysteresis | Factory default | - | 10 | - | |
| | | Configurable via PMBus, Note 1 | 0 | - | 125 | |
| fault response time | | - | 300 | - | μs | |
| Logic Input/Output Characteristics | | | | | | |
| Logic input low (V_{IL}) | CTRL, SA0, SA1, PG, SCL, SDA, | | - | - | 1.1 | V |
| Logic input high (V_{IH}) | | | 2.1 | - | - | V |
| Logic output low (V_{OL}) | CTRL, PG, SALERT, SCL, SDA | $I_{OL} = 6$ mA | - | - | 0.25 | V |
| Logic output high (V_{OH}) | CTRL, PG, SALERT, SCL, SDA | $I_{OH} = -6$ mA | 2.7 | - | - | V |
| Bus free time T(BUF) | Note 2 | | 1.3 | - | - | μs |

Note 1: See Operating Information section.

Note 2: PMBus timing parameters according to PMBus spec.

BMR457 series Fully regulated Advanced Bus Converters
 Input 36-75 V, Output up to 25 A / 300 W

1/28701-FGC 101 1835 revE September 2017
 © Flex

Electrical Specification
12 V, 22 A, 264 W

BMR457 0004/001

$T_{P1} = -40$ to $+90^{\circ}\text{C}$, $V_1 = 36$ to 75V , sense pins connected to output pins unless otherwise specified under Conditions.
 Typical values given at: $T_{P1} = +25^{\circ}\text{C}$, $V_1 = 53\text{V}$, $I_o = \text{max } I_o$, unless otherwise specified under Conditions.
 Additional $C_{in} = 0.1\text{mF}$, $C_{out} = 0.1\text{mF}$. See Operating Information section for selection of capacitor types.
 Configuration File: 19010-CDA 102 0315/001

| Characteristics | | Conditions | min | typ | max | Unit |
|-----------------|-----------------------------|---|-----|------|-----|---------------|
| V_1 | Input voltage range | | 36 | | 75 | V |
| V_{loff} | Turn-off input voltage | Decreasing input voltage | 32 | 33 | 34 | V |
| V_{lon} | Turn-on input voltage | Increasing input voltage | 34 | 35 | 36 | V |
| C_i | Internal input capacitance | | | 11 | | μF |
| P_o | Output power | | 0 | | 264 | W |
| η | Efficiency | 50% of I_o | | 94.7 | | % |
| | | I_o | | 94.5 | | |
| | | 50% of I_o , $V_1 = 48\text{V}$ | | 95.2 | | |
| | | I_o , $V_1 = 48\text{V}$ | | 94.8 | | |
| P_d | Power Dissipation | I_o | | 15.5 | 22 | W |
| P_{ii} | Input idling power | $I_o = 0\text{A}$, $V_1 = 53\text{V}$ | | 3.5 | | W |
| P_{RC} | Input standby power | $V_1 = 53\text{V}$ (turned off with RC) | | 0.4 | | W |
| f_s | Default switching frequency | 0-100% of I_o | 171 | 180 | 189 | kHz |

| | | | | | | |
|--------------|---|---|-------|-----------|-------|---------------|
| V_{α} | Output voltage initial setting and accuracy | $T_{P1} = +25^{\circ}\text{C}$, $V_1 = 53\text{V}$, $I_o = 12\text{A}$ | 11.88 | 12.0 | 12.12 | V |
| V_o | Output adjust range | See operating information | 6.9 | | 13.2 | V |
| | Output voltage tolerance band | 0-100% of I_o | 11.76 | | 12.24 | V |
| | Idling voltage | $I_o = 0\text{A}$ | 11.88 | | 12.12 | V |
| | Line regulation | I_o | | 100 | 200 | mV |
| | Load regulation | $V_1 = 53\text{V}$, 1-100% of I_o | | 30 | 100 | mV |
| V_{tr} | Load transient voltage deviation | $V_1 = 53\text{V}$, Load step 25-75-25% of I_o , $di/dt = 1\text{A}/\mu\text{s}$, $C_{out} = 2.2\text{mF}$ OSCON type | | ± 350 | | mV |
| t_{tr} | Load transient recovery time | | | 200 | | μs |
| t_r | Ramp-up time (from 10-90% of V_o) | 10-100% of I_o | | 8 | | ms |
| t_s | Start-up time (from V_1 connection to 90% of V_o) | | | 23 | | ms |
| t_f | V_1 shut-down fall time (from V_1 off to 10% of V_o) | I_o | | 0.7 | | ms |
| | | $I_o = 0\text{A}$ | | 6 | | s |
| t_{RC} | RC start-up time | I_o | | 12 | | ms |
| | RC shut-down fall time (from RC off to 10% of V_o) | I_o | | 3 | | ms |
| | | $I_o = 0\text{A}$ | | 6 | | s |
| I_o | Output current | | 0 | | 22 | A |
| I_{lim} | Current limit threshold | $V_o = 10.8\text{V}$, $T_{P1} < \text{max } T_{P1}$ | 24 | 25 | 26 | A |
| I_{sc} | Short circuit current | $T_{P1} = 25^{\circ}\text{C}$, see Note 1 | | 1.1 | | A |
| C_{out} | Recommended Capacitive Load | $T_{P1} = 25^{\circ}\text{C}$, see Note 2 | 0 | 2.2 | 6 | mF |
| V_{Oac} | Output ripple & noise | See ripple & noise section, V_{α} | | 50 | 100 | mVp-p |
| OVP | Over voltage protection | $T_{P1} = +25^{\circ}\text{C}$, $V_1 = 53\text{V}$, 10-100% of I_o | | 15.6 | | V |
| RC | Sink current, see Note 3 | See operating information | | | 0.7 | mA |
| | Trigger level | Decreasing / Increasing RC-voltage | | 2.6/2.9 | | V |

Note 1: OCP in hic-up mode

Note 2: Low ESR-value

Note 3: Sink current drawn by external device connected to the RC pin. Minimum sink current required to guarantee activated RC function.

BMR457 series Fully regulated Advanced Bus Converters
 Input 36-75 V, Output up to 25 A / 300 W

1/28701-FGC 101 1835 revE September 2017

© Flex

Typical Characteristics
 12 V, 22 A, 264 W

BMR 457 0004/001

Efficiency

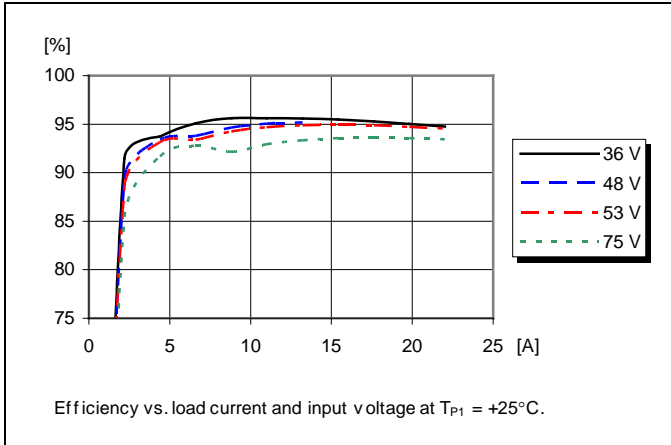

Power Dissipation

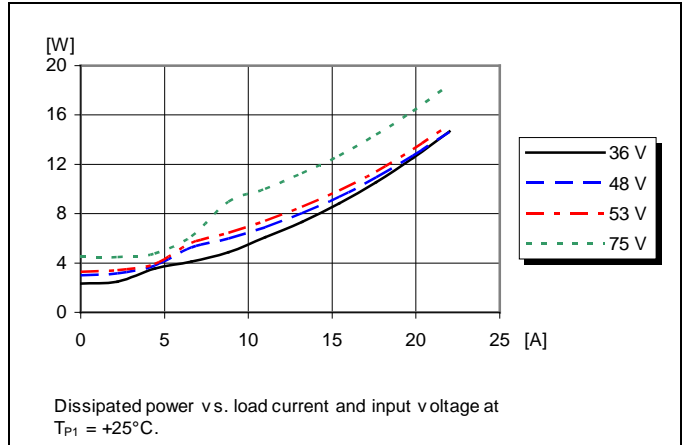

Output Characteristics

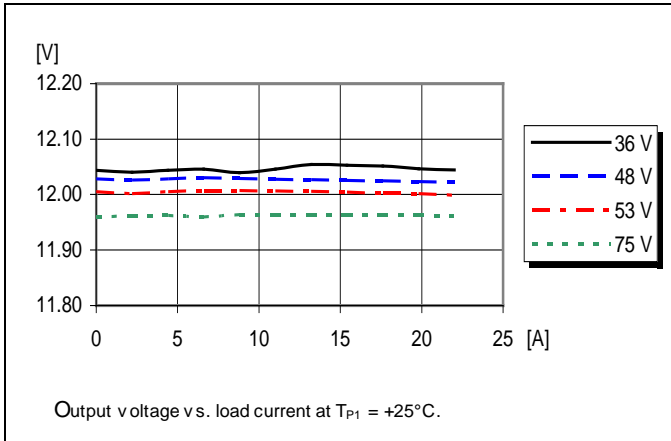

Current Limit Characteristics

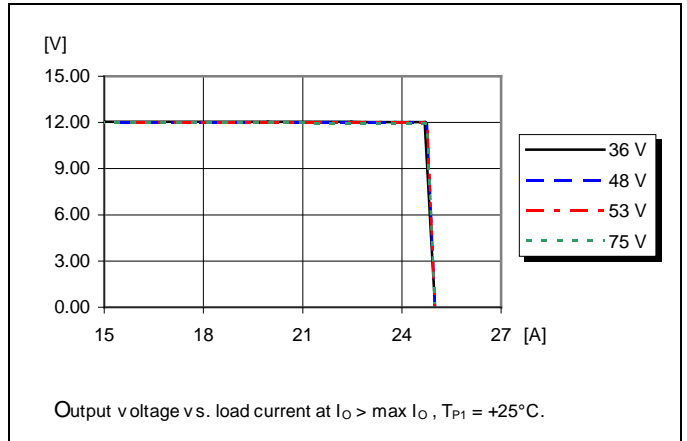

BMR457 series Fully regulated Advanced Bus Converters
 Input 36-75 V, Output up to 25 A / 300 W

1/28701-FGC 101 1835 revE September 2017

© Flex

Typical Characteristics 12 V, 22 A, 264 W

BMR 457 0004/001

Start-up

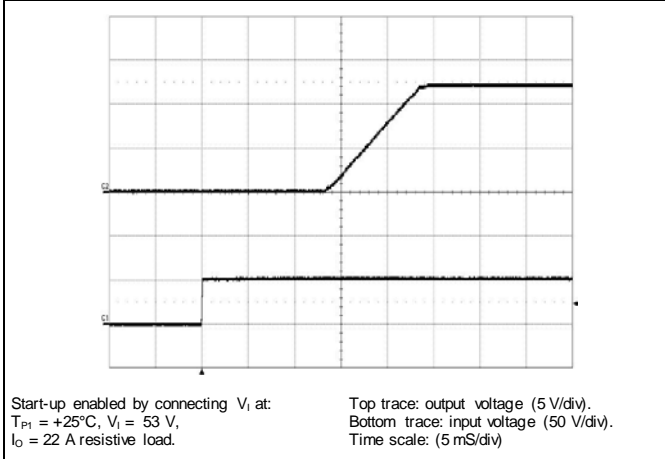

Shut-down

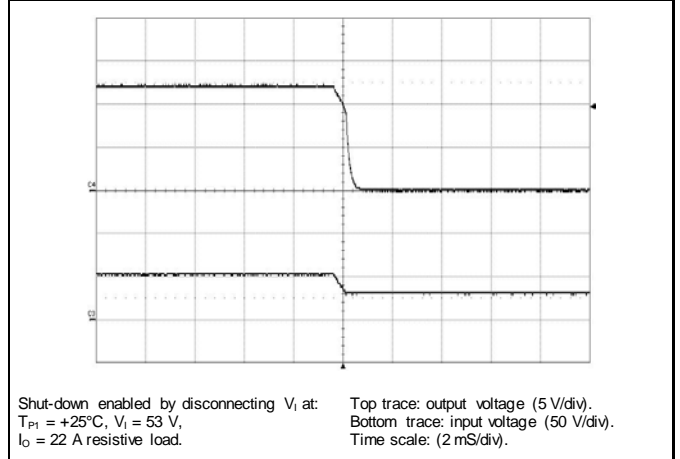

Output Ripple & Noise

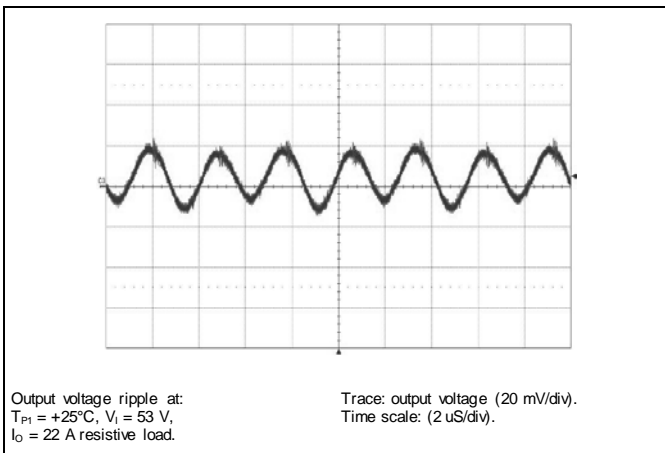

Output Load Transient Response

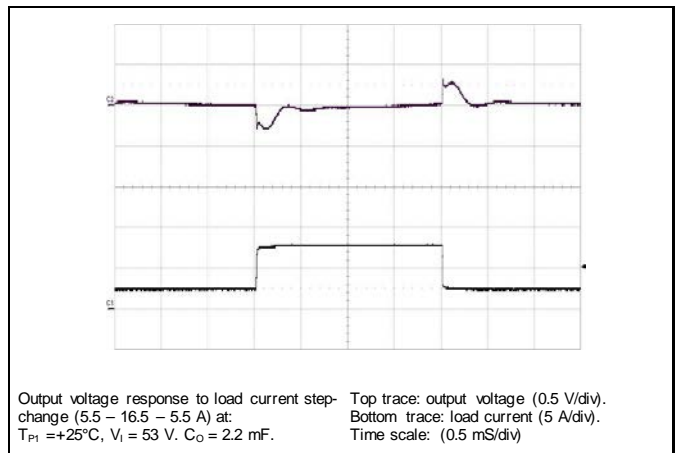

Input Voltage Transient Response

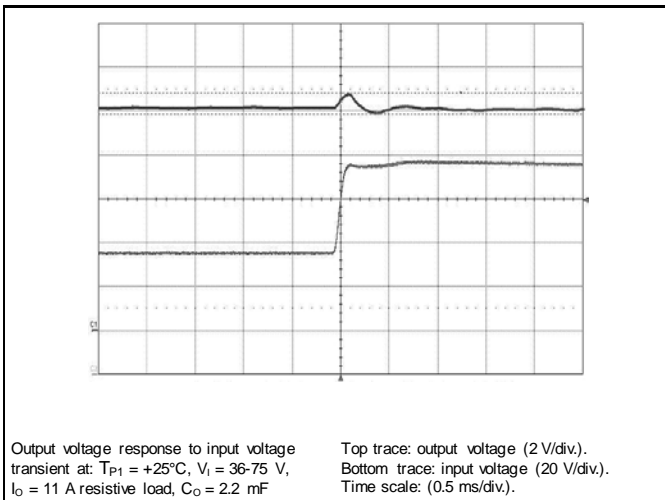

BMR457 series Fully regulated Advanced Bus Converters
 Input 36-75 V, Output up to 25 A / 300 W

1/28701-FGC 101 1835 revE September 2017

© Flex

Typical Characteristics 12 V, 22 A, 264 W

BMR 457 0004/001

Output Current Derating – Open frame

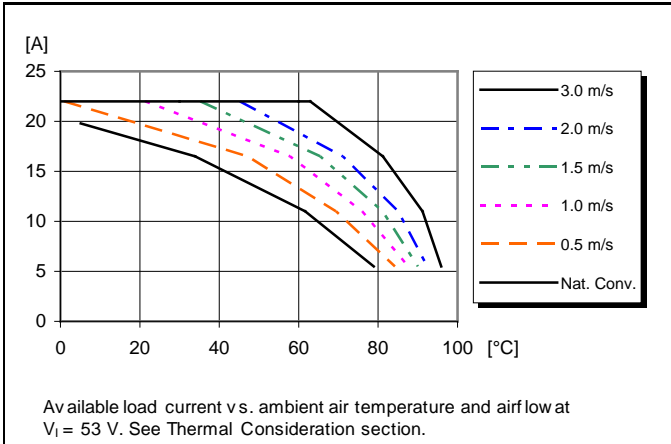

Output Current Derating – Base plate

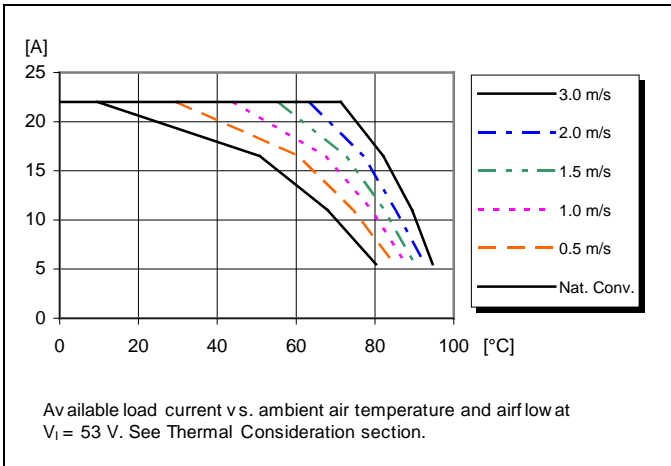

Thermal Resistance – Base plate

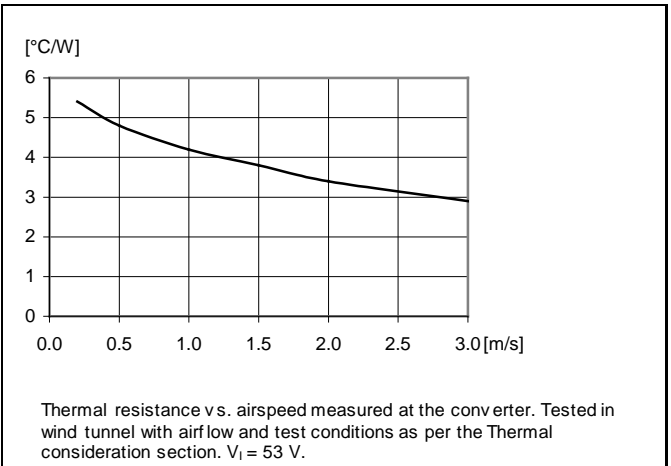

Output Current Derating – Base plate + Heat sink

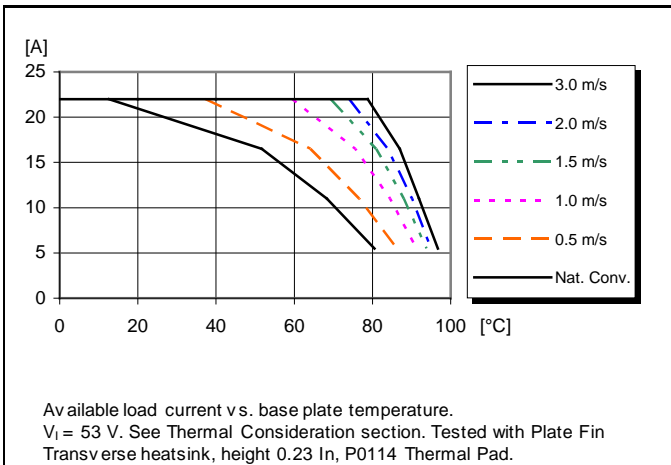

Output Current Derating – Cold wall sealed box

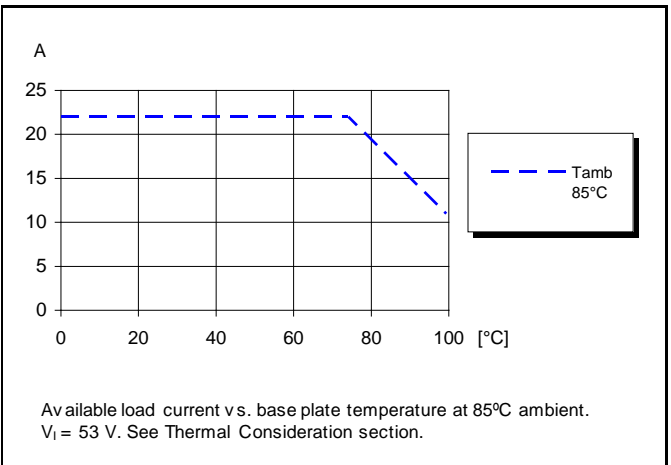

BMR457 series Fully regulated Advanced Bus Converters
 Input 36-75 V, Output up to 25 A / 300 W

1/28701-FGC 101 1835 revE September 2017
 © Flex

Electrical Specification
12 V, 25 A, 300 W

BMR457 0000/002

$T_{P1} = -40$ to $+90^{\circ}\text{C}$, $V_I = 40$ to 60 V, sense pins connected to output pins unless otherwise specified under Conditions.
 Typical values given at: $T_{P1} = +25^{\circ}\text{C}$, $V_I = 53$ V max IO, unless otherwise specified under Conditions.
 Additional $C_{in} = 0.1$ mF, $C_{out} = 0.1$ mF. See Operating Information section for selection of capacitor types.
 Configuration File: 19010-CDA1020315/002

| Characteristics | | Conditions | min | typ | max | Unit |
|-----------------|----------------------------|-----------------------------------|-----|------|-----|---------------|
| V_I | Input voltage range | | 40 | | 60 | V |
| V_{Ioff} | Turn-off input voltage | Decreasing input voltage | 36 | 37 | 38 | V |
| V_{Ion} | Turn-on input voltage | Increasing input voltage | 38 | 39 | 40 | V |
| C_I | Internal input capacitance | | | 11 | | μF |
| P_O | Output power | | 0 | | 300 | W |
| η | Efficiency | 50% of max I_O | | 95.2 | | % |
| | | max I_O | | 94.6 | | |
| | | 50% of max I_O , $V_I = 48$ V | | 95.1 | | |
| | | max I_O , $V_I = 48$ V | | 94.5 | | |
| P_d | Power Dissipation | max I_O | | 17 | 24 | W |
| P_{Ii} | Input idling power | $I_O = 0$ A, $V_I = 53$ V | | 4.4 | | W |
| P_{RC} | Input standby power | $V_I = 53$ V (turned off with RC) | | 0.4 | | W |
| f_s | Switching frequency | 0-100 % of max I_O | | 180 | | kHz |

| | | | | | | |
|-----------|---|---|-------|-----------|-------|---------------|
| V_{O1} | Output voltage initial setting and accuracy | $T_{P1} = +25^{\circ}\text{C}$, $V_I = 53$ V, $I_O = 12$ A | 11.88 | 12.00 | 12.12 | V |
| V_O | Output adjust range | See operating information | 6.9 | | 13.2 | V |
| | Output voltage tolerance band | 0-100 % of max I_O | 11.76 | | 12.24 | V |
| | Idling voltage | $I_O = 0$ A | 11.88 | | 12.12 | V |
| | Line regulation | max I_O | | 50 | 220 | mV |
| | Load regulation | $V_I = 53$ V, 1-100 % of max I_O | | 45 | 100 | mV |
| V_{tr} | Load transient voltage deviation | $V_I = 53$ V, Load step 25-75-25% of max I_O , $di/dt = 1$ A/ μs $C_{out} = 2.5$ mF OSCON type | | ± 300 | | mV |
| t_{tr} | Load transient recovery time | | | 250 | | μs |
| t_r | Ramp-up time (from 10-90% of V_{O1}) | 10-100 % of max I_O | | 8 | | ms |
| t_s | Start-up time (from V_I connection to 90% of V_{O1}) | | | 23 | | ms |
| t_f | V_I shut-down n fall time (from V_I off to 10% of V_O) | max I_O | | 0.7 | | ms |
| | | $I_O = 0$ A | | 6 | | s |
| t_{RC} | RC start-up time | max I_O | | 14 | | ms |
| | RC shut-down n fall time (from RC off to 10% of V_O) | max I_O | | 4 | | ms |
| | | $I_O = 0$ A | | 6 | | s |
| I_O | Output current | | 0 | | 25 | A |
| I_{lim} | Current limit threshold | $T_{P1} < \text{max } T_{P1}$ | 27 | 30 | 33 | A |
| I_{sc} | Short circuit current | $T_{P1} = 25^{\circ}\text{C}$, see Note 1 | | 1.1 | | A |
| C_{out} | Recommended Capacitive Load | $T_{P1} = 25^{\circ}\text{C}$, see Note 2 | 0 | 2.5 | 10 | mF |
| V_{Oac} | Output ripple & noise | See ripple & noise section, V_{O1} | | 70 | 140 | mVp-p |
| OVP | Over voltage protection | $T_{P1} = +25^{\circ}\text{C}$, $V_I = 53$ V, 10-100 % of max I_O | | 15.6 | | V |
| RC | Sink current, see Note 3 | See operating information | | | 0.7 | mA |
| | Trigger level | See operating information | | 2.6/2.9 | | V |

Note 1: OCP in hic-cup mode

Note 2: Low ESR-value

Note 3: Sink current drawn by external device connected to the RC pin. Minimum sink current required to guarantee activated RC function.

BMR457 series Fully regulated Advanced Bus Converters
 Input 36-75 V, Output up to 25 A / 300 W

1/28701-FGC 101 1835 revE September 2017

© Flex

Typical Characteristics 12 V, 25 A, 300 W

BMR 457 000 0/002

Efficiency

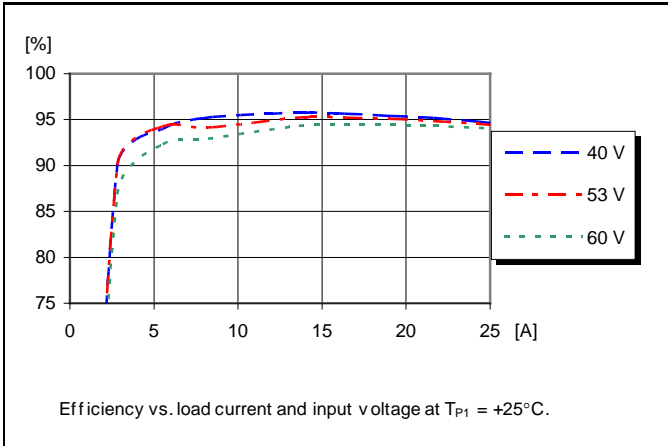

Power Dissipation

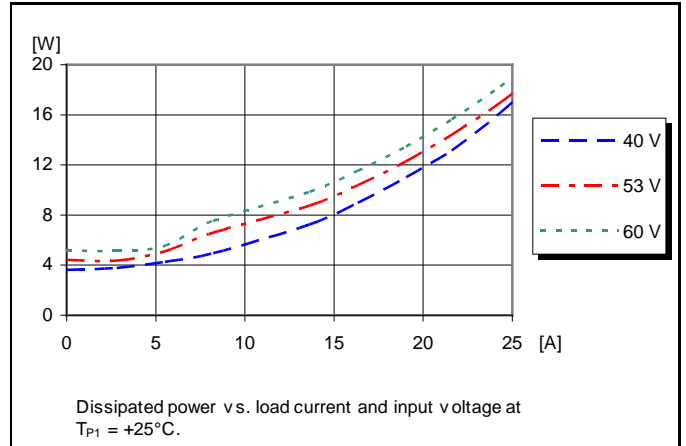

Output Characteristics

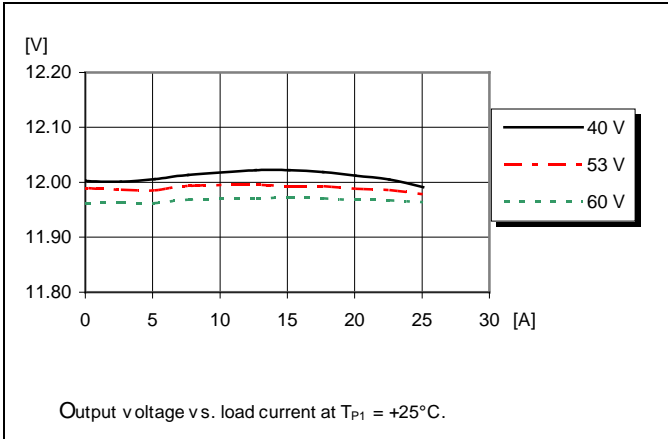

Current Limit Characteristics

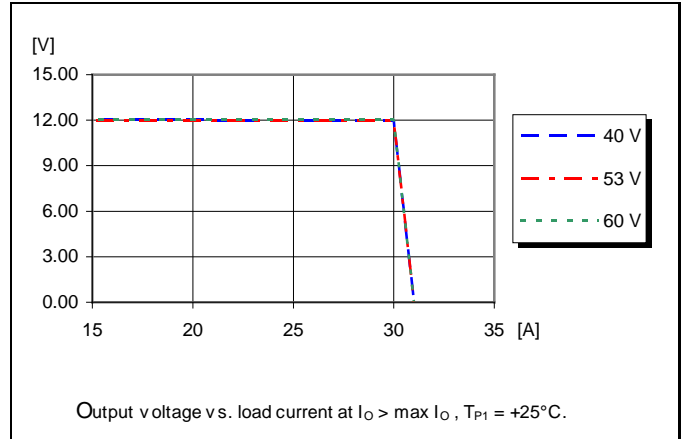

BMR457 series Fully regulated Advanced Bus Converters
 Input 36-75 V, Output up to 25 A / 300 W

1/28701-FGC 101 1835 revE September 2017

© Flex

Typical Characteristics 12 V, 25 A, 300 W

BMR 457 0000/002

Start-up

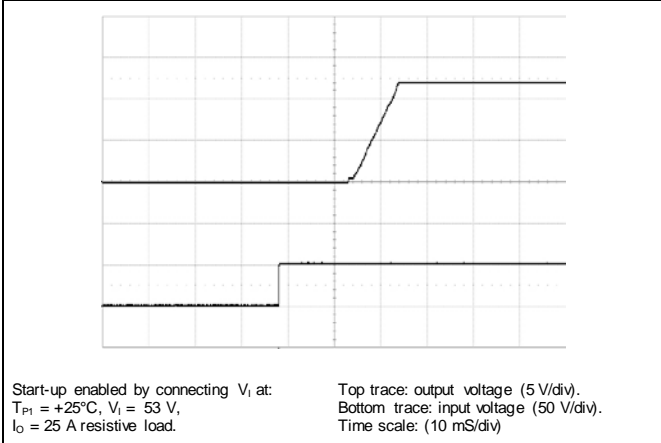

Shut-down

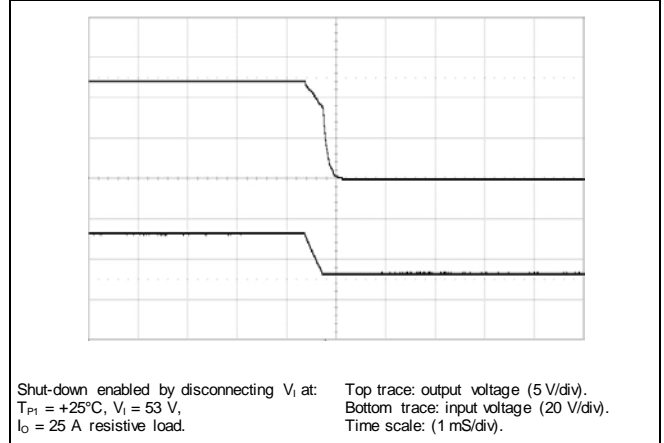

Output Ripple & Noise

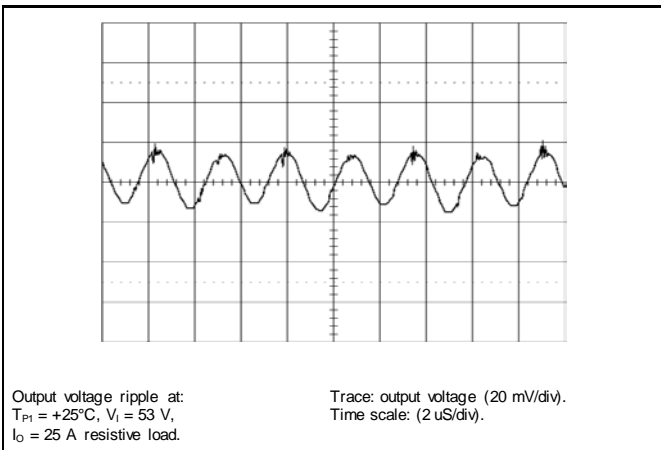

Output Load Transient Response

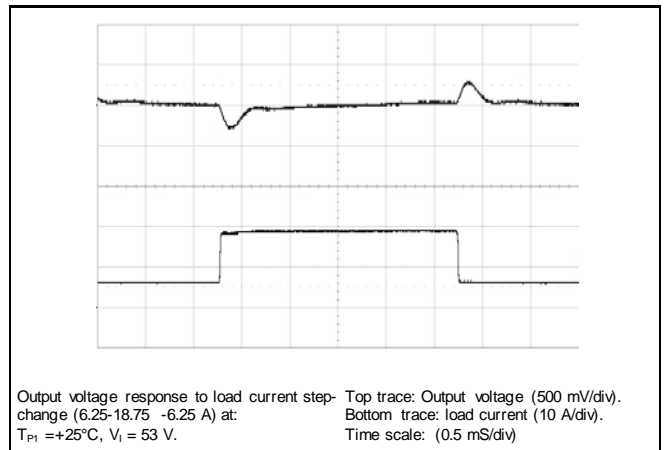

Input Voltage Transient Response

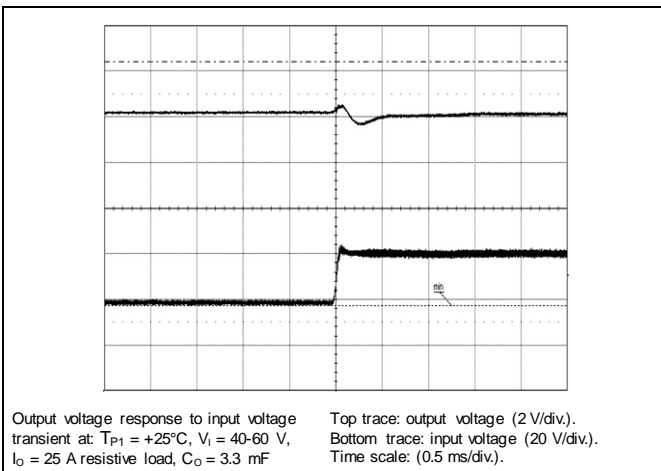

BMR457 series Fully regulated Advanced Bus Converters
 Input 36-75 V, Output up to 25 A / 300 W

1/28701-FGC 101 1835 revE September 2017

© Flex

Typical Characteristics 12 V, 25 A, 300 W

BMR 457 0000/002

Output Current Derating – Open frame

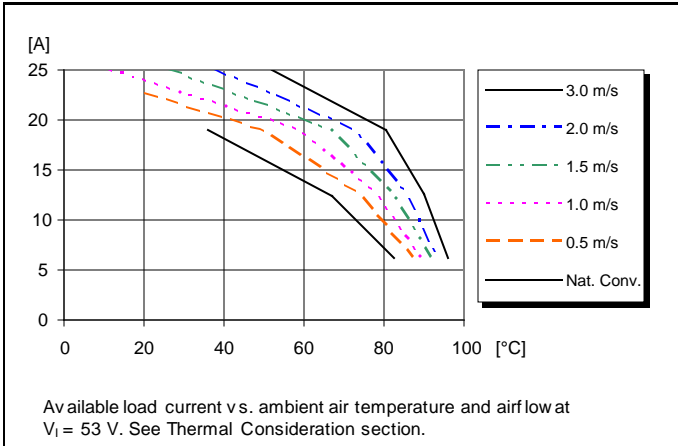

Output Current Derating – Base plate

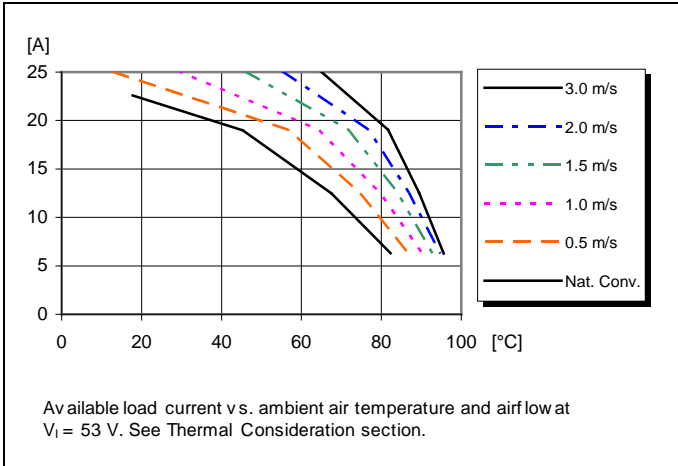

Thermal Resistance – Base plate

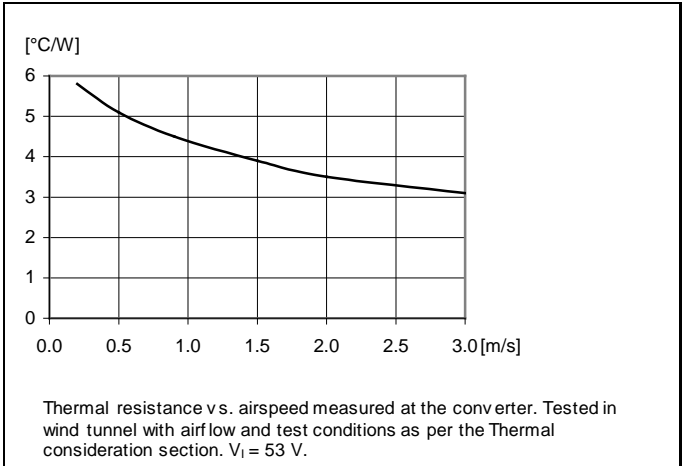

Output Current Derating – Base plate + Heat sink

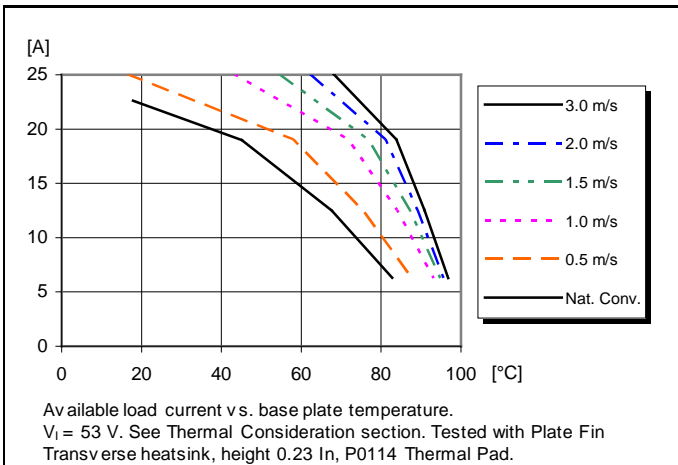

Output Current Derating – Cold wall sealed box

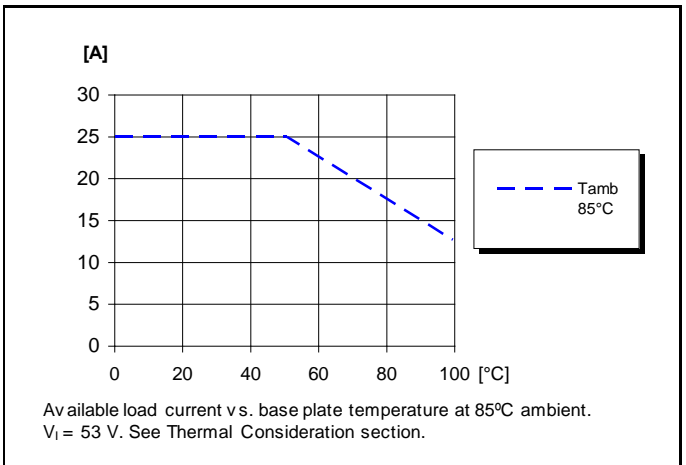

BMR457 series Fully regulated Advanced Bus Converters
 Input 36-75 V, Output up to 25 A / 300 W

1/28701-FGC 101 1835 revE September 2017

© Flex

Electrical Specification
12.45 V, 22 A, 261 W
BMR457 0007/014

$T_{P1} = -40$ to $+90^{\circ}\text{C}$, $V_I = 36$ to 75V , sense pins connected to output pins unless otherwise specified under Conditions.
 Typical values given at: $T_{P1} = +25^{\circ}\text{C}$, $V_I = 53\text{V}$, $I_O = \text{max}$, unless otherwise specified under Conditions.
 Additional $C_{in} = 0.1\text{mF}$, $C_{out} = 0.1\text{mF}$. See Operating Information section for selection of capacitor types.
 Configuration File: 19010-CDA 102 0315/014

| Characteristics | | Conditions | min | typ | max | Unit |
|-----------------|-----------------------------|---|-----|------|-----|---------------|
| V_I | Input voltage range | | 36 | | 75 | V |
| V_{loff} | Turn-off input voltage | Decreasing input voltage | 32 | 33 | 34 | V |
| V_{lon} | Turn-on input voltage | Increasing input voltage | 34 | 35 | 36 | V |
| C_I | Internal input capacitance | | | 11 | | μF |
| P_O | Output power | | 0 | | 261 | W |
| η | Efficiency | 50% of max I_O | | 94.7 | | % |
| | | max I_O | | 94.5 | | |
| | | 50% of max I_O , $V_I = 48\text{V}$ | | 95.2 | | |
| | | max I_O , $V_I = 48\text{V}$ | | 94.8 | | |
| P_d | Power Dissipation | max I_O | | 15.3 | 21 | W |
| P_{ii} | Input idling power | $I_O = 0\text{A}$, $V_I = 53\text{V}$ | | 3.5 | | W |
| P_{RC} | Input standby power | $V_I = 53\text{V}$ (turned off with RC) | | 0.4 | | W |
| f_s | Default switching frequency | 0-100% of max I_O | 171 | 180 | 189 | kHz |

| | | | | | | |
|--------------|---|---|--------|-----------|--------|---------------|
| V_{α} | Output voltage initial setting and accuracy | $T_{P1} = +25^{\circ}\text{C}$, $V_I = 53\text{V}$, $I_O = 0\text{A}$ | 12.415 | 12.45 | 12.485 | V |
| V_O | Output adjust range | See operating information | 6.9 | | 13.2 | V |
| | Output voltage tolerance band | 0-100% of max I_O | 11.5 | | 12.7 | V |
| | Line regulation | max I_O | | 100 | 250 | mV |
| | Load regulation | $V_I = 53\text{V}$, 1-100% of max I_O | 450 | 600 | 700 | mV |
| V_{tr} | Load transient voltage deviation | $V_I = 53\text{V}$, Load step 25-75-25% of max I_O , $di/dt = 1\text{A}/\mu\text{s}$, $C_{out} = 2.2\text{mF}$ OSCON type | | ± 350 | | mV |
| t_{tr} | Load transient recovery time | | | 200 | | μs |
| t_r | Ramp-up time (from 10-90% of V_O) | 10-100% of max I_O | | 23 | | ms |
| t_s | Start-up time (from V_I connection to 90% of V_O) | | | 38 | | ms |
| t_f | V_I shut-down fall time (from V_I off to 10% of V_O) | max I_O | | 0.7 | | ms |
| | | $I_O = 0\text{A}$ | | 6 | | s |
| t_{RC} | RC start-up time | max I_O | | 26 | | ms |
| | RC shut-down fall time (from RC off to 10% of V_O) | max I_O | | 3.5 | | ms |
| | | $I_O = 0\text{A}$ | | 6 | | s |
| I_O | Output current | | 0 | | 22 | A |
| I_{lim} | Current limit threshold | $V_O = 10.8\text{V}$, $T_{P1} < \text{max } T_{P1}$ | 24 | 25 | 26 | A |
| I_{sc} | Short circuit current | $T_{P1} = 25^{\circ}\text{C}$, see Note 1 | | 7 | | A |
| C_{out} | Recommended Capacitive Load | $T_{P1} = 25^{\circ}\text{C}$, see Note 2 | 0 | 2.2 | 6 | mF |
| V_{Oac} | Output ripple & noise | See ripple & noise section, V_O | | 50 | 150 | mVp-p |
| OVP | Over voltage protection | $T_{P1} = +25^{\circ}\text{C}$, $V_I = 53\text{V}$, 10-100% of max I_O | | 15.6 | | V |
| RC | Sink current, see Note 3 | See operating information | | | 0.7 | mA |
| | Trigger level | Decreasing / Increasing RC-voltage | | 2.6/2.9 | | V |

Note 1: OCP in hic-up mode

Note 2: Low ESR-value

Note 3: Sink current drawn by external device connected to the RC pin. Minimum sink current required to guarantee activated RC function.

BMR457 series Fully regulated Advanced Bus Converters
 Input 36-75 V, Output up to 25 A / 300 W

1/28701-FGC 101 1835 revE September 2017

© Flex

Typical Characteristics
 12.45 V, 40 A / 476 W, two products in parallel

2 × BMR 457 0007/014

Efficiency

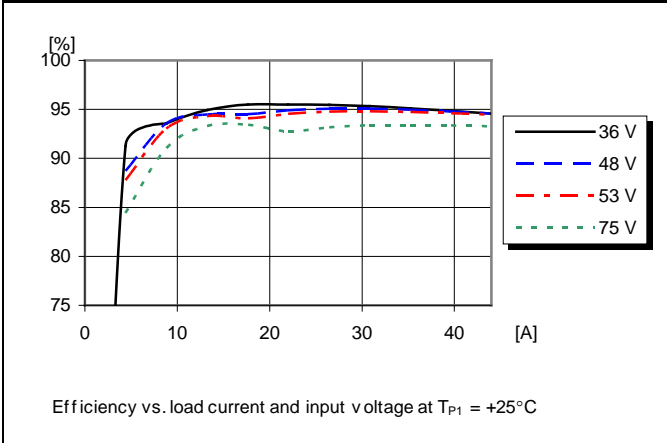

Power Dissipation

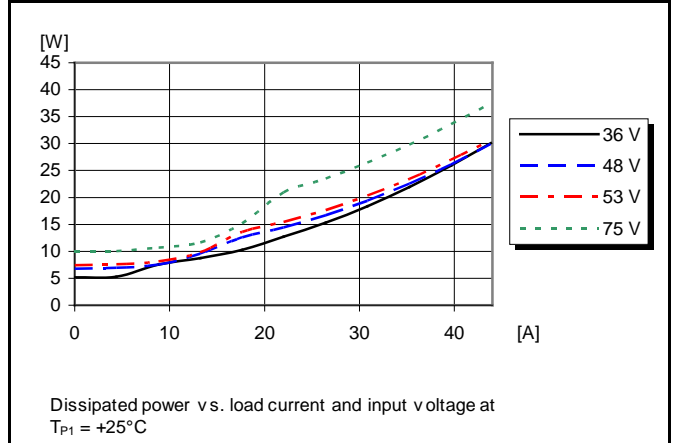

Output Characteristics

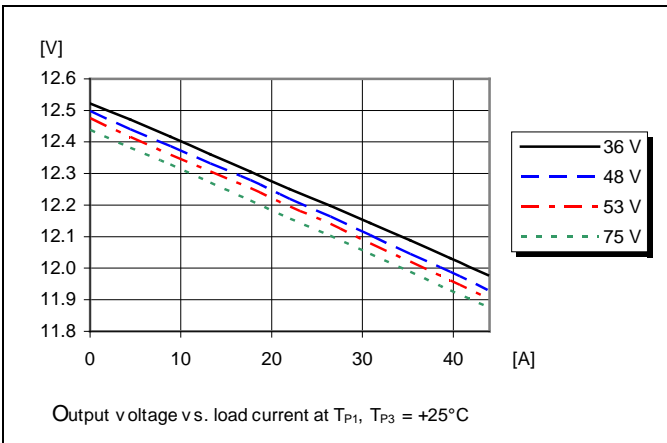

Current Limit Characteristics

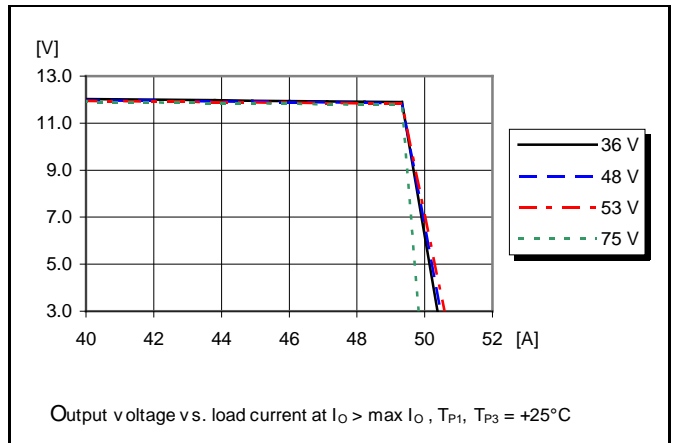

Start-up

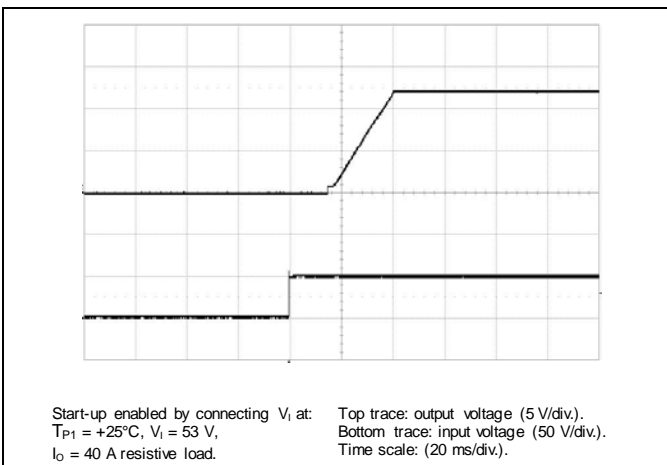

Output Load Transient Response

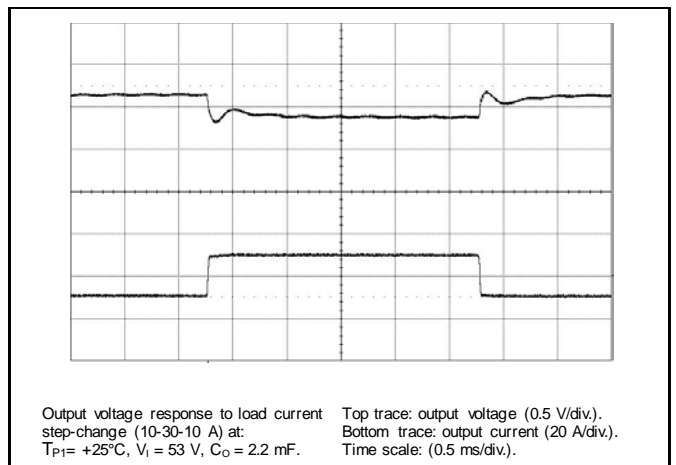

BMR457 series Fully regulated Advanced Bus Converters
 Input 36-75 V, Output up to 25 A / 300 W

1/28701-FGC 101 1835 revE September 2017

© Flex

Typical Characteristics 12.45 V, 22 A, 261 W

BMR 457 0007/014

Output Current Derating – Open frame

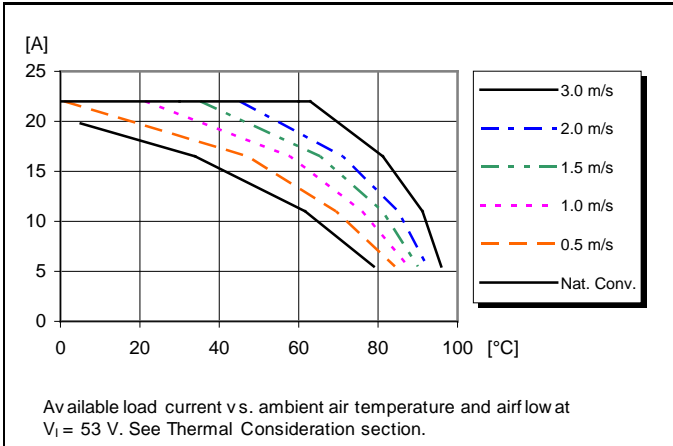

Output Current Derating – Base plate

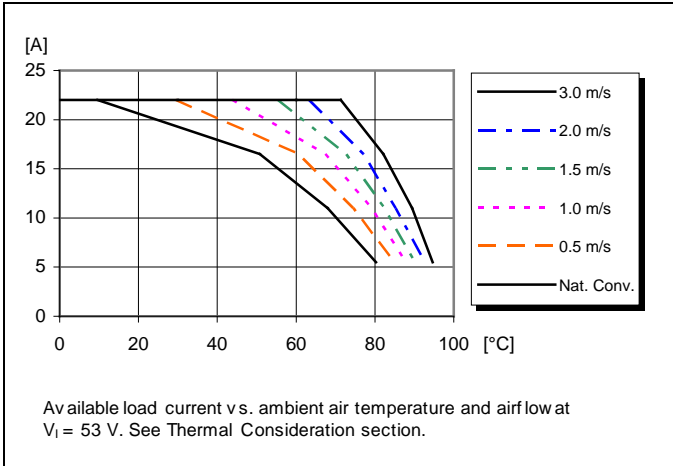

Thermal Resistance – Base plate

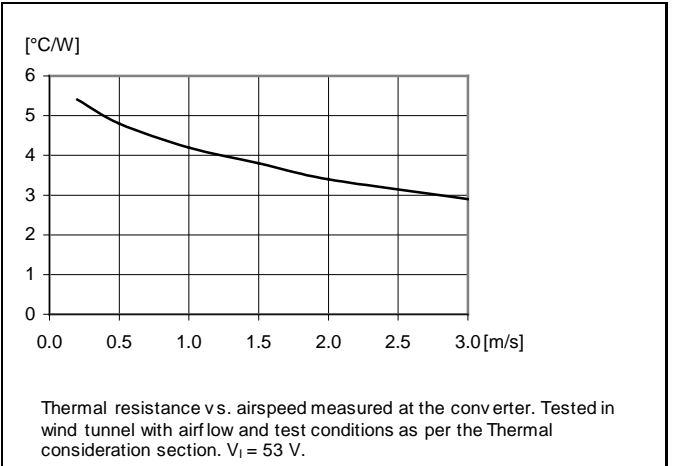

Output Current Derating – Base plate + Heat sink

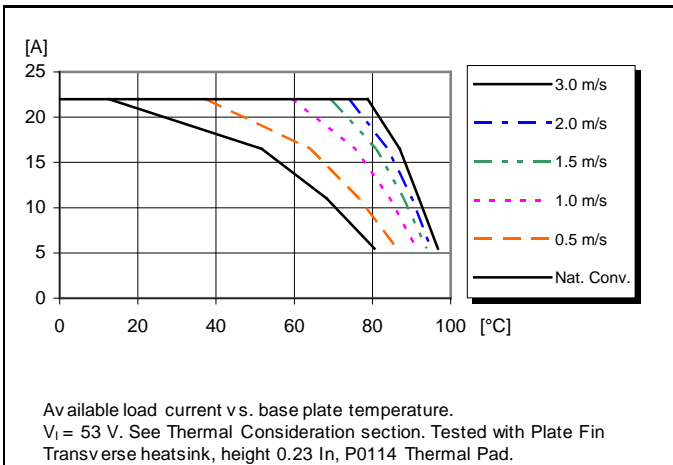

Output Current Derating – Cold wall sealed box

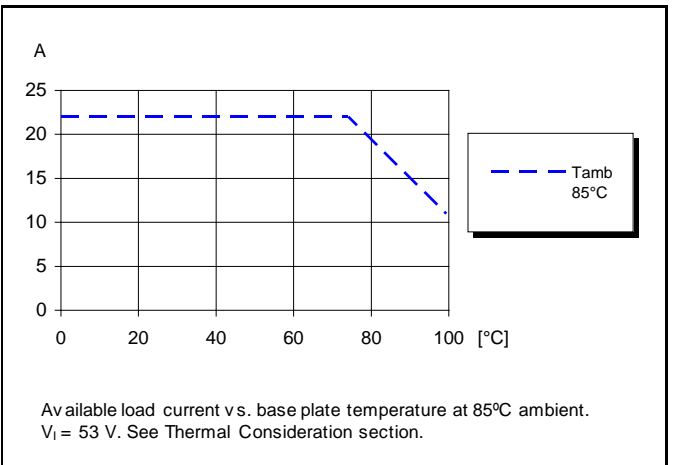

BMR457 series Fully regulated Advanced Bus Converters
 Input 36-75 V, Output up to 25 A / 300 W

1/28701-FGC 101 1835 revE September 2017

© Flex

Electrical Specification
12.45 V, 25 A, 296 W
BMR457 0011/017

$T_{P1} = -40$ to $+90^{\circ}\text{C}$, $V_I = 40$ to 60 V, sense pins connected to output pins unless otherwise specified under conditions.
 Typical values given at: $T_{P1} = +25^{\circ}\text{C}$, $V_I = 53$ V, $\max I_o$, unless otherwise specified under conditions.
 Additional $C_{in} = 0.1$ mF, $C_{out} = 0.1$ mF. See Operating Information section for selection of capacitor types.
 Configuration File: 19010-CDA1020315/017

| Characteristics | | Conditions | min | typ | max | Unit |
|-----------------|----------------------------|-----------------------------------|-----|------|-----|---------------|
| V_I | Input voltage range | | 40 | | 60 | V |
| V_{Ioff} | Turn-off input voltage | Decreasing input voltage | 36 | 37 | 38 | V |
| V_{Ion} | Turn-on input voltage | Increasing input voltage | 38 | 39 | 40 | V |
| C_I | Internal input capacitance | | | 11 | | μF |
| P_o | Output power | | 0 | | 296 | W |
| η | Efficiency | 50% of $\max I_o$ | | 95.2 | | % |
| | | $\max I_o$ | | 94.6 | | |
| | | 50% of $\max I_o$, $V_I = 48$ V | | 95.1 | | |
| | | $\max I_o$, $V_I = 48$ V | | 94.5 | | |
| P_d | Power Dissipation | $\max I_o$ | | 17 | 24 | W |
| P_{Ii} | Input idling power | $I_o = 0$ A, $V_I = 53$ V | | 4.4 | | W |
| P_{RC} | Input standby power | $V_I = 53$ V (turned off with RC) | | 0.4 | | W |
| f_s | Switching frequency | 0-100 % of $\max I_o$ | | 180 | | kHz |

| | | | | | | |
|-----------|---|--|--------|-----------|--------|---------------|
| V_{O1} | Output voltage initial setting and accuracy | $T_{P1} = +25^{\circ}\text{C}$, $V_I = 53$ V, $I_o = 0$ A | 12.415 | 12.45 | 12.485 | V |
| V_o | Output adjust range | See operating information | 6.9 | | 13.2 | V |
| | Output voltage tolerance band | 0-100 % of $\max I_o$ | 11.5 | | 12.7 | V |
| | Line regulation | $\max I_o$ | | 50 | 220 | mV |
| | Load regulation | $V_I = 53$ V, 1-100 % of $\max I_o$ | 400 | 500 | 700 | mV |
| V_{tr} | Load transient voltage deviation | $V_I = 53$ V, Load step 25-75-25% of $\max I_o$, $di/dt = 1$ A/ μs $C_{out} = 2.5$ mF OSCON type | | ± 300 | | mV (AC) |
| t_{tr} | Load transient recovery time | | | 250 | | μs |
| t_r | Ramp-up time (from 10-90% of V_{O1}) | 10-100 % of $\max I_o$ | | 23 | | ms |
| t_s | Start-up time (from V_I connection to 90% of V_{O1}) | | | 38 | | ms |
| t_f | V_I shut-down n fall time (from V_I off to 10% of V_o) | $\max I_o$ | | 0.7 | | ms |
| | | $I_o = 0$ A | | 6 | | s |
| t_{RC} | RC start-up time | $\max I_o$ | | 14 | | ms |
| | RC shut-down n fall time (from RC off to 10% of V_o) | $\max I_o$ | | 4 | | ms |
| | | $I_o = 0$ A | | 6 | | s |
| I_o | Output current | | 0 | | 25 | A |
| I_{lim} | Current limit threshold | $T_{P1} < \max T_{P1}$ | 27 | 30 | 33 | A |
| I_{sc} | Short circuit current | $T_{P1} = 25^{\circ}\text{C}$, see Note 1 | | 11 | | A |
| C_{out} | Recommended Capacitive Load | $T_{P1} = 25^{\circ}\text{C}$, see Note 2 | 0 | 2.5 | 10 | mF |
| V_{Oac} | Output ripple & noise | See ripple & noise section, V_{O1} | | 70 | 140 | mVp-p |
| OVP | Over voltage protection | $T_{P1} = +25^{\circ}\text{C}$, $V_I = 53$ V, 10-100 % of $\max I_o$ | | 15.6 | | V |
| RC | Sink current, see Note 3 | See operating information | | | 0.7 | mA |
| | Trigger level | See operating information | | 2.6/2.9 | | V |

Note 1: OCP in hic-cup mode, rms value were recorded.

Note 2: Low ESR-value

Note 3: Sink current drawn by external device connected to the RC pin. Minimum sink current required to guarantee activated RC function.

BMR457 series Fully regulated Advanced Bus Converters
 Input 36-75 V, Output up to 25 A / 300 W

1/28701-FGC 101 1835 revE September 2017

© Flex

Typical Characteristics
12.45 V, 45 A, 533 W, 2 products in parallel

2 × BMR 457 0011/017

Efficiency

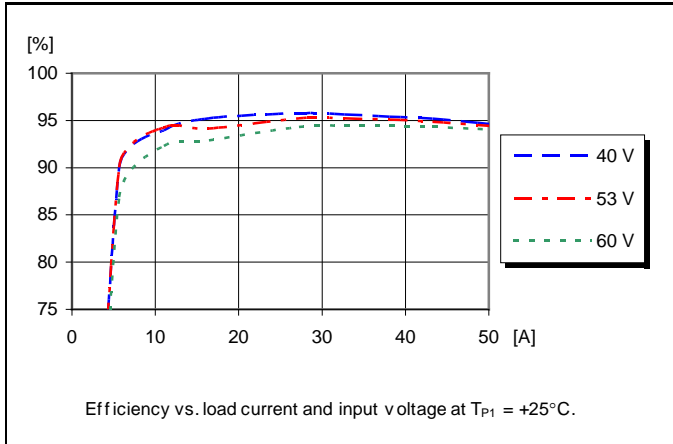

Power Dissipation

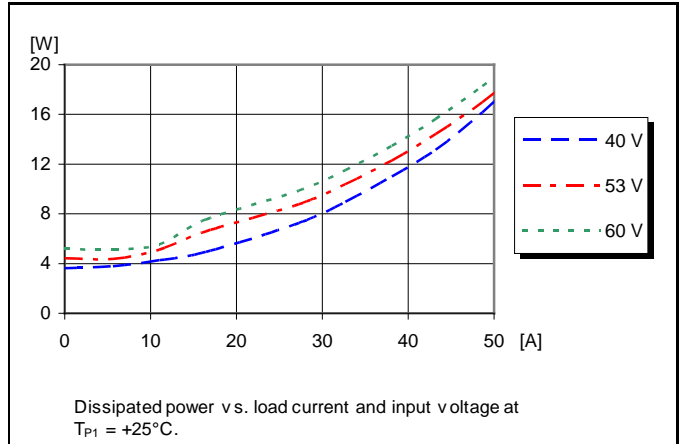

Output Characteristics

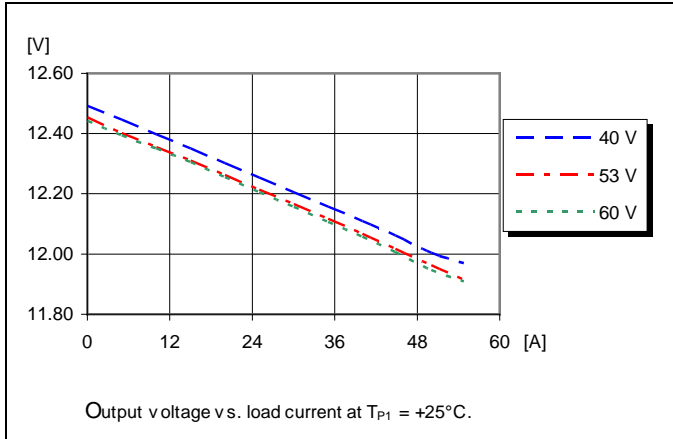

Current Limit Characteristics

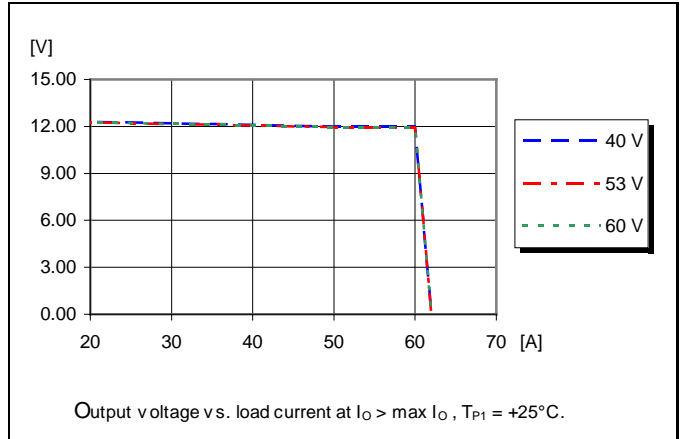

Start-up

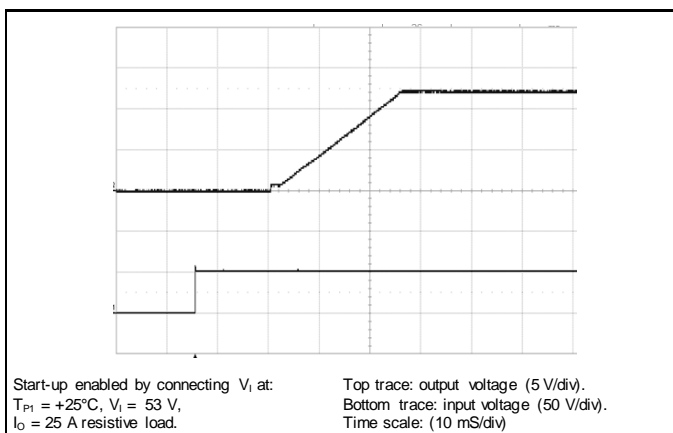

Output Load Transient Response

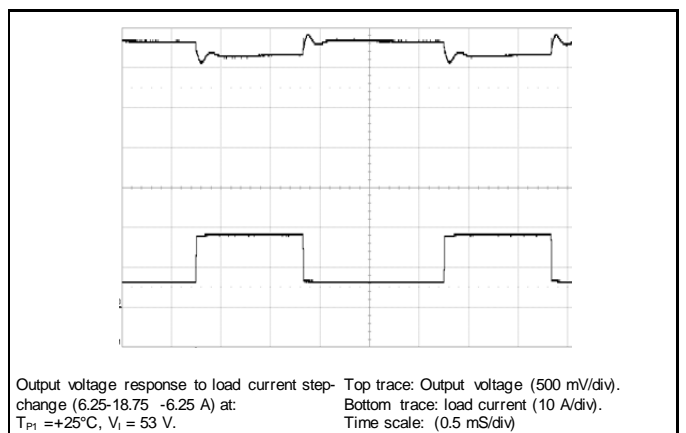

BMR457 series Fully regulated Advanced Bus Converters
 Input 36-75 V, Output up to 25 A / 300 W

1/28701-FGC 101 1835 revE September 2017

© Flex

Typical Characteristics 12.45 V, 25 A, 296 W

BMR 457 0011/017

Output Current Derating – Open frame

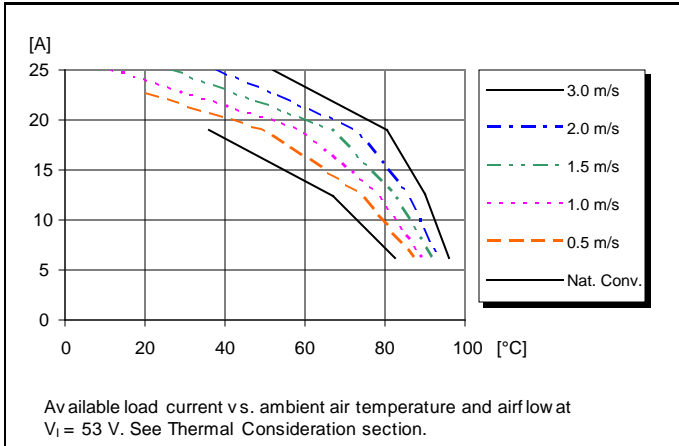

Output Current Derating – Base plate

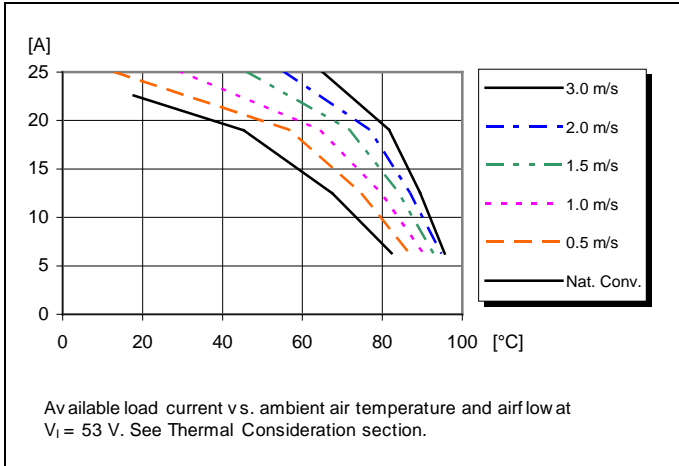

Thermal Resistance – Base plate

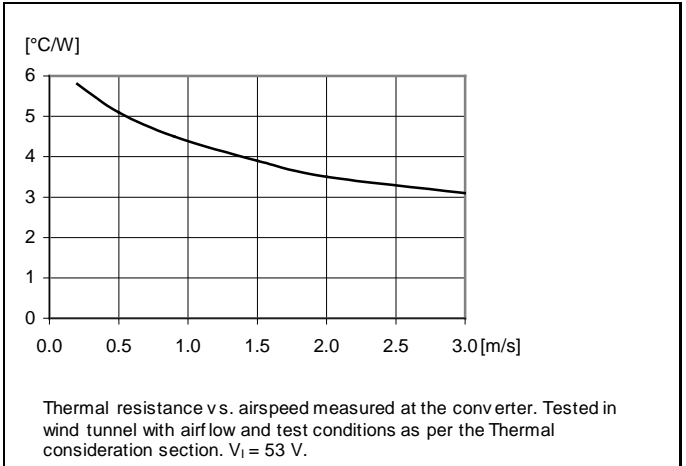

Output Current Derating – Base plate + Heat sink

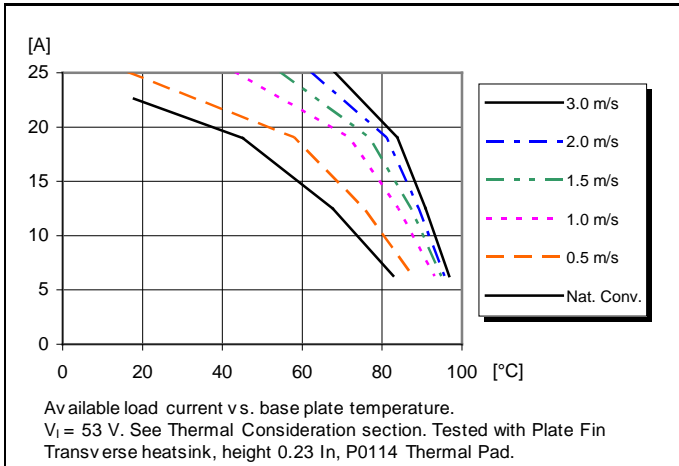

Output Current Derating – Cold wall sealed box

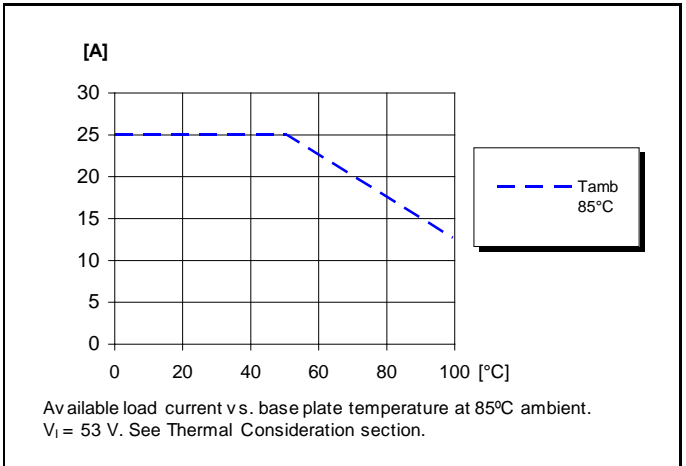

BMR457 series Fully regulated Advanced Bus Converters
 Input 36-75 V, Output up to 25 A / 300 W

1/28701-FGC 101 1835 revE September 2017

© Flex

EMC Specification

Conducted EMI measured according to EN55022, CISPR 22 and FCC part 15J (see test set-up). See Design Note 009 for detailed information. The fundamental switching frequency is 180 kHz for BMR 457 at $V_I = 53$ V, max I_O .

Conducted EMI Input terminal value (typ)

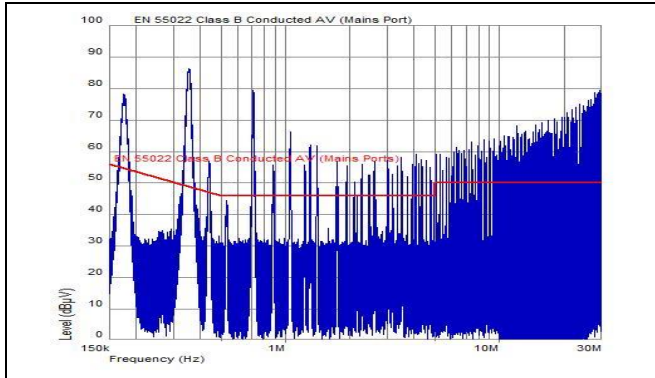

EMI without filter

Optional external filter for class B

Suggested external input filter in order to meet class B in EN 55022, CISPR 22 and FCC part 15J.

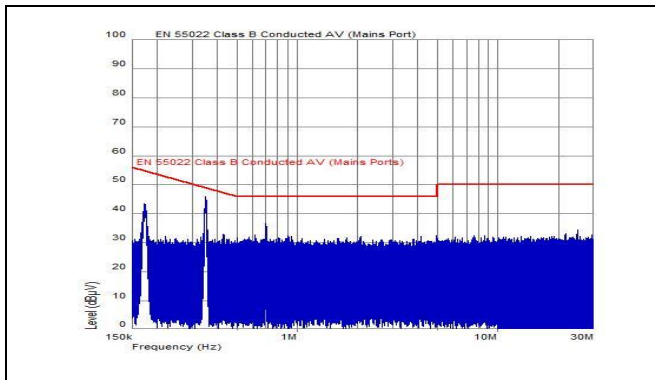
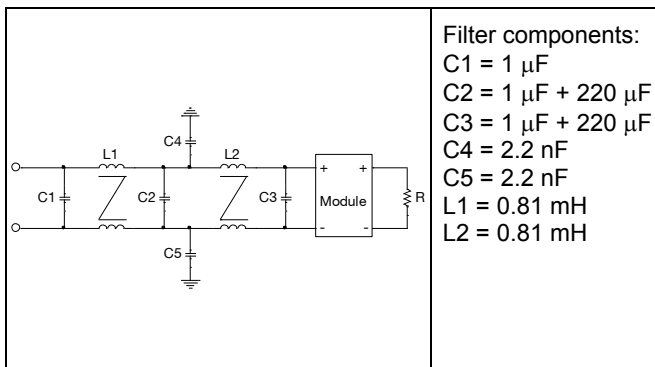

EMI with filter

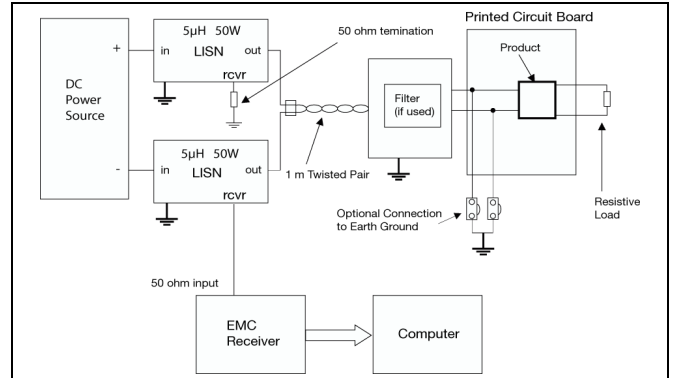

Test set-up

Layout recommendations

The radiated EMI performance of the product will depend on the PWB layout and ground layer design. It is also important to consider the stand-off of the product. If a ground layer is used, it should be connected to the output of the product and the equipment ground or chassis.

A ground layer will increase the stray capacitance in the PWB and improve the high frequency EMC performance.

Output ripple and noise

Output ripple and noise measured according to figure below. See Design Note 022 for detailed information.

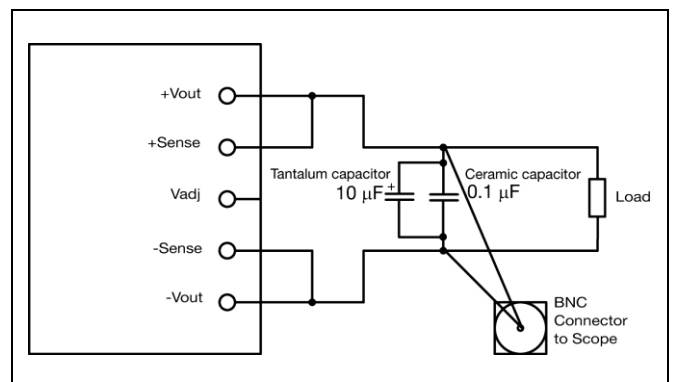

Output ripple and noise test setup

BMR457 series Fully regulated Advanced Bus Converters
Input 36-75 V, Output up to 25 A / 300 W

1/28701-FGC 101 1835 revE September 2017

© Flex

Operating information

Power Management Overview

This product is equipped with a PMBus interface to allow the product to be configured, and communicate with system controllers. The product incorporates a wide range of readable and configurable power management features that are simple to implement with a minimum of external components. Additionally, the product includes protection features that continuously safeguard the load from damage due to unexpected system faults. A fault is also shown as an alert on the SALERT pin. The following product parameters can continuously be monitored by a host: Input voltage, output voltage/current, duty cycle and internal temperature.

The product is delivered with a default configuration suitable for a wide range operation in terms of input voltage, output voltage, and load. The configuration is stored in an internal Non-Volatile Memory (NVM). All power management functions can be reconfigured using the PMBus interface. Please contact your local Flex Power Modules representative for design support of custom configurations or appropriate SW tools for design and down-load of your own configurations.

Input Voltage

The BMR457 consists of two different product families designed for two different input voltage ranges, 36 to 75 Vdc and 40 to 60 Vdc, see ordering information.

The input voltage range 36 to 75 Vdc meets the requirements of the European Telecom Standard ETS 300 132-2 for normal input voltage range in -48 and -60 Vdc systems, -40.5 to -57.0 V and -50.0 to -72 V respectively.

At input voltages exceeding 75 V, the power loss will be higher than at normal input voltage and T_{P1} must be limited to absolute max +125°C. The absolute maximum continuous input voltage is 80 Vdc.

The input voltage range 40 to 60 Vdc meets the requirements for normal input voltage range in -48 V systems, -40.5 to -57.0 V. At input voltages exceeding 60 V, the power loss will be higher than at normal input voltage and T_{P1} must be limited to absolute max +125°C. The absolute maximum continuous input voltage is 65 Vdc.

Turn-off Input Voltage

The product monitors the input voltage and will turn on and turn off at predetermined levels. The minimum hysteresis between turn on and turn off input voltage is 2 V. The turn on and turn off levels of the product can be reconfigured using the PMBus interface

Remote Control (RC)

The products are fitted with a configurable remote control function. The primary remote control is referenced to the primary negative input connection (-In). The RC function allows the converter to be turned on/off by an external device

like a semiconductor or mechanical switch. The RC pin has an internal pull up resistor. The remote control functions can also be configured using the PMBus

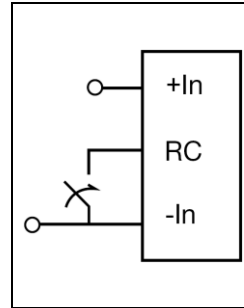

The device should be capable of sinking 0.7 mA. When the RC pin is left open, the voltage generated on the RC pin is max 6 V. The standard product is provided with “negative logic” remote control and will be off until the RC pin is connected to the -In. To turn on the product the voltage between RC pin and -In should be less than 1 V.

To turn off the product the RC pin should be left open for a minimum of time 150 μ s, the same time requirement applies when the product shall turn on. In situations where it is desired to have the product to power up automatically without the need for control signals or a switch, the RC pin can be wired directly to -In or disabled via the 0xE3 command. The logic option for the primary remote control is configured via 0xE3 command using the PMBus.

Remote Control (secondary side)

The CTRL-pin can be configured as remote control via the PMBus interface. In the default configuration the CTRL-pin is disabled and floating. The output can be configured to internal pull-up to 3.3 V using the MFR_MULTI_PIN_CONFIG (0xF9) PMBus command. The CTRL-pin can be left open when not used. The logic options for the secondary remote control can be positive or negative logic. The logic option for the secondary remote control is configured via ON_OFF_CONFIG (0x02) command using the PMBus interface, see also MFR_MULTI_PIN_CONFIG section.

Input and Output Impedance

The impedance of both the input source and the load will interact with the impedance of the product. It is important that the input source has low characteristic impedance. Minimum recommended external input capacitance is 100 μ F. The performance in some applications can be enhanced by addition of external capacitance as described under External Decoupling Capacitors.

External Decoupling Capacitors

When powering loads with significant dynamic current requirements, the voltage regulation at the point of load can be improved by addition of decoupling capacitors at the load. The recommended minimum capacitance on the output is 100 μ F. The most effective technique is to locate low ESR ceramic and electrolytic capacitors as close to the load as possible, using several parallel capacitors to lower the effective ESR. The ceramic capacitors will handle high-frequency dynamic load changes while the electrolytic capacitors are used to handle low frequency dynamic load changes. Ceramic capacitors will also reduce any high frequency noise at the

BMR457 series Fully regulated Advanced Bus Converters Input 36-75 V, Output up to 25 A / 300 W

1/28701-FGC 101 1835 revE September 2017

© Flex

load. It is equally important to use low resistance and low inductance PWB layouts and cabling. External decoupling capacitors will become part of the product's control loop. The control loop is optimized for a wide range of external capacitance and the maximum recommended value that could be used without any additional analysis is found in the electrical specification.

The ESR of the capacitors is a very important parameter. Stable operation is guaranteed with a verified ESR value of >10 m Ω across the output connections.

For further information please contact your local Flex Power Modules representative.

Parallel Operation (Droop Load Share, DLS)

The BMR457 DLS products are variants that can be connected in parallel. The products have a pre-configured voltage droop: The stated output voltage set point is at no load. The output voltage will decrease when the load current is increased. The voltage will droop 0.6 V while load reaches max load. This feature allows the products to be connected in parallel and share the current with 10% accuracy. Up to 90% of max output current can be used from each product.

When running DLS-products in parallel command (0xF9) must be set according to MFR_MULTI_PIN_CONFIG. To prevent unnecessary current stress, changes of the output voltage must be done with the output disabled. This must be considered for all commands that affect the output voltage.

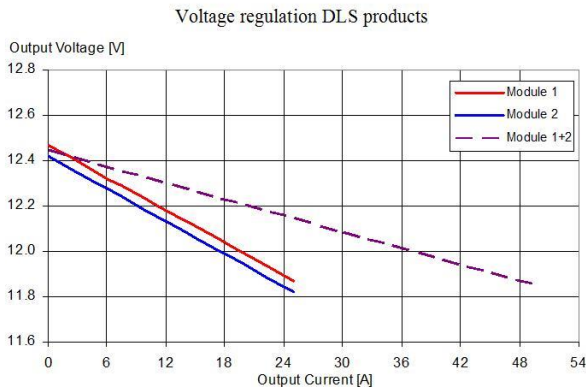

Feed Forward Capability

The BMR457 products have a feed forward function implemented that can handle sudden input voltage changes. The output voltage will be regulated during an input transient and will typically stay within 10% when an input transient is applied.

PMBus configuration and support

The product provides a PMBus digital interface that enables the user to configure many aspects of the device operation as well as monitor the input and output parameters.

Please contact your local Flex Power Modules representative for appropriate SW tools to down-load new configurations.

Output Voltage Adjust using PMBus

The output voltage of the product can be reconfigured using the PMBus interface.

Margin Up/Down Controls

These controls allow the output voltage to be momentarily adjusted, either up or down, by a nominal 10%. This provides a convenient method for dynamically testing the operation of the load circuit over its supply margin or range. It can also be used to verify the function of supply voltage supervisors. The margin up and down levels of the product can be re-configured using the PMBus interface.

Soft-start Power Up

The default rise time of the ramp up is 10 ms. When starting by applying input voltage the control circuit boot-up time adds an additional 15 ms delay. The soft-start power up of the product can be reconfigured using the PMBus interface. The DLS variants have a pre-configured ramp up time of 25 ms.

Remote Sense

The product has remote sense that can be used to compensate for voltage drops between the output and the point of load. The sense traces should be located close to the PWB ground layer to reduce noise susceptibility. The remote sense circuitry will compensate for up to 10% voltage drop between output pins and the point of load. If the remote sense is not needed +Sense should be connected to +Out and -Sense should be connected to -Out. To be able to use remote sense the converter must be equipped with a Communication interface.

Temperature Protection (OTP, UTP)

The products are protected from thermal overload by an internal temperature shutdown protection.

When T_{P1} as defined in thermal consideration section is exceeded the product will shut down. The product will make continuous attempts to start up (non-latching mode) and resume normal operation automatically when the temperature has dropped below the temperature threshold set in the command OT_WARN_LIMIT (0x51); the hysteresis is defined in general electrical specification.

The OTP and hysteresis of the product can be re-configured using the PMBus interface. The product has also an under temperature protection. The OTP and UTP fault limit and fault response can be configured via the PMBus. Note: using the fault response "continue without interruption" may cause permanent damage to the product

Over Voltage Protection (OVP)

The product includes over voltage limiting circuitry for protection of the load. The default OVP limit is 30% above the nominal output voltage. If the output voltage exceeds the OVP limit, the product can respond in different ways.

BMR457 series Fully regulated Advanced Bus Converters
Input 36-75 V, Output up to 25 A / 300 W

1/28701-FGC 101 1835 revE September 2017
© Flex

The default response from an over voltage fault is to immediately shut down. The device will continuously check for the presence of the fault condition, and when the fault condition no longer exists the device will be re-enabled. The OVP fault level and fault response can be re-configured using the PMBus interface.

Over Current Protection (OCP)

The product includes current limiting circuitry for protection at continuous overload. The default setting for the product is hic-up mode if the maximum output current is exceeded and the output voltage is below $0.3 \times V_{out}$, set in command IOUT_OC_LV_FAULT_LIMIT (0x48). Above the trip voltage value in command 0x48 the product will continue operate while maintaining the output current at the value set by IOUT_OC_FAULT_LIMIT (0x46). The load distribution should be designed for the maximum output short circuit current specified.

Droop Load Share variants (DLS) will enter hic-up mode, with a trip voltage, $0.04 \times V_{out}$, set in command IOUT_OC_LV_FAULT_LIMIT (0x48). Above the trip voltage in command (0x48) the product will continue operate while maintaining the output current at the value set by IOUT_OC_FAULT_LIMIT (0x46).

The over current protection of the product can be reconfigured using the PMBus interface.

Input Over/Under voltage protection

The input of the product can be protected from high input voltage and low input voltage. The over/under-voltage fault level and fault response can be configured via the PMBus interface.

Pre-bias Start-up Capability

The product has a Pre-bias start up functionality and will not sink current during start up if a Pre-bias source is present at the output terminals. If the Pre-bias voltage is lower than the target value set in VOUT_COMMAND (0x21), the product will ramp up to the target value. If the Pre-bias voltage is higher than the target value set in VOUT_COMMAND (0x21), the product will ramp down to the target value and in this case sink current for a limited of time set in the command TOFF_MAX_WARN_LIMIT (0x66).

Power Good

The product provides Power Good (PG) flag in the Status Word register that indicates the output voltage is within a specified tolerance of its target level and no fault condition exists. If specified in section Connections, the product also provides a PG signal output. The Power Good signal is by default configured as active low, Push-pull and can be re-configured via the PMBus interface. The Power Good output can be configured as Push-pull or “High Z when active” to permit AND’ing of parallel devices. It is not recommended to use Push-pull when paralleling PG-pins, see

MFR_MULTI_PIN_CONFIG.

Synchronization, Tracking and External reference

This product does not support synchronization, tracking or external reference.

Switching frequency adjust using PMBus

The switching frequency is set to 180 kHz as default but this can be reconfigured via the PMBus interface. The product is optimized at this frequency but can run at lower and higher frequency, (170 kHz – 190 kHz). The electrical performance can be affected if the switching frequency is changed.

MFR_MULTI_PIN_CONFIG

The MFR_MULTI_PIN_CONFIG (0xF9) command enables or disables different functions inside the product. This command can be configured according to the table for different functions.

| | | | | | | | | | | | | |
|---|---------------------------|------------------------------------|---|---|--|--|-----------------------------------|--|---|---|--|--|
| Bit 7:6 00 = Stand alone 01 = Slave (N/A) 10 = DLS 11 = Master (N/A) | 1 | 1 | 1 | 1 | 1 | 1 | 0 | 0 | 0 | 0 | 0 | 0 |
| Bit 5 Power Good High Z when active | 0 | 0 | 0 | 0 | 1 | 1 | 0 | 0 | 0 | 0 | 1 | 1 |
| Bit 4 Tracking enable (N/A) | 0 | 0 | 0 | 0 | 0 | 0 | 0 | 0 | 0 | 0 | 0 | 0 |
| Bit 3 External reference (N/A) | 0 | 0 | 0 | 0 | 0 | 0 | 0 | 0 | 0 | 0 | 0 | 0 |
| Bit 2 Power Good Enable | 0 | 0 | 1 | 1 | 1 | 1 | 0 | 0 | 1 | 1 | 1 | 1 |
| Bit 1 Reserved | 1 | 1 | 1 | 1 | 1 | 1 | 0 | 0 | 0 | 0 | 0 | 0 |
| Bit 0 Secondary Remote Control Pull up/down resistor enable 1) | 0 | 1 | 0 | 1 | 0 | 1 | 0 | 1 | 0 | 1 | 0 | 1 |
| 1) When not used with PMBus, the CTRL input can be internally pulled up or down depending on if it is active high or low. When active low it will be pulled up and vice versa | DLS, PMBus Control (0x62) | DLS, Sec RC w/ pull up/down (0x83) | DLS, Power Good Push-pull, PMBus Control (0x86) | DLS, Power Good Push-pull, Sec. RC w/ pull up/down (0x87) | DLS, Power Good High Z when active, PMBus Control (0xA6) | DLS, Power Good High Z when active, Sec. RC w/ pull up/down (0xA7) | Stand alone, PMBus Control (0x00) | Stand alone, Sec RC w/ pull up/down (0x01) | Stand alone, Power Good Push-pull, PMBus Control (0x04) | Stand alone, Power Good Push-pull, Sec. RC w/ pull up/down (0x05) | Stand alone, Power Good High Z when active, PMBus Control (0x24) | Stand alone, Power Good High Z when active, Sec. RC w/ pull up/down (0x25) |

The MFR_MULTI_PIN_CONFIG can be reconfigured using the PMBus interface. Default configuration is set to Power Good Push-Pull (0x04) for stand alone variants and DLS Power Good Push-Pull (0x86) for Droop Load Share variants.

User customized settings

This product has 2 data storage set: Default data (Flex factory) and User data. The User data set’s priority is higher than the Default data. The User data area is empty while shipped to customer. After boot-up, if the controller found no data stored in User data area, it will load Default data instead.

BMR457 series Fully regulated Advanced Bus Converters
 Input 36-75 V, Output up to 25 A / 300 W

1/28701-FGC 101 1835 revE September 2017
 © Flex

Customer can change the RAM data and store the changes into flash memory by PMBUS Store_User_All, next power cycle will load the User data into RAM for execute. Store_Default_All is write protected to ensure the factory settings is always available for recovery.

Output Voltage Regulation

The BMR457 products are designed to be fully regulated within the plotted area. Operating outside this area is not recommended.

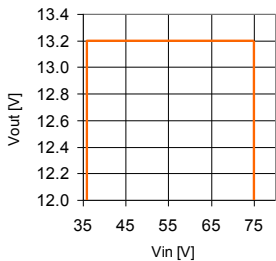

Vin range: 36-75Vdc
 BMR457xx04/xxx

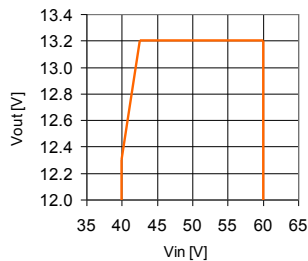

Vin range:40-60Vdc
 BMR457xx00/xxx

Thermal Consideration

General

The product is designed to operate in different thermal environments and sufficient cooling must be provided to ensure reliable operation.

For products mounted on a PWB without a heat sink attached, cooling is achieved mainly by conduction, from the pins to the host board, and convection, which is dependant on the airflow across the product. Increased airflow enhances the cooling of the product. The Output Current Derating graph found in the output section for each model provides the available output current vs. ambient air temperature and air velocity at $V_i=53V$.

The product is tested on a 254 x 254 mm, 35 μ m (1 oz), 16-layer test board mounted vertically in a wind tunnel with a cross-section of 608 x 203 mm.

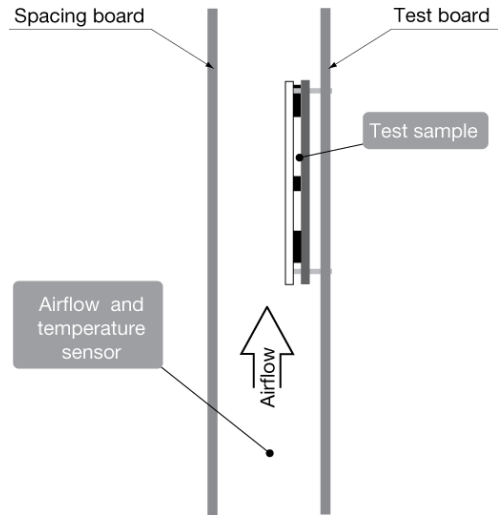

For products with base plate used in a sealed box/cold wall application, cooling is achieved mainly by conduction through the cold wall. The Output Current Derating graphs are found in the output section for each model. The product is tested in a sealed box test set up with ambient temperatures 85, 55 and 25°C. See Design Note 028 for further details.

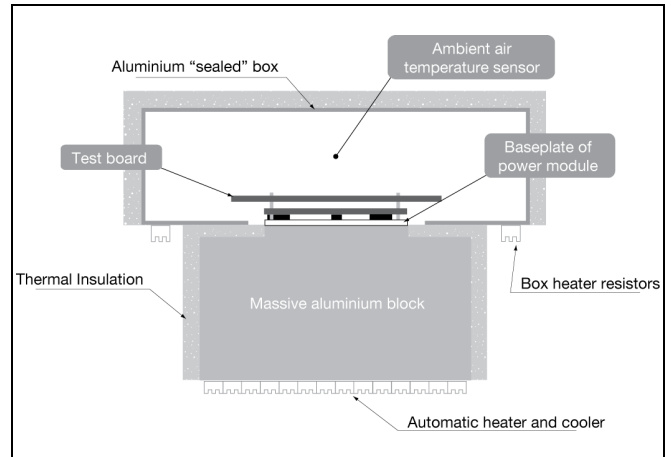

Definition of product operating temperature

The product operating temperature is used to monitor the temperature of the product, and proper thermal conditions can be verified by measuring the temperature at positions P1, P2, P3 and P4. The temperature at these positions (T_{P1} , T_{P2} , T_{P3} , T_{P4}) should not exceed the maximum temperatures in the table below. The number of measurement points may vary with different thermal design and topology. Temperatures above maximum T_{P1} , measured at the reference point P1 (both for openframe and base plate versions) are not allowed and may cause permanent damage.

BMR457 series Fully regulated Advanced Bus Converters
Input 36-75 V, Output up to 25 A / 300 W

1/28701-FGC 101 1835 revE September 2017

© Flex

| Position | Description | Max temperature |
|----------|--|-------------------------|
| P1 | PWB (reference point, open frame and base-plate) | T _{P1} =125° C |
| P2 | Opto-coupler | T _{P2} =105° C |
| P3 | Secondary MOSFET | T _{P3} =125° C |
| P4 | Magnetic Core | T _{P4} =125° C |

such as the PWB size, number of layers and direction of airflow.

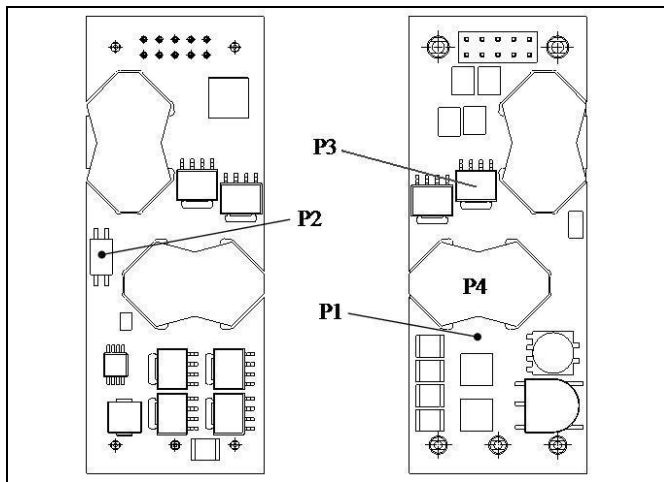

TOP View

Open frame

Bottom View

Open frame and Baseplate

(Best air flow direction is from negative to positive pins.)

Ambient Temperature Calculation

For products with base plate the maximum allowed ambient temperature can be calculated by using the thermal resistance.

1. The power loss is calculated by using the formula
 $((1/\eta) - 1) \times \text{output power} = \text{power losses (Pd)}$
 $\eta = \text{efficiency of product. E.g. } 95\% = 0.95$

2. Find the thermal resistance (Rth) in the Thermal Resistance graph found in the Output section for each model. **Note that the thermal resistance can be significantly reduced if a heat sink is mounted on the top of the base plate.**

Calculate the temperature increase (ΔT).

$$\Delta T = R_{th} \times P_d$$

3. Max allowed ambient temperature is:

$$\text{Max } T_{P1} - \Delta T.$$

E.g. BMR 457 0004/001 at 2m/s:

$$1. ((\frac{1}{0.945}) - 1) \times 264 \text{ W} = 15.4 \text{ W}$$

$$2. 15.4 \text{ W} \times 3.4^\circ\text{C/W} = 52^\circ\text{C}$$

3. $125^\circ\text{C} - 52^\circ\text{C} = \text{max ambient temperature is } 73^\circ\text{C}$

The actual temperature will be dependent on several factors

Connections (Top view)

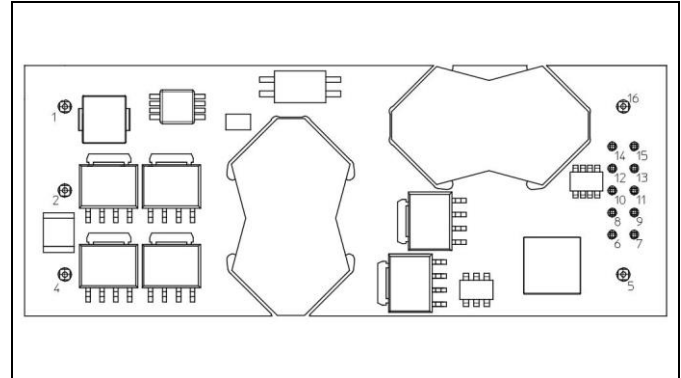

| Pin | Designation | Function |
|-----|-------------|-----------------------|
| 1 | +In | Positive Input |
| 2 | RC | Remote Control |
| 4 | -In | Negative Input |
| 5 | -Out | Negative Output |
| 6 | S+ | Positive Remote Sense |
| 7 | S- | Negative Remote Sense |
| 8 | SA0 | Address pin 0 |
| 9 | SA1 | Address pin 1 |
| 10 | SCL | PMBus Clock |
| 11 | SDA | PMBus Data |
| 12 | PG | Power Good output |
| 13 | DGND | PMBus ground |
| 14 | SALERT | PMBus alert signal |
| 15 | CTRL | PMBus remote control |
| 16 | +Out | Positive Output |

BMR457 series Fully regulated Advanced Bus Converters
 Input 36-75 V, Output up to 25 A / 300 W

1/28701-FGC 101 1835 revE September 2017
 © Flex

PMBus Interface

This product provides a PMBus digital interface that enables the user to configure many aspects of the device operation as well as to monitor the input and output voltages, output current and device temperature. The product can be used with any standard two-wire I²C or SMBus host device. In addition, the product is compatible with PMBus version 1.2 and includes an SALERT line to help mitigate bandwidth limitations related to continuous fault monitoring. The product supports 100 kHz and 400 kHz bus clock frequency only. The PMBus signals, SCL, SDA and SALERT require passive pull-up resistors as stated in the SMBus Specification. Pull-up resistors are required to guarantee the rise time as follows:

$$\text{Eq. 7 } \tau = R_p C_p \leq 1\mu\text{s}$$

where R_p is the pull-up resistor value and C_p is the bus load. The maximum allowed bus load is 400 pF. The pull-up resistor should be tied to an external supply between 2.7 to 5.5 V, which should be present prior to or during power-up. If the proper power supply is not available, voltage dividers may be applied. Note that in this case, the resistance in the equation above corresponds to parallel connection of the resistors forming the voltage divider.

It is recommended to always use PEC (Packet Error Check) when communicating via PMBus. For these products it is a requirement to use PEC when using Send Byte to the device, for example command "RESTORE_DEFAULT_ALL".

Monitoring via PMBus

A system controller (host device) can monitor a wide variety of parameters through the PMBus interface. The controller can monitor fault conditions by monitoring the SALERT pin, which will be asserted when any number of pre-configured fault or warning conditions occur. The system controller can also continuously monitor any number of power conversion parameters including but not limited to the following:

- Input voltage
- Output voltage
- Output current
- Internal junction temperature
- Switching frequency (Monitors the set value not actual frequency)
- Duty cycle

Software Tools for Design and Production

For this products Flex provides software for configuring and monitoring via the PMBus interface. For more information please contact your local Flex sales representative.

PMBus Addressing

The following figure and table show recommended resistor values with min and max voltage range for hard-wiring PMBus addresses (series E12, 1% tolerance resistors suggested):

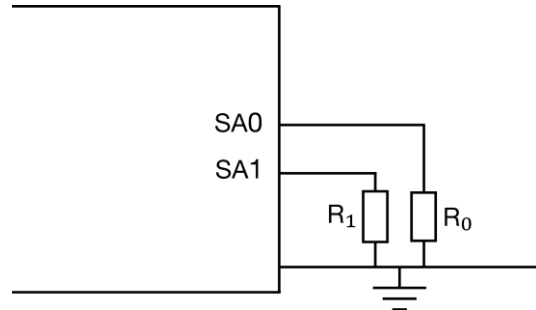

Schematic of connection of address resistors.

| SA0/SA1 Index | R _{SA0} /R _{SA1} [kΩ] |
|---------------|---|
| 0 | 10 |
| 1 | 22 |
| 2 | 33 |
| 3 | 47 |
| 4 | 68 |
| 5 | 100 |
| 6 | 150 |
| 7 | 220 |

The SA0 and SA1 pins can be configured with a resistor to GND according to the following equation.

$$\text{PMBus Address} = 8 \times (\text{SA0value}) + (\text{SA1 value})$$

If the calculated PMBus address is 0, 11 or 12, PMBus address 127 is assigned instead. From a system point of view, the user shall also be aware of further limitations of the addresses as stated in the PMBus Specification. It is not recommended to keep the SA0 and SA1 pins left open.

I²C/SMBus – Timing

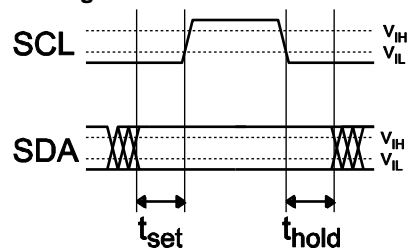

Setup and hold times timing diagram

The setup time, t_{set} , is the time data, SDA, must be stable before the rising edge of the clock signal, SCL. The hold time t_{hold} , is the time data, SDA, must be stable after the rising edge of the clock signal, SCL. If these times are violated incorrect data may be captured or meta-stability may occur and the bus communication may fail. When configuring the product, all standard SMBus protocols must be followed, including clock

BMR457 series Fully regulated Advanced Bus Converters
 Input 36-75 V, Output up to 25 A / 300 W

1/28701-FGC 101 1835 revE September 2017

© Flex

stretching. Additionally, a bus-free time delay between every SMBus transmission (between every stop & start condition) must occur. Refer to the SMBus specification, for SMBus electrical and timing requirements. Note that an additional delay of 5 ms has to be inserted in case of storing the RAM content into the internal non-volatile memory.

PMBus Commands

The products are PMBus compliant. The following table lists the implemented PMBus read commands. For more detailed information see PMBus Power System Management Protocol Specification; Part I – General Requirements, Transport and Electrical Interface and PMBus Power System Management Protocol; Part II – Command Language.

| Designation | Cmd | Prot |
|--------------------------------|-----|------|
| Standard PMBus Commands | | |
| Control Commands | | |
| OPERATION | 01h | No |
| ON_OFF_CONFIG | 02h | No |
| WRITE_PROTECT | 10h | No |
| Output Commands | | |
| VOUT_MODE | 20h | No |
| VOUT_COMMAND | 21h | No |
| VOUT_TRIM | 22h | No |
| VOUT_CAL_OFFSET | 23h | Yes |
| VOUT_MAX | 24h | No |
| VOUT_MARGIN_HIGH | 25h | No |
| VOUT_MARGIN_LOW | 26h | No |
| VOUT_TRANSITION_RATE | 27h | No |
| VOUT_SCALE_LOOP | 29h | Yes |
| VOUT_SCALE_MONITOR | 2Ah | Yes |
| MAX_DUTY | 32h | No |
| FREQUENCY_SWITCH | 33h | No |
| VIN_ON | 35h | No |
| VIN_OFF | 36h | No |
| IOUT_CAL_GAIN | 38h | Yes |
| IOUT_CAL_OFFSET | 39h | Yes |
| Fault Commands | | |
| VOUT_OV_FAULT_LIMIT | 40h | No |
| VOUT_OV_FAULT_RESPONSE | 41h | No |
| VOUT_OV_WARN_LIMIT | 42h | No |
| VOUT_UV_WARN_LIMIT | 43h | No |
| VOUT_UV_FAULT_LIMIT | 44h | No |
| VOUT_UV_FAULT_RESPONSE | 45h | No |
| IOUT_OC_FAULT_LIMIT | 46h | No |

| Designation | Cmd | Prot |
|-------------------------------------|-----|------|
| IOUT_OC_FAULT_RESPONSE | 47h | No |
| IOUT_OC_LV_FAULT_LIMIT | 48h | No |
| IOUT_OC_WARN_LIMIT | 4Ah | No |
| OT_FAULT_LIMIT | 4Fh | No |
| OT_FAULT_RESPONSE | 50h | No |
| OT_WARN_LIMIT | 51h | No |
| UT_WARN_LIMIT | 52h | No |
| UT_FAULT_LIMIT | 53h | No |
| UT_FAULT_RESPONSE | 54h | No |
| VIN_OV_FAULT_LIMIT | 55h | No |
| VIN_OV_FAULT_RESPONSE | 56h | No |
| VIN_OV_WARN_LIMIT | 57h | No |
| VIN_UV_WARN_LIMIT | 58h | No |
| VIN_UV_FAULT_LIMIT | 59h | No |
| VIN_UV_FAULT_RESPONSE | 5Ah | No |
| POWER_GOOD_ON | 5Eh | No |
| POWER_GOOD_OFF | 5Fh | No |
| Time setting Commands | | |
| TON_DELAY | 60h | No |
| TON_RISE | 61h | No |
| TON_MAX_FAULT_LIMIT | 62h | No |
| TON_MAX_FAULT_RESPONSE | 63h | No |
| TOFF_DELAY | 64h | No |
| TOFF_FALL | 65h | No |
| TOFF_MAX_WARN_LIMIT | 66h | No |
| Status Commands (Read Only) | | |
| CLEAR_FAULTS | 03h | No |
| STATUS_BYTES | 78h | No |
| STATUS_WORD | 79h | No |
| STATUS_VOUT | 7Ah | No |
| STATUS_IOUT | 7Bh | No |
| STATUS_INPUT | 7Ch | No |
| STATUS_TEMPERATURE | 7Dh | No |
| STATUS_CML | 7Eh | No |
| STATUS_OTHER | 7Fh | No |
| Monitor Commands (Read Only) | | |
| READ_VIN | 88h | No |
| READ_VOUT | 8Bh | No |
| READ_IOUT | 8Ch | No |
| READ_TEMPERATURE_1 | 8Dh | No |
| READ_TEMPERATURE_2 | 8Eh | No |
| READ_DUTY_CYCLE | 94h | No |

BMR457 series Fully regulated Advanced Bus Converters
 Input 36-75 V, Output up to 25 A / 300 W

1/28701-FGC 101 1835 revE September 2017

© Flex

| Designation | Cmd | Prot |
|---|-----|------|
| READ_FREQUENCY | 95h | No |
| Configuration and Control Commands | | |
| USER_DATA_00 | B0h | No |
| Identification Commands (Read Only) | | |
| PMBUS_REVISION | 98h | No |
| MFR_ID | 99h | Yes |
| MFR_MODEL | 9Ah | Yes |
| MFR_REVISION | 9Bh | Yes |
| MFR_LOCATION | 9Ch | Yes |
| MFR_DATE | 9Dh | Yes |
| MFR_SERIAL | 9Eh | Yes |
| Supervisory Commands | | |
| STORE_DEFAULT_ALL | 11h | Yes |
| RESTORE_DEFAULT_ALL | 12h | No |
| STORE_USER_ALL | 15h | No |
| RESTORE_USER_ALL | 16h | No |
| CAPABILITY | 19h | No |
| Product Specific Commands | | |
| MFR_POWER_GOOD_POLARITY | D0h | No |
| MFR_VIN_SCALE_MONITOR | D3h | Yes |
| MFR_SELECT_TEMP_SENSOR | DCh | No |
| MFR_VIN_OFFSET | DDh | Yes |
| MFR_VOUT_OFFSET_MONITOR | DEh | Yes |
| MFR_TEMP_OFFSET_INT | E1h | No |
| MFR_REMOTE_TEMP_CAL | E2h | No |
| MFR_REMOTE_CTRL | E3h | No |
| MFR_DEAD_BAND_DELAY | E5h | Yes |
| MFR_TEMP_COEFF | E7h | Yes |
| MFR_DEBUG_BUFF | F0h | No |
| MFR_SETUP_PASSWORD | F1h | No |
| MFR_DISABLE_SECURITY_ONCE | F2h | No |
| MFR_DEAD_BAND_IOUT_THRESHOLD | F3h | Yes |
| MFR_SECURITY_BIT_MASK | F4h | Yes |
| MFR_PRIMARY_TURN | F5h | Yes |
| MFR_SECONDARY_TURN | F6h | Yes |
| MFR_ILIM_SOFTSTART | F8h | No |
| MFR_MULTI_PIN_CONFIG | F9h | No |
| MFR_DEAD_BAND_VIN_THRESHOLD | FAh | Yes |
| MFR_DEAD_BAND_VIN_IOUT_HYS | FBh | Yes |
| MFR_RESTART | FEh | No |

Notes:

Cmd, is short for Command.

Prot, is short for commands that are protected with security mask.

BMR457 series Fully regulated Advanced Bus Converters
 Input 36-75 V, Output up to 25 A / 300 W

1/28701-FGC 101 1835 revE September 2017
 © Flex

Mechanical Information - Hole Mount, Open Frame Version

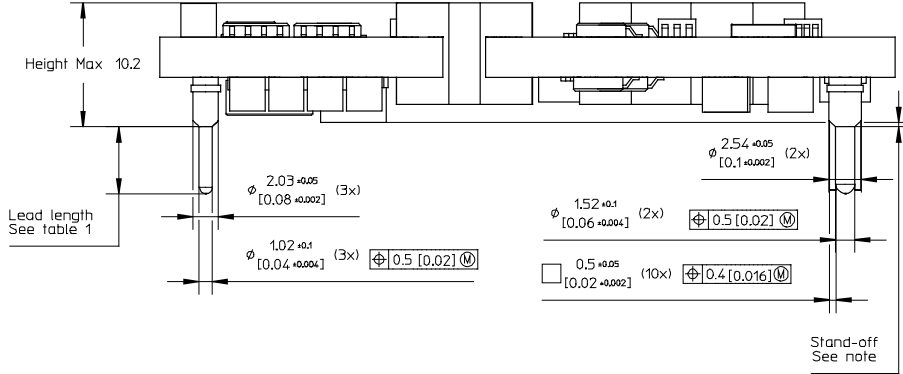

| X1 | Lead length |
|----|--------------------|
| 0 | 5.33 [0.210] |
| 2 | 3.69 [0.145] (cut) |
| 3 | 4.57 [0.180] (cut) |
| 4 | 2.79 [0.110] (cut) |

TOP VIEW

Pin positions according to recommended footprint

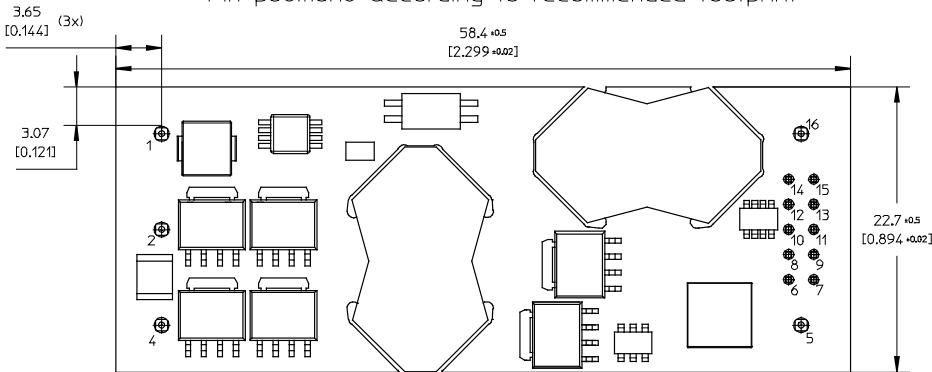

Table 1.
 X1 = Ordering information

PIN SPECIFICATIONS
 Pin 1-5 & 16 Material: Copper alloy
 Plating: Min Au 0.1 μ m over 1-3 μ m Ni.
 Pin 6-15 Material: Brass
 Plating: Min Au 0.2 μ m over 1.3 μ m Ni.

NOTE
 Pin 6-15 are optional and only used if digital communication is required.

Stand-off to none conductive components min 0.15mm [0.006]
 Stand-off to conductive components min 1.25mm [0.049]

Pin position 3 not present due to case to ground pin not available on BMR457

RECOMMENDED FOOTPRINT - TOP VIEW

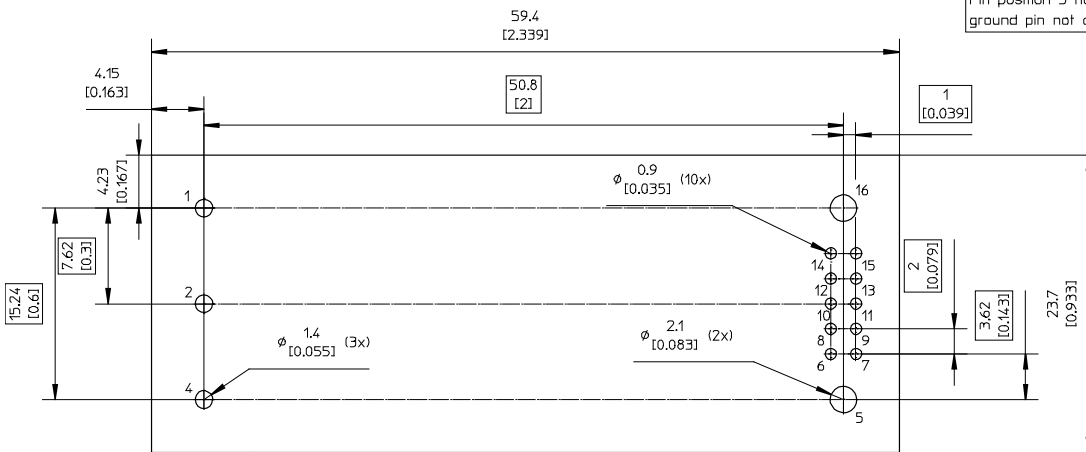

Weight: Typical 26 g
 All dimensions in mm (inch)
 Tolerances unless specified:
 x.x \pm 0.50 [0.02], x.xx \pm 0.25 [0.01]
 (not applied on footprint or typical values)

Recommended keep away area for user components.
 The stand-off in combination with insulating material ensures that requirements as per IEC/EN/UL60950 are met and 2250 V isolation maintained even if open vias or traces are present under the DC/DC converter.



BMR457 series Fully regulated Advanced Bus Converters
Input 36-75 V, Output up to 25 A / 300 W

1/28701-FGC 101 1835 revE September 2017
© Flex

Mechanical Information - Hole Mount, Base Plate Version

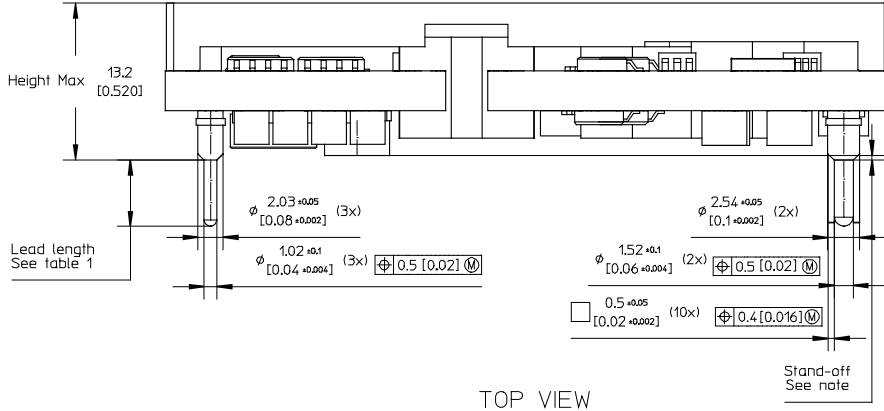

TOP VIEW

Pin positions according to recommended footprint

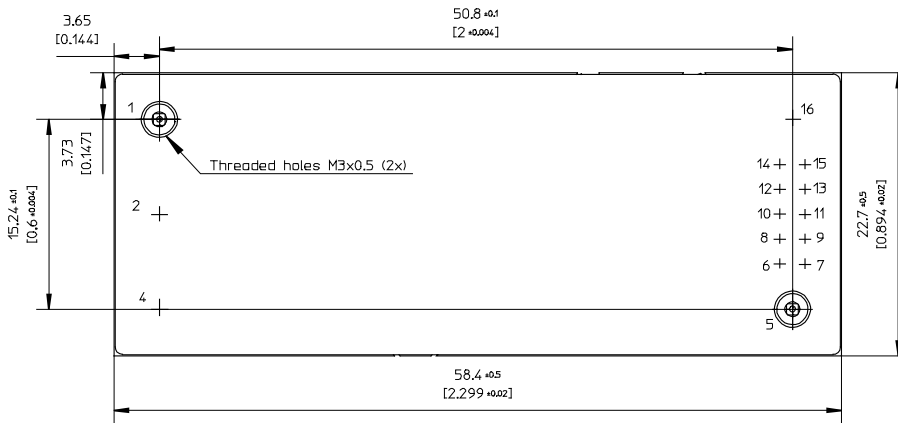

RECOMMENDED FOOTPRINT - TOP VIEW

| X1 | Lead length |
|----|--------------------|
| 0 | 5.33 [0.210] |
| 2 | 3.69 [0.145] (cut) |
| 3 | 4.57 [0.180] (cut) |
| 4 | 2.79 [0.110] (cut) |

Table 1.
X1= Ordering information

CASE
Material: Aluminium
For screw attachment apply mounting torque of max 0.44 Nm [3.9 lbf in].
M3 screws must not protrude more than 2.7 mm [0.106] into the base plate.

PIN SPECIFICATIONS
Pin 1-5 & 16 Material: Copper alloy
Plating: Min Au 0.1 μ m over 1-3 μ m Ni.
Pin 6-15 Material: Brass
Plating: Min Au 0.2 μ m over 1.3 μ m Ni.

NOTE
Pin 6-15 are optional and only used if digital communication is required.

Stand-off to none conductive components min 0.15mm [0.006]
Stand-off to conductive components min 1.25mm [0.049]

Pin position 3 not present due to case to ground pin not available on BMR457

Weight: Typical: 38 g
All dimensions in mm [inch]
Tolerances unless specified:
x.x +0.50 [0.02]
x.xx+0.25 [0.01]
(not applied on footprint or typical values)



Recommended keep away area for user components.
The stand-off in combination with insulating material ensures that requirements as per IEC/EN/UL60950 are met and 2250 V isolation maintained even if open vias or traces are present under the DC/DC converter.

BMR457 series Fully regulated Advanced Bus Converters
 Input 36-75 V, Output up to 25 A / 300 W

1/28701-FGC 101 1835 revE September 2017

© Flex

Mechanical Information - Surface Mount Version

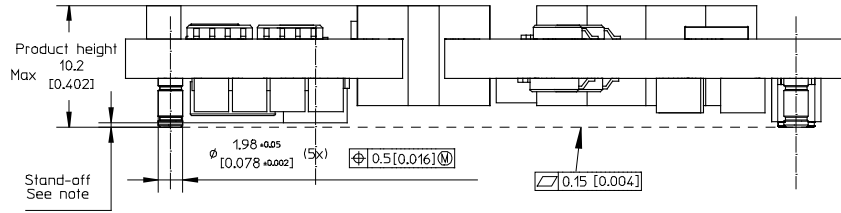
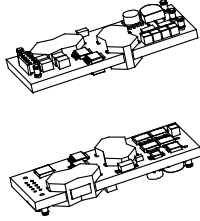

TOP VIEW

Pin positions according to recommended footprint

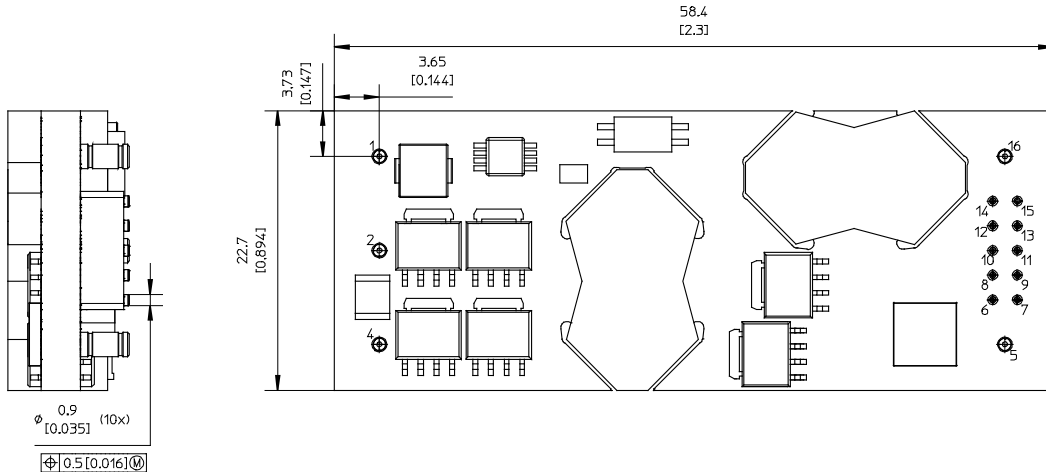

RECOMMENDED FOOTPRINT - TOP VIEW

NOTES

PIN SPECIFICATIONS

Pin 1-5 & 16 Material: Copper alloy
 Plating: Min Au 0.1 µm over 1-3 µm Ni.
 Pin 6-15 Material: Brass
 Plating: Min Au 0.2 µm over 1.3 µm Ni.
 Pin 6-15 are optional and only used if digital communication is required.
 Pin position 3 not present due to case to ground pin not available on BMR457

Stand-off to none conductive components min 0.15mm [0.006]
 Stand-off to conductive components min 1.25mm [0.049]

Weight: Typical 24 g

All dimensions in mm [inch].
 Tolerances unless specified:
 x.x ±0.5 [0.02]
 x.xx±0.25 [0.01]
 (not applied on footprint or typical values)

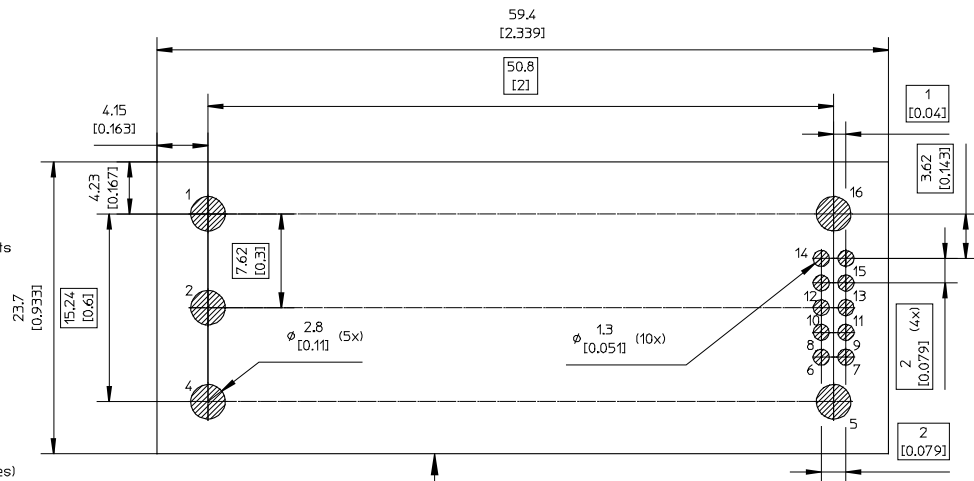

Recommended keep away area for user components.
 The stand-off in combination with insulating material ensures that requirements as per IEC/EN/UL60950 are met and 2250 V isolation maintained even if open vias or traces are present under the DC/DC converter.



BMR457 series Fully regulated Advanced Bus Converters Input 36-75 V, Output up to 25 A / 300 W

1/28701-FGC 101 1835 revE September 2017

© Flex

Soldering Information - Surface Mounting

The surface mount product is intended for forced convection or vapor phase reflow soldering in SnPb and Pb-free processes.

The reflow profile should be optimised to avoid excessive heating of the product. It is recommended to have a sufficiently extended preheat time to ensure an even temperature across the host PWB and it is also recommended to minimize the time in reflow.

A no-clean flux is recommended to avoid entrapment of cleaning fluids in cavities inside the product or between the product and the host board, since cleaning residues may affect long time reliability and isolation voltage.

| General reflow process specifications | | SnPb eutectic | Pb-free |
|---|---------------|---------------|-----------|
| Average ramp-up ($T_{PRODUCT}$) | | 3°C/s max | 3°C/s max |
| Typical solder melting (liquidus) temperature | T_L | 183°C | 221°C |
| Minimum reflow time above T_L | | 60 s | 60 s |
| Minimum pin temperature | T_{PIN} | 210°C | 235°C |
| Peak product temperature | $T_{PRODUCT}$ | 225°C | 260°C |
| Average ramp-down ($T_{PRODUCT}$) | | 6°C/s max | 6°C/s max |
| Maximum time 25°C to peak | | 6 minutes | 8 minutes |

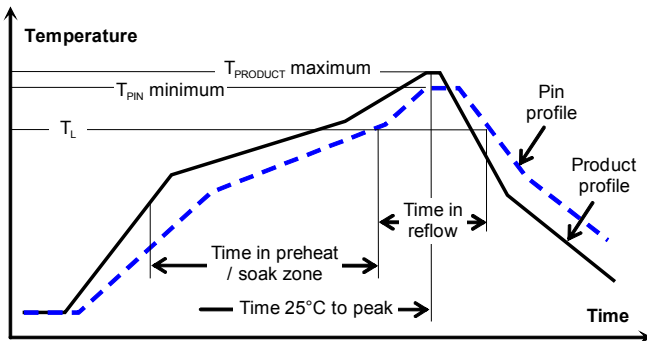

Minimum Pin Temperature Recommendations

Pin number 5 chosen as reference location for the minimum pin temperature recommendation since this will likely be the coolest solder joint during the reflow process.

SnPb solder processes

For SnPb solder processes, a pin temperature (T_{PIN}) in excess of the solder melting temperature, (T_L , 183°C for Sn63Pb37) for more than 60 seconds and a peak temperature of 220°C is recommended to ensure a reliable solder joint.

For dry packed products only: depending on the type of solder paste and flux system used on the host board, up to a recommended maximum temperature of 245°C could be used, if the products are kept in a controlled environment (dry pack handling and storage) prior to assembly.

Lead-free (Pb-free) solder processes

For Pb-free solder processes, a pin temperature (T_{PIN}) in excess of the solder melting temperature (T_L , 217 to 221°C for SnAgCu solder alloys) for more than 60 seconds and a peak temperature of 245°C on all solder joints is recommended to ensure a reliable solder joint.

Maximum Product Temperature Requirements

Top of the product PWB near pin 2 is chosen as reference location for the maximum (peak) allowed product temperature ($T_{PRODUCT}$) since this will likely be the warmest part of the product during the reflow process.

SnPb solder processes

For SnPb solder processes, the product is qualified for MSL 1 according to IPC/JEDEC standard J-STD-020C.

During reflow $T_{PRODUCT}$ must not exceed 225 °C at any time.

Pb-free solder processes

For Pb-free solder processes, the product is qualified for MSL 3 according to IPC/JEDEC standard J-STD-020C.

During reflow $T_{PRODUCT}$ must not exceed 260 °C at any time.

Dry Pack Information

Products intended for Pb-free reflow soldering processes are delivered in standard moisture barrier bags according to IPC/JEDEC standard J-STD-033 (Handling, packing, shipping and use of moisture/reflow sensitivity surface mount devices).

Using products in high temperature Pb-free soldering processes requires dry pack storage and handling. In case the products have been stored in an uncontrolled environment and no longer can be considered dry, the modules must be baked according to J-STD-033.

Thermocoupler Attachment

Top of PWB near pin 2 for measurement of maximum product temperature, $T_{PRODUCT}$

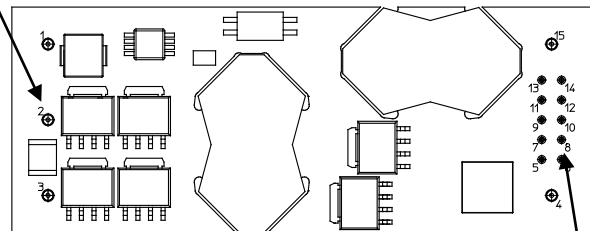

Pin 5 for measurement of minimum pin (solder joint) temperature, T_{PIN}

BMR457 series Fully regulated Advanced Bus Converters
 Input 36-75 V, Output up to 25 A / 300 W

1/28701-FGC 101 1835 revE September 2017
 © Flex

Soldering Information - Hole Mounting

The hole mounted product is intended for plated through hole mounting by wave or manual soldering. The pin temperature is specified to maximum to 270°C for maximum 10 seconds.

A maximum preheat rate of 4°C/s and maximum preheat temperature of 150°C is suggested. When soldering by hand, care should be taken to avoid direct contact between the hot soldering iron tip and the pins for more than a few seconds in order to prevent overheating.

A no-clean flux is recommended to avoid entrapment of cleaning fluids in cavities inside the product or between the product and the host board. The cleaning residues may affect long time reliability and isolation voltage.

Delivery Package Information

The products are delivered in antistatic injection molded trays (Jedec design guide 4.10D standard) and in antistatic trays.

| Tray Specifications – SMD /Pin in paste | |
|---|--|
| Material | Antistatic PPE |
| Surface resistance | $10^5 < \text{Ohm/square} < 10^{12}$ |
| Bakability | The trays can be baked at maximum 125°C for 48 hours |
| Tray thickness | 17.40 mm 0.685 [inch] |
| Box capacity | 100 products (5 full trays/box) |
| Tray weight | 125 g empty, 605 g full tray |

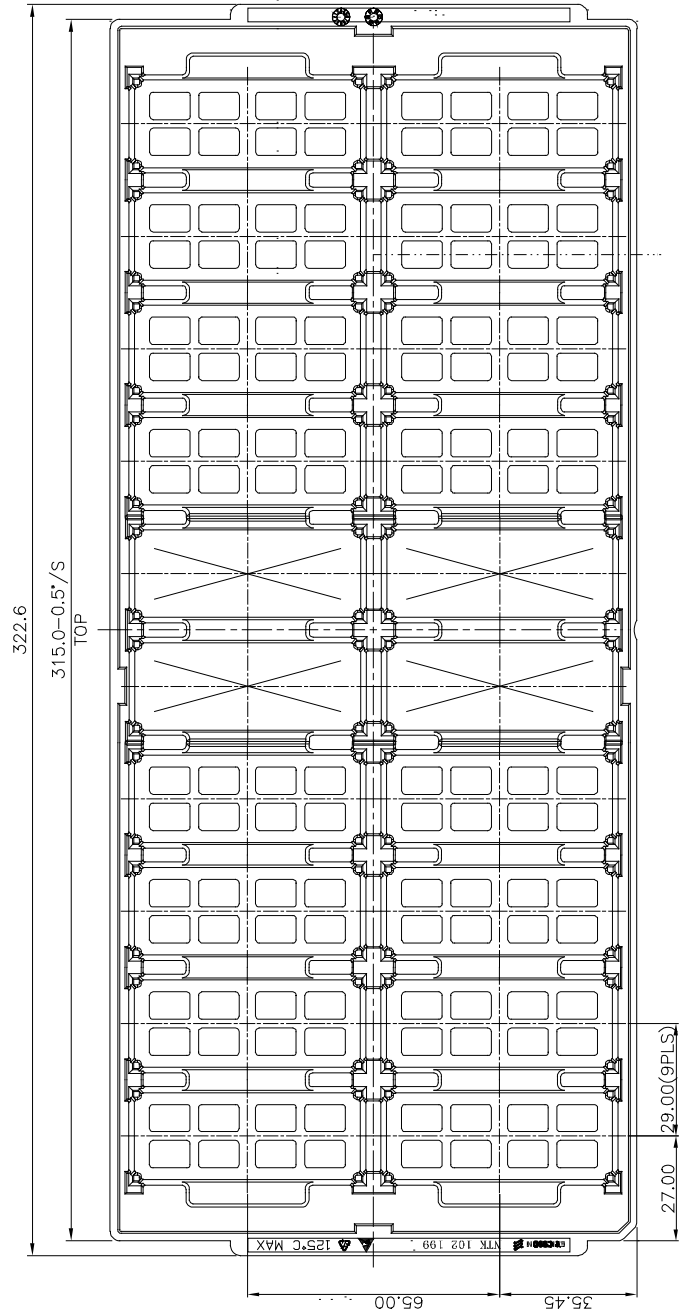

JEDEC standard tray for 2x5 = 10 products.
 All dimensions in mm [inch]
 Tolerances: X.x ±0.26 [0.01], X.xx ±0.13 [0.005]
 Note: pick up positions refer to center of pocket.
 See mechanical drawing for exact location on product.

BMR457 series Fully regulated Advanced Bus Converters
 Input 36-75 V, Output up to 25 A / 300 W

1/28701-FGC 101 1835 revE September 2017

© Flex

| Tray Specifications – Through hole Version | |
|--|---|
| Material | PE Foam, dissipative |
| Surface resistance | $10^5 < \text{Ohm/square} < 10^{12}$ |
| Bakability | The trays are not bakeable |
| Tray capacity | 25 converters/tray |
| Box capacity | 75 products (3 full trays/box) |
| Weight | Product – Open frame 790 g full tray, 140g empty tray Product – Base plate option 1090 g full tray, 140 g empty tray |

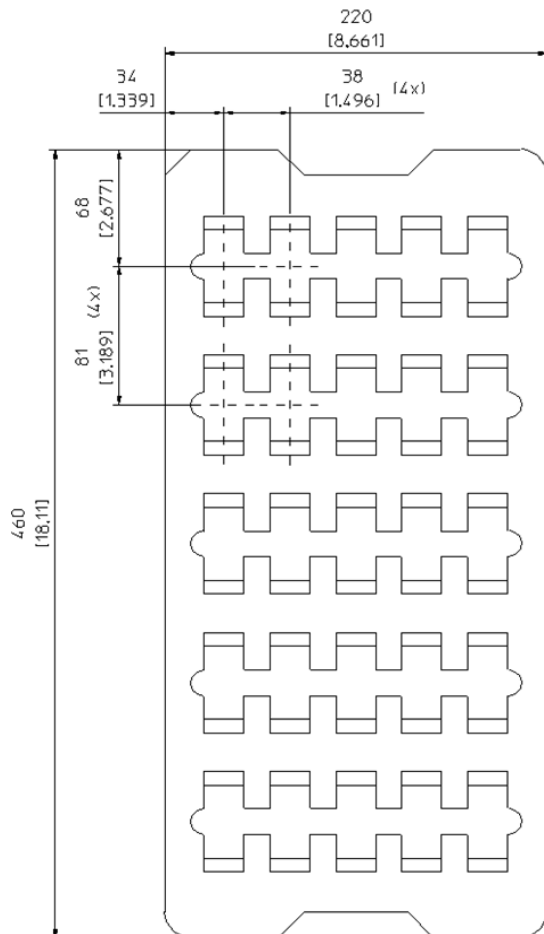

BMR457 series Fully regulated Advanced Bus Converters
 Input 36-75 V, Output up to 25 A / 300 W

1/28701-FGC 101 1835 revE September 2017

© Flex

Product Qualification Specification

| Characteristics | | | |
|---|--|---|---|
| External visual inspection | IPC-A-610 | | |
| Change of temperature (Temperature cycling) | IEC 60068-2-14 Na | Temperature range Number of cycles Dwell/transfer time | -40 to 100°C 500 15 min/0-1 min |
| Cold (in operation) | IEC 60068-2-1 Ad | Temperature T _A Duration | -45°C 72 h |
| Damp heat | IEC 60068-2-67 Cy | Temperature Humidity Duration | 85°C 85 % RH 1000 hours |
| Dry heat | IEC 60068-2-2 Bd | Temperature Duration | 125°C 1000 h |
| Electrostatic discharge susceptibility | IEC 61340-3-1, JESD 22-A114 IEC 61340-3-2, JESD 22-A115 | Human body model (HBM) Machine Model (MM) | Class 2, 2000 V Class 3, 200 V |
| Immersion in cleaning solvents | IEC 60068-2-45 XA, method 2 | Water Glycol ether Isopropyl alcohol | 55°C 35°C 35°C |
| Mechanical shock | IEC 60068-2-27 Ea | Peak acceleration Duration | 100 g 6 ms |
| Moisture reflow sensitivity ¹ | J-STD-020C | Level 1 (SnPb-eutectic) Level 3 (Pb Free) | 225°C 260°C |
| Operational life test | MIL-STD-202G, method 108A | Duration | 1000 h |
| Resistance to soldering heat ² | IEC 60068-2-20 Tb, method 1A | Solder temperature Duration | 270°C 10-13 s |
| Robustness of terminations | IEC 60068-2-21 Test Ua1 IEC 60068-2-21 Test Ue1 | Through hole mount products Surface mount products | All leads All leads |
| Solderability | IEC 60068-2-58 test Td ¹ | Preconditioning Temperature, SnPb Eutectic Temperature, Pb-free | 150°C dry bake 16 h 215°C 235°C |
| | IEC 60068-2-20 test Ta ² | Preconditioning Temperature, SnPb Eutectic Temperature, Pb-free | Steam ageing 235°C 245°C |
| Vibration, broad band random | IEC 60068-2-64 Fh, method 1 | Frequency Spectral density Duration | 10 to 500 Hz 0.07 g ² /Hz 10 min in each direction |



Notes

¹ Only for products intended for reflow soldering (surface mount products)







² Only for products intended for wave soldering (plated through hole products)

Looking for pricing, stock, or lifecycle information?

Click below to explore more details on WIN SOURCE:

-  [View BMR4570004/001 on WIN SOURCE](#)
-  [Flex Power Modules Information](#)

Optimize Your Supply Chain with WIN SOURCE Solutions

-  Global Sourcing Solution
-  Obsolete Management
-  Cost Control Management
-  Shortage Management
-  Alternative Solution
-  Excess Inventory Management