

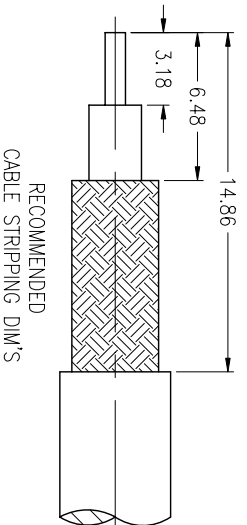

THE DATASHEET OF
000-28000



(S):



THIRD ANGLE PROJ.

REVISIONS		DATE	ECO	APPR
REV	DESCRIPTION			
A	RELEASE TO MFG.	--	--	--
B	SEE SHEET 1	10-Mar-08	--	AW
Y	SEE SHEET 1	23-Dec-09	47888	SH
AA	STAMP "AMPHENOL" WAS "74868\RD-DM1120601R3	19-Dec-11	48842	SH

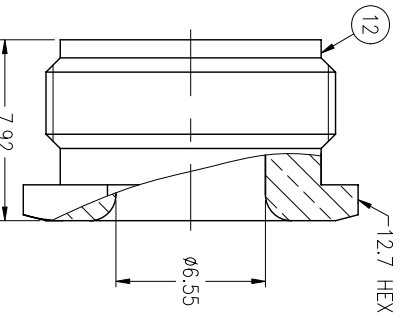
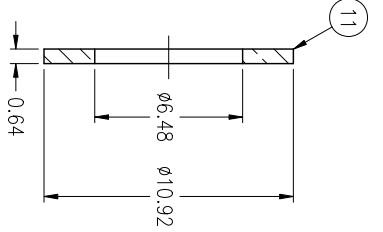
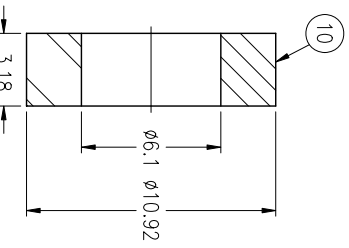
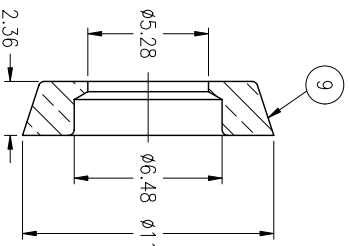
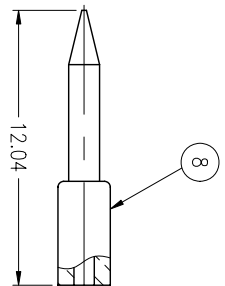
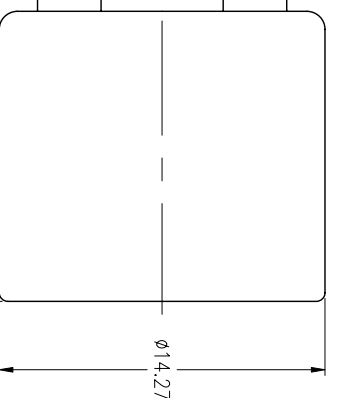



CUSTOMER OUTLINE DRAWING
ALL OTHER SHEETS ARE FOR INTERNAL USE ONLY

AREA:	MATERIAL:	DRAWN:	DATE:	TITLE:	DRAWING NO.	Amphenol RF
		R. MAO	12-Dec-11	MINI H.V. PLUG FOR RG59/U	28000	Danbury CT USA, Tainan Taiwan, Shenzhen China
		ENGINEER	DATE	CABLE 5000V UG-932/U	ITEM NO.	www.amphenolrf.com
		C. WANG	23-Dec-09	SCALE: 3/1	28000	
		APPROVED	DATE	DWG SIZE	2 OF 2	
		S. SHIEH	12-Dec-11	B	REV	
		CAD FILE		CODE ID	AA	
		F:\DWG\CMPD\28000-AMSZ		74868		
		FINISH				

Looking for pricing, stock, or lifecycle information?

Click below to explore more details on WIN SOURCE:

-  [View 000-28000 on WIN SOURCE](#)
-  [Amphenol Information](#)

Optimize Your Supply Chain with WIN SOURCE Solutions

-  Global Sourcing Solution
-  Obsolete Management
-  Cost Control Management
-  Shortage Management
-  Alternative Solution
-  Excess Inventory Management