



**THE DATASHEET OF
CR023573F**



Thick Film Chip Resistor

CR Series

MERITEK

FEATURE

- Excellent Mechanical Strength and Electrical Stability
- Ideal for Pick and Place Machinery
- Stable High Frequency Characteristics
- Miniature, High Board Density
- Equivalent Specification EIAJ-RC-2690, EIAJ-RC-1009B, EIA-RS-481A



PART NUMBERING SYSTEM



CR 10 1002 F - 13
(1) (2) (3) (4) (5)

No	Item	Code	Description	Series Reference
(1)	Meritek Series	CR	Thick Film	Chip Resistor
(2)	Size	10	10: 0805	01: 2512, 02: 2010, 03: 1812, 04: 1210 08: 1206, 16: 0603, 20: 0402, 25: 0201
(3)	Resistance	1002	1002: 10KΩ	3 Digit: First 2 are significant, Last is multiplier (10 ^X) 4 Digit: First 3 are significant, Last is multiplier (10 ^X)
(4)	Tolerance	F	F: ±1%	B: ±0.1%, D: ±0.5%, G: ±2%, J: ±5%
(5)	Packaging	13	13: 13" reel	Blank: Standard 7" reel

ELECTRICAL CHARACTERISTICS

Resistance Range: ≥ 1Ω & 0Ω

Type	Rated Power 70°C	Max Working Voltage	Max Overload Voltage	T.C.R. (ppm/°C)	Resistance Range (Ω)				Jumper Rated Current		Jumper Resistance	
					B(±1%) E-24, E-96	D(±0.5%) E-24, E-96	F(±1%) E-24, E-96	G(±2%) J(±5%) E-24	J (±5%)	F (±1%)	J (±5%)	F (±1%)
CR25 (0201)	1/20W	25V	50V	-200 +400	-	1≤R<10	1≤R<10	1≤R<10	0.5A	0.5A	50mΩ Max	35mΩ Max
				±200	47~1M	10~10M	10~10M					
CR20 (0402)	1/16W	50V	100V	±100	100~1M	10~1M	10~22M	10~22M	1A	1.5A	50mΩ Max	20mΩ Max
				±200	-	-	1≤R<10	1≤R<10				
CR16 (0603)	1/10W	75V	150V	±100	100~1M	10~1M	10~22M	10~22M	1A	2A	50mΩ Max	20mΩ Max
				±200	-	1≤R<10	1≤R<10	1≤R<10				
CR10 (0805)	1/8W	150V	300V	±100	100~1M	10~10M	10~27M	10~27M	2A	2.5A	50mΩ Max	20mΩ Max
				±200	-	1≤R<10	1≤R<10	1≤R<10				
CR08 (1206)	1/4W	200V	400V	±100	10~1M	10~10M	10~27M	10~27M	2A	3.5A	50mΩ Max	20mΩ Max
				±200	3≤R<10	1≤R<10	1≤R<10	1≤R<10				
CR04 (1210)	1/2W	200V	400V	±100	100~1M	10~10M	10~27M	10~27M	2A	4A	50mΩ Max	20mΩ Max
				±200	-	-	1≤R<10	1≤R<10				
CR03 (1812)	3/4W	200V	400V	±100	100~1M	10~10M	10~20M	10~20M	2A	5A	50mΩ Max	20mΩ Max
				±200	-	-	1≤R<10	1≤R<10				
CR02 (2010)	3/4W	200V	400V	±100	100~1M	10~10M	10~20M	10~20M	2A	5A	50mΩ Max	20mΩ Max
				±200	-	-	1≤R<10	1≤R<10				
CR01 (2512)	1W	200V	400V	±100	100~1M	10~10M	10~20M	10~20M	2A	7A	50mΩ Max	20mΩ Max
				±200	-	-	1≤R<10	1≤R<10				
Operating Temperature				-55~+155°C (0201: -55~+125°C)								

Thick Film Chip Resistor

CR Series

MERITEK

ELECTRICAL CHARACTERISTICS (CONTINUED)

Resistance Range: <1Ω

Type	Rated Power 70°C	Max Rated Current	Max Overload Current	T.C.R. (ppm/°C)	Resistance Range (mΩ)
					F (±1%), G (±2%), J (±5%)
CR20 (0402)	1/16W	1.58A	3.95A	±1500	25~37
				±1200	37~60
				±600	60~200
				±300	200~400
				±250	400~600
				±200	600~1000
CR16 (0603)	1/10W	3.16A	7.91A	±1500	10~37
				±1200	37~60
				±600	60~100
				±300	100~200
				±600	200~500
				±400	500~1000
CR10 (0805)	1/8W	3.53A	8.82A	±1500	10~19
				±1200	19~33
				±800	33~50
				±600	50~100
				±200	100~1000
CR08 (1206)	1/3W	5.77A	14.42A	±1500	10~19
				±1200	19~25
				±1000	25~50
				±600	50~100
				±200	100~1000
CR04 (1210)	1/2W	7.07A	17.67A	±1500	10~19
				±1000	19~25
				±700	25~50
				±400	50~100
				±200	100~1000
CR03 (1812)	3/4W	8.66A	21.65A	±1500	10~19
				±1200	19~25
				±900	25~50
				±500	50~100
				±200	100~1000
CR02 (2010)	3/4W	8.66A	21.65A	±1500	10~19
				±1200	19~25
				±900	25~50
				±500	50~100
				±200	100~1000
CR01 (2512)	1W	10A	25A	±1500	10~19
				±1200	19~25
				±900	25~50
				±500	50~100
				±200	100~1000
Operating Temperature				-55 ~ +155°C	

DIMENSIONS

Resistance Range: $\geq 1\Omega$ & 0Ω

Type	Size	Dimensions (mm)				
		L	W	H	L1	L2
CR25	0201	0.60±0.03	0.30±0.03	0.23±0.03	0.10±0.05	0.15±0.05
CR20	0402	1.00±0.10	0.50±0.05	0.30±0.05	0.20±0.10	0.25±0.10
CR16	0603	1.60±0.10	0.80±0.10	0.45±0.10	0.30±0.15	0.30±0.15
CR10	0805	2.00±0.10	1.25±0.10	0.50±0.10	0.35±0.20	0.35±0.15
CR08	1206	3.05±0.10	1.55±0.10	0.50±0.10	0.45±0.20	0.35±0.15
CR04	1210	3.05±0.10	2.55±0.10	0.55±0.10	0.50±0.20	0.50±0.20
CR03	1812	4.40±0.20	3.15±0.20	0.47±0.20	0.60±0.20	0.60±0.20
CR02	2010	5.00±0.20	2.50±0.20	0.55±0.10	0.60±0.20	0.60±0.20
CR01	2512	6.30±0.20	3.20±0.20	0.55±0.10	0.60±0.20	0.60±0.20

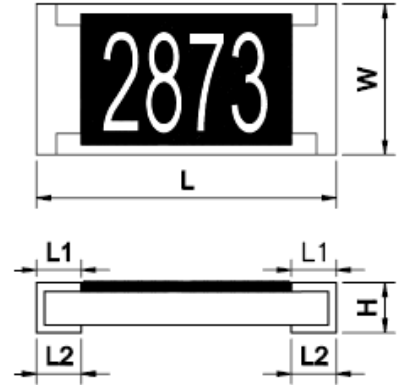

Resistance Range: $< 1\Omega$

Type	Size	Dimensions (mm)				
		L	W	H	L1	L2
CR20	0402	1.00±0.10	0.50±0.05	0.30±0.10	0.25±0.10	0.20±0.15
CR16	0603	1.60±0.10	0.80±0.10	0.45±0.10	0.25±0.15	0.35±0.15
CR10	0805	2.00±0.10	1.25±0.10	0.50±0.10	0.35±0.20	0.35±0.20
CR08	1206	3.05±0.10	1.55±0.10	0.50±0.10	0.45±0.20	0.55±0.25
CR04	1210	3.05±0.10	2.55±0.10	0.55±0.10	0.50±0.20	0.50±0.20
CR03	1812	4.40±0.20	3.15±0.20	0.47±0.20	0.60±0.20	0.60±0.20
CR02	2010	5.00±0.20	2.50±0.20	0.60±0.10	0.65±0.20	0.65±0.20
CR01	2512	6.30±0.20	3.20±0.20	0.60±0.10	0.65±0.20	0.65±0.20

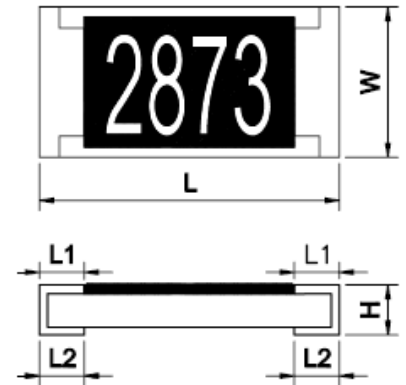

POWER DERATING CURVE

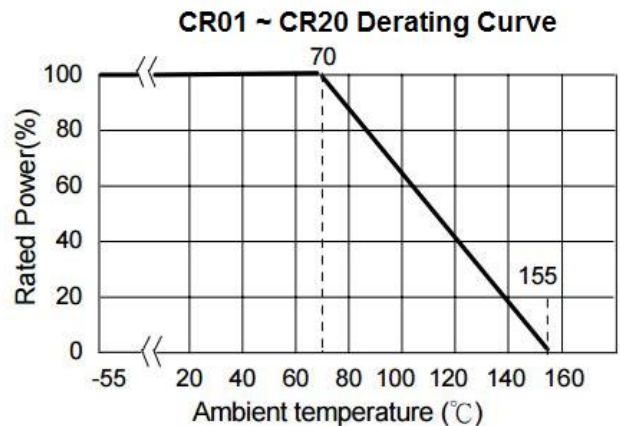
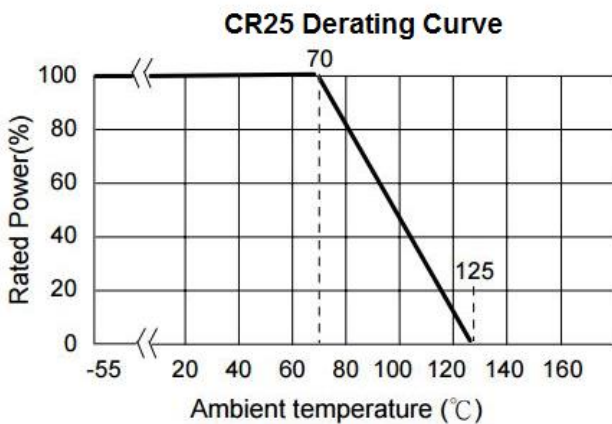

RELIABILITY TEST CONDITIONS AND REQUIREMENTS

Item	Standard	Test Conditions	Requirements														
Temperature Coefficient of Resistance	JIS-C5201-1 4.8	$T.C.R = \frac{(R2-R1)}{R1 (T2-T1)} \times 10^6,$ R1: Resistance at Room Temperature R2: Resistance at -55°C or +125°C T1: Room Temperature T2: -55°C or +125°C	As Specified														
Short Time Overload	JIS-C5201-1 4.13	Apply 2.5 times rated voltage for 5 seconds and release the load for about 30 minutes, then measure. Apply maximum overload current for jumpers.	Resistance $\geq 1\Omega$: 0.1%, 0.5%, 1%: $\pm(1.0\%+0.05\Omega)$ 2%, 5%: $\pm(2.0\%+0.10\Omega)$ Resistance $< 1\Omega$: 1%, 2%, 5%: $\pm(2.0\%+0.001\Omega)$ Jumper: As Specified No evidence of mechanical damage No short or burned appearance														
Insulation Resistance	JIS-C5201-1 4.6	Put the resistor in the fixture and apply 100VDC for 1 min. Then measure the insulation resistance between electrodes and insulating enclosure or between electrodes and base material.	$\geq 10^9\Omega$														
Dielectric Withstand Voltage	JIS-C5201-1 4.7	Put the resistor in the fixture and apply: CR01,02,03,04,08,10 : 500VAC for 1 minute CR16,20,25 : 300VAC for 1 minute	No short or burned appearance														
Intermittent Overload	JIS-C5201-1 4.13	Put the tested resistor into test chamber of $25\pm 2^\circ\text{C}$ and load 2.5 times rated voltage for 1 sec. on, 25 sec. off. Test for 10,000 ~ 10,400 cycles. Leave the resistor at no load for 1 hr before measuring. Apply max overload current for jumper.	Resistance $\geq 1\Omega$: $\pm(5.0\%+0.10\Omega)$ Resistance $< 1\Omega$: $\pm(5.0\%+0.001\Omega)$ Jumper: As Specified No evidence of mechanical damage No short or burned appearance														
Noise Level	JIS-C5201-1 4.12	Refer to JIS-C5201-1 4.12	<table border="1"> <thead> <tr> <th>Resistance</th> <th>Noise</th> </tr> </thead> <tbody> <tr> <td>$< 100\Omega$</td> <td>$\leq -10\text{db}$ (0.32 $\mu\text{V/V}$)</td> </tr> <tr> <td>100~1KΩ</td> <td>$\leq 0\text{db}$ (1.0 $\mu\text{V/V}$)</td> </tr> <tr> <td>1KΩ~10KΩ</td> <td>$\leq 10\text{db}$ (3.2 $\mu\text{V/V}$)</td> </tr> <tr> <td>10K~100KΩ</td> <td>$\leq 15\text{db}$ (5.6 $\mu\text{V/V}$)</td> </tr> <tr> <td>100K~1MΩ</td> <td>$\leq 20\text{db}$ (10 $\mu\text{V/V}$)</td> </tr> <tr> <td>$> 1\text{M}\Omega$</td> <td>$\leq 30\text{db}$ (32 $\mu\text{V/V}$)</td> </tr> </tbody> </table>	Resistance	Noise	$< 100\Omega$	$\leq -10\text{db}$ (0.32 $\mu\text{V/V}$)	100~1K Ω	$\leq 0\text{db}$ (1.0 $\mu\text{V/V}$)	1K Ω ~10K Ω	$\leq 10\text{db}$ (3.2 $\mu\text{V/V}$)	10K~100K Ω	$\leq 15\text{db}$ (5.6 $\mu\text{V/V}$)	100K~1M Ω	$\leq 20\text{db}$ (10 $\mu\text{V/V}$)	$> 1\text{M}\Omega$	$\leq 30\text{db}$ (32 $\mu\text{V/V}$)
Resistance	Noise																
$< 100\Omega$	$\leq -10\text{db}$ (0.32 $\mu\text{V/V}$)																
100~1K Ω	$\leq 0\text{db}$ (1.0 $\mu\text{V/V}$)																
1K Ω ~10K Ω	$\leq 10\text{db}$ (3.2 $\mu\text{V/V}$)																
10K~100K Ω	$\leq 15\text{db}$ (5.6 $\mu\text{V/V}$)																
100K~1M Ω	$\leq 20\text{db}$ (10 $\mu\text{V/V}$)																
$> 1\text{M}\Omega$	$\leq 30\text{db}$ (32 $\mu\text{V/V}$)																
Core Body Strength	JIS-C5201-1 4.15	Apply R0.5 test probe at its central part then pushing 10N force on the sample for 10 sec. CR16,20: Probe R0.2	Resistance $\geq 1\Omega$: $\pm(1.0\%+0.05\Omega)$ Resistance $< 1\Omega$: $\pm(1.0\%+0.001\Omega)$ No evidence of mechanical damage No short or burned appearance														
Terminal Strength	JIS-C5201-1 4.16	<u>Test 1:</u> Mount the resistor on the board and apply 5N pushing force on the sample. Read for 10 sec. (CR25: 3N) <u>Test2:</u> Mount the resistor on the board and slowly add force onto the terminal until it breaks.	<u>Test 1:</u> No evidence of mechanical damage <u>Test 2:</u> CR25 $\geq 3\text{N}$ Other type $\geq 5\text{N}$														
Resistance to Solvent	JIS-C5201-1 4.29	Immerse the resistor into isopropyl alcohol of 20~25 °C for 5 min. Leave the resistor at room temperature for 48 hrs before measuring.	Resistance $\geq 1\Omega$: CR25: $\pm(1.0\%+0.05\Omega)$ Others: $\pm(0.5\%+0.05\Omega)$ Resistance $< 1\Omega$: $\pm(1.0\%+0.001\Omega)$ No evidence of mechanical damage No G2 overcoating and Sn layer														
Solderability	JIS-C5201-1 4.17	<u>Preconditioning:</u> Place the resistor in the PCT apparatus at 105°C, 100% RH, and 1.22x10 ⁵ Pa for 4 hrs. Leave the resistor at room temperature for 48 hrs before test <u>Test Method:</u> Immerse the resistor into a solder pot at 235 \pm 5°C for 2 sec. Leave the resistor under a microscope to observe its solder area.	95% coverage minimum														

RELIABILITY TEST CONDITIONS AND REQUIREMENTS (CONTINUED)

Item	Standard	Test Conditions	Requirements								
Resistance to Soldering Heat	JIS-C5201-1 4.18	<p><u>Test method 1:</u> Immerse the resistor in molten solder of 260~265°C for 10 sec. Then leave the resistor at room temperature for 1 hr.</p> <p><u>Test method 2:</u> Immerse the resistor in molten solder of 260~265°C for 30 sec. Leave the resistor under a microscope to observe its solder area.</p> <p><u>Test method 3:</u> Preheating temperature: 350±10°C Electric iron preheating time: 3~4 sec Place the preheated iron on the electrode termination for 60 mins. and measure.</p>	<p><u>Test item 1 and 3:</u> Resistance ≥1Ω: ±(1.0%+0.05Ω) Resistance <1Ω: ±(1.0%+0.001Ω) No evidence of electrode damage No side conductive peeling off.</p> <p><u>Test item 2:</u> Solder coverage over 95% The underlying material shall not be visible at the crest corner area of electrode.</p>								
Joint Strength of Solder	JIS-C5201-1 4.32 JIS-C5201-1 4.33	<p><u>Preconditioning:</u> Same as Solderability Preconditioning</p> <p><u>Test item 1:</u> Apply a static load using a R0.5 (CR25: R0.1) scratch tool to the core of the component in the direction of the arrow for 10 seconds. Measure under load: CR25: 5N, CR20: 10N, Others: 20N</p> <p><u>Test item 2:</u> Solder the resistor onto PC board and apply downward force, measure under load Amplitude: CR20,16,10: 5mm, CR25,08,04: 3mm, CR03,02,01: 2mm</p>	<p><u>Test item 1 and 2:</u> Resistance ≥1Ω: ±(1.0%+0.05Ω) Resistance <1Ω: ±(1.0%+0.001Ω) No evidence of mechanical damage No terminal peeling off.</p>								
Vibration	JIS-C5201-1 4.22	Mount the resistor by its leads to the supporting terminals on the solid table. Apply frequency 10Hz ~ 55Hz and return to 10Hz in a period of 1 min. at an amplitude of 1.5mm. Apply this motion for 2 hrs in each mutually perpendicular directions (total 6 hrs)	<p>Resistance ≥1Ω: 0.1%, 0.5%, 1%: ±(0.5%+0.05Ω) 2%, 5%: ±(1.0%+0.05Ω) Resistance <1Ω: 1%, 2%, 5%: ±(1.0%+0.001Ω) No evidence of mechanical damage</p>								
Resistance to Dry Heat	JIS-C5201-1 4.25	Put tested resistor into the test chamber of 155±5°C for 1000~1048 hrs. Leave the resistor at room temperature for 1 hour before measuring. (CR25: 125±3°C)	<p>Resistance ≥1Ω: 0.1%, 0.5%, 1%: ±(1.0%+0.05Ω) 2%, 5%: ±(2.0%+0.10Ω) Resistance <1Ω: 1%, 2%, 5%: ±(1.0%+0.001Ω) No evidence of mechanical damage No short or burned appearance</p>								
Thermal Shock	MIL-STD 202 Method 107	Put tested resistor into the test chamber used in Thermal Shock which is shown in the following table. Cycle 300 times consecutively. Leave the resistor at room temperature for 1 hr before measuring.	<p>Resistance ≥1Ω: 0.1%, 0.5%, 1%: ±(0.5%+0.05Ω) 2%, 5%: ±(1.0%+0.05Ω) Resistance <1Ω: 1%, 2%, 5%: ±(1.0%+0.001Ω) No evidence of mechanical damage No short or burned appearance</p>								
		<table border="1"> <thead> <tr> <th colspan="2">Testing Condition</th> </tr> </thead> <tbody> <tr> <td>Lowest Temperature</td> <td>-55±5°C</td> </tr> <tr> <td>Highest Temperature</td> <td>125±5°C</td> </tr> <tr> <td>Time at each Temp.</td> <td>15 minutes each</td> </tr> </tbody> </table>	Testing Condition		Lowest Temperature	-55±5°C	Highest Temperature	125±5°C	Time at each Temp.	15 minutes each	
Testing Condition											
Lowest Temperature	-55±5°C										
Highest Temperature	125±5°C										
Time at each Temp.	15 minutes each										
Load Life in Moisture	JIS-C5201-1 4.24	Put the tested resistor into the test chamber of 40±2°C, 90~95% RH, and load the rated voltage for 90 mins "ON", 30 min "OFF", total 1000 hrs. Leave the resistor at room temperature for 1 hr before measuring.	<p>Resistance ≥1Ω: CR25: 1% ± (1.0%+0.05Ω) 5% ± (3.0%+0.1Ω) Others: 0.1%, 0.5%, 1%: ±(0.5%+0.05Ω) 2%, 5%: ±(2.0%+0.10Ω) Resistance <1Ω: 1%, 2%, 5%: ±(1.0%+0.001Ω) No evidence of mechanical damage No short or burned appearance</p>								
Load Life	JIS-C5201-1 4.25	Put the tested resistor into the test chamber of 70±2°C, and load the rated voltage for 90 mins "ON", 30 min "OFF", total 1000 hrs. Leave the resistor at room temperature for 1 hr before measuring.	<p>Resistance ≥1Ω: CR25: 1% ± (1.0%+0.05Ω) 5% ± (3.0%+0.1Ω) Others: 0.1%, 0.5%, 1%: ±(0.5%+0.05Ω) 2%, 5%: ±(2.0%+0.10Ω) Resistance <1Ω: 1%, 2%, 5%: ±(1.0%+0.001Ω) No evidence of mechanical damage No short or burned appearance</p>								

RELIABILITY TEST CONDITIONS AND REQUIREMENTS (CONTINUED)

Item	Standard	Test Conditions	Requirements
Low Temperature Operation	MIL-R-55342D 4.7.4	Put tested resistor into the test chamber at room temperature. Decrease the temperature to -55°C and maintain this temperature for 1 hr. Load the rated voltage for 45 min "ON", and 15 min "OFF." Then leave the tested resistor at room temperature for 8±1 hrs., and measure.	Resistance ≥1Ω: 0.1%, 0.5%, 1%: ±(0.5%+0.05Ω) 2%, 5%: ±(1.0%+0.05Ω) Resistance <1Ω: 1%, 2%, 5%: ±(1.0%+0.001Ω) No evidence of mechanical damage No short or burned appearance
Whisker Test	JESD Standard NO.22A121 class 2	Thermal Shock Test 1500 cycles. Inspect for whisker formation.	Max 50µm

RECOMMENDED SOLDERING PROFILES

Reflow Condition		
Pre Heat	Temp. Min $T_{s(min)}$	150°C
	Temp. Max $T_{s(max)}$	180°C
	Time (min. to max.) (t_s)	60~120 seconds
Average ramp up rate (T_L) to peak		3°C/second max.
$T_{s(max)}$ to T_L (Ramp-up rate)		3°C/second max.
Reflow	Temp. (T_L)	230°C
	Time (min. to max.) (t_L)	40 seconds max.
Peak Temperature (T_p)		260~265°C
Time within 5°C of actual peak Temperature (t_p)		10 seconds max.
Ramp-down Rate		6°C/second

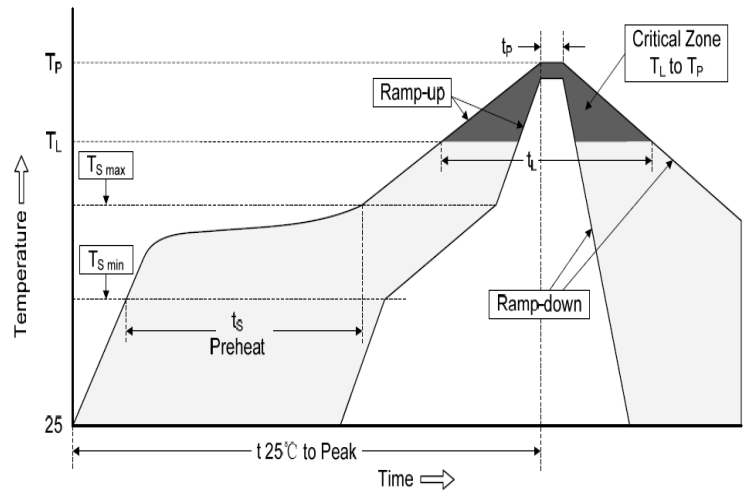

RECOMMENDED LAND PATTERN

Type	Dimensions (mm)		
	A	B	C
CR25	0.3	1.0	0.4
CR20	0.5	1.5	0.6
CR16	0.8	2.1	0.9
CR10	1.2	3.0	1.3
CR08	2.2	4.2	1.6
CR04	2.2	4.2	2.8
CR03	3.1	5.9	3.0
CR02	3.5	6.1	2.8
CR01	3.8	8.0	3.5

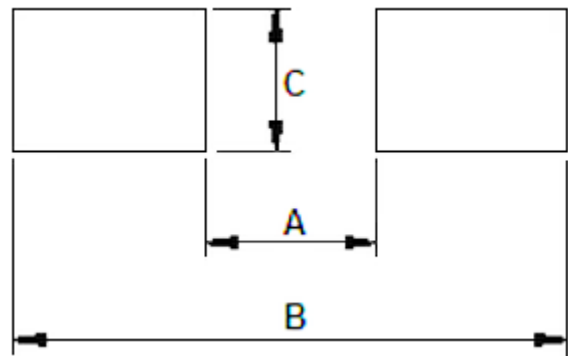

TAPE AND REEL DIMENSIONS

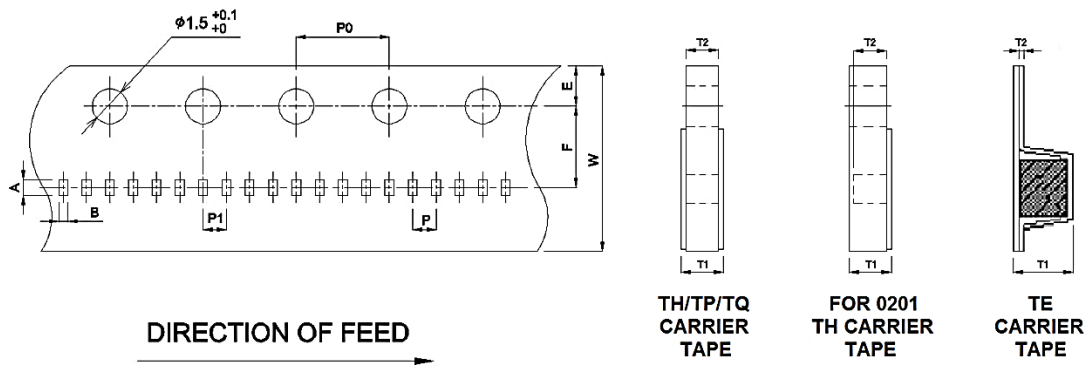

Tape Dimensions (mm)												
Type	Tape	A	B	W	E	F	T1	T2	P	P0	10 X P0	P1
CR25	TQ Paper	0.68 ±0.05	0.38 ±0.03	8.00 ±0.10	1.75 ±0.10	3.50 ±0.05	0.42 +0.1/-0	0.28 ±0.02	1.00 ±0.05	4.00 ±0.05	40.00 ±0.20	1.00 ±0.05
CR25	TQ PE	0.68 ±0.03	0.38 ±0.03	8.00 ±0.10	1.75 ±0.10	3.50 ±0.05	0.38 ±0.05	0.30 ±0.02	1.00 ±0.05	4.00 ±0.05	40.00 ±0.20	1.00 ±0.05
CR25	TH Paper	0.68 ±0.05	0.38 ±0.03	8.00 ±0.10	1.75 ±0.10	3.50 ±0.05	0.42 +0.1/-0	0.28 ±0.02	2.00 ±0.05	4.00 ±0.05	40.00 ±0.20	2.00 ±0.05
CR25	TH PE	0.68 ±0.03	0.38 ±0.03	8.00 ±0.10	1.75 ±0.10	3.50 ±0.05	0.38 ±0.05	0.30 ±0.02	2.00 ±0.05	4.00 ±0.05	40.00 ±0.20	2.00 ±0.05
CR20	TH	1.15 ±0.05	0.65 ±0.05	8.00 ±0.20	1.75 ±0.10	3.50 ±0.05	0.40 +0.2/-0	0.40 ±0.05	2.00 ±0.10	4.00 ±0.05	40.00 ±0.20	2.00 ±0.05
CR16	TH	1.80 ±0.10	1.00 ±0.10	8.00 ±0.20	1.75 ±0.10	3.50 ±0.05	0.60 +0.2/-0	0.60 ±0.10	2.00 ±0.10	4.00 ±0.05	40.00 ±0.20	2.00 ±0.05
CR16	TP	1.80 ±0.10	1.00 ±0.10	8.00 ±0.20	1.75 ±0.10	3.50 ±0.05	0.60 +0.2/-0	0.60 ±0.10	4.00 ±0.10	4.00 ±0.05	40.00 ±0.20	2.00 ±0.05
CR10	TP	2.30 ±0.10	1.55 ±0.10	8.00 ±0.20	1.75 ±0.10	3.50 ±0.05	0.75 +0.2/-0	0.75 ±0.10	4.00 ±0.10	4.00 ±0.05	40.00 ±0.20	2.00 ±0.05
CR08	TP	3.50 ±0.20	1.90 ±0.20	8.00 ±0.20	1.75 ±0.10	3.50 ±0.05	0.75 +0.2/-0	0.75 ±0.10	4.00 ±0.10	4.00 ±0.05	40.00 ±0.20	2.00 ±0.05
CR04	TP	3.50 ±0.20	2.80 ±0.20	8.00 ±0.20	1.75 ±0.10	3.50 ±0.05	0.75 +0.2/-0	0.75 ±0.10	4.00 ±0.10	4.00 ±0.05	40.00 ±0.20	2.00 ±0.05
CR03	TE	4.90 ±0.10	3.40 ±0.10	12.00 ±0.20	1.75 ±0.10	5.50 ±0.05	0.75 ±0.10	0.23 ±0.02	4.00 ±0.10	4.00 ±0.10	40.00 ±0.20	2.00 ±0.05
CR02	TE	5.50 ±0.20	2.80 ±0.20	12.20 ±0.20	1.75 ±0.10	5.50 ±0.05	1.10 ±0.15	0.23 ±0.15	4.00 ±0.10	4.00 ±0.05	40.00 ±0.20	2.00 ±0.05
CR01	TE	6.70 ±0.20	3.40 ±0.20	12.00 ±0.20	1.75 ±0.10	5.50 ±0.05	1.10 ±0.15	0.23 ±0.15	4.00 ±0.10	4.00 ±0.05	40.00 ±0.20	2.00 ±0.05

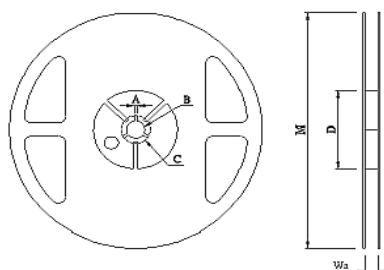

Reel Dimensions (mm)						
Reel Type/ Tape	Wa	M	A	B	C	D
7" reel for 8 mm tape	9.0 ± 0.5	178 ± 2.0	2.0 ± 0.5	13.5 ± 0.5	21.0 ± 0.5	60.0 ± 1.0
7" reel for 12 mm tape	13.8 ± 0.5	178 ± 2.0				80.0 ± 1.0
10" reel for 8 mm tape	10.0 ± 0.5	254 ± 2.0				100 ± 1.0
13" reel for 8 mm tape	10.0 ± 0.5	330 ± 2.0				100 ± 1.0

Thick Film Chip Resistor

CR Series

MERITEK

PACKAGING

Type	Tape Width (mm)	Packaging Quantity (pcs / reel)														
		TQ		TH								TP				TE
		Q1	QE	TH	H0	H1	H2	H3	H4	H5	H6	TP	P2	P3	P4	TE
CR25	8	20K	150K	10K	15K	20K	20K	30K	40K	50K	60K	-	-	-	-	-
CR20	8	-	-	10K	-	20K	20K	30K	40K	50K	60K	-	-	-	-	-
CR16	8	-	-	-	-	-	-	-	40K	-	-	5K	10K	15K	20K	-
CR10	8	-	-	-	-	-	-	-	-	-	-	5K	10K	15K	20K	-
CR08	8	-	-	-	-	-	-	-	-	-	-	5K	10K	15K	20K	-
CR04	8	-	-	-	-	-	-	-	-	-	-	5K	10K	15K	20K	-
CR03	12	-	-	-	-	-	-	-	-	-	-	-	-	-	-	4K
CR02	12	-	-	-	-	-	-	-	-	-	-	-	-	-	-	4K
CR01	12	-	-	-	-	-	-	-	-	-	-	-	-	-	-	4K
Reel Type		7"	13"	7"	7"	7"	10"	10"	13"	13"	13"	7"	10"	13"	13"	7"
Pitch (mm)		1	1	2	2	2	2	2	2	2	2	4	4	4	4	4

Meritek Resistors Series: <http://www.meritekusa.com/EN/productlist/node/2>

Meritek Product Series: <http://www.meritekusa.com/EN/products>

*Specifications subject to change without notice.

Looking for pricing, stock, or lifecycle information?

Click below to explore more details on WIN SOURCE:

- ⊖ [View CR023573F on WIN SOURCE](#)
- ⊖ [Meritek Information](#)

Optimize Your Supply Chain with WIN SOURCE Solutions

- ✓ Global Sourcing Solution
- ✓ Obsolete Management
- ✓ Cost Control Management
- ✓ Shortage Management
- ✓ Alternative Solution
- ✓ Excess Inventory Management