



**THE DATASHEET OF**  
**7490140117C**



# Spezifikation für Freigabe / specification for release

Kunde / customer :  
 Artikelnummer / part number : **7490140117C**  
 Bezeichnung : **LAN-Übertrager WE-LAN High Voltage**  
 description : **LAN-Transformer WE-LAN High Voltage**



DATUM / DATE : 2019-01-25

## A Mechanische Abmessungen / dimensions :

	10/100 BaseT
--	--------------

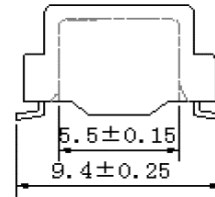
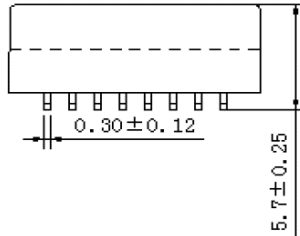
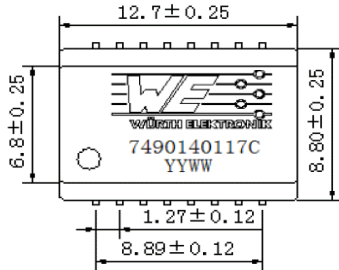

## B Elektrische Eigenschaften / electrical properties :

## C Lötpad / soldering spec. :

Eigenschaften / properties	Testbedingungen / test conditions		Wert / value	Einheit / unit	tol.
Induktivität / Inductance	100kHz / 100mV @ 8mA DC-Bias	OCL	350	µH	min.
Übersetzungsverhältnis / Turns ratio	100kHz / 100mV	TR	1 : 1	Tx	±3%
			1 : 1	Rx	
Insertion Loss	1-100MHz	IL	-1,3	dB	max.
Return Loss	1-30MHz	RL	-18	dB	min.
	30-60MHz		-13		
	60-80MHz		-10		
	80-100MHz		-8		
Common Mode Rejection Ratio	1-30MHz	CMRR	-42	dB	min.
	30-60MHz		-37		
	60-100MHz		-33		
Crosstalk	1-60MHz	CT	-33	dB	min.
	60-100MHz		-30		

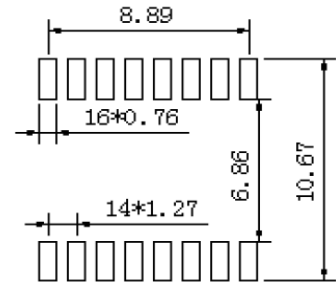

SUGGESTED PAD LAYOUT

## D Prüfgeräte / test equipment :

Agilent E5071C

## E Testbedingungen / test conditions :

Luftfeuchtigkeit / Humidity: 33%  
 Umgebungstemperatur / Temperature: +25°C

## F Werkstoffe & Zulassungen / material & approvals :

Basismaterial / Base material: Ferrit / Ferrite  
 Draht / Wire: FIW (pri.)QPN180 (sec.)  
 Kontaktmaterial / Contact plating: Cu-Ni-Sn  
 Gehäuse / Case: UL 94V-0

## G Eigenschaften / general specifications :

Betriebstemp. / Operating temperature: -40°C - +105°C  
 Hochspannungsprüfung / Hipot test: 2500Vrms 1min.  
 Designed gemäß IEC60601-1 mit 4mm min. Kriechstrecke und 2,4mm min. Luftstrecke für 1xMOOP  
 Designed to comply with IEC60601-1 with 4mm min. creepage distance and 2,4mm min. clearance distance for 1xMOOP  
 Basic insulation for 230 Vrms working voltage

Freigabe erteilt / general release:	<b>Kunde / customer</b>		
.....	.....	.....	.....
Datum / date	Unterschrift / signature		
.....	<b>Würth Elektronik</b>		
.....	.....	.....	.....
Geprüft / checked	Kontrolliert / approved	JaB	Version 01
.....	.....	Name	Änderung / modification
.....	.....		Datum / date

## Würth Elektronik eiSos GmbH & Co.KG

D-74638 Waldenburg · Max-Eyth-Straße 1 - 3 · Germany · Telefon (+49) (0) 7942 - 945 - 0 · Telefax (+49) (0) 7942 - 945 - 400  
<http://www.we-online.com>

# Spezifikation für Freigabe / specification for release

Kunde / customer :  
 Artikelnummer / part number : **7490140117C**  
 Bezeichnung : **LAN-Übertrager WE-LAN High Voltage**  
 description : **LAN-Transformer WE-LAN High Voltage**



DATUM / DATE : 2019-01-25

**H Schaltbild / Schematics :**

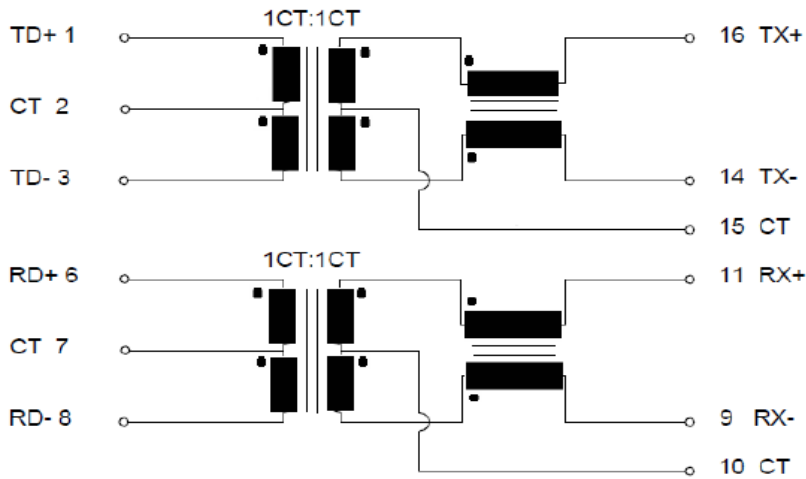

.....	.....	
Datum / date	Unterschrift / signature	
	<b>Würth Elektronik</b>	
.....	.....	
Geprüft / checked	Kontrolliert / approved	
		JaB      Version 01      2019-01-25
		Name      Änderung / modification      Datum / date

**Würth Elektronik eiSos GmbH & Co.KG**

D-74638 Waldenburg · Max-Eyth-Straße 1 - 3 · Germany · Telefon (+49) (0) 7942 - 945 - 0 · Telefax (+49) (0) 7942 - 945 - 400  
<http://www.we-online.com>

# Spezifikation für Freigabe / specification for release

Kunde / customer :  
 Artikelnummer / part number : **7490140117C**  
 Bezeichnung : **LAN-Übertrager WE-LAN High Voltage**  
 description : **LAN-Transformer WE-LAN High Voltage**



DATUM / DATE : 2019-01-25

## I Rollenspezifikation / tape and reel specification :

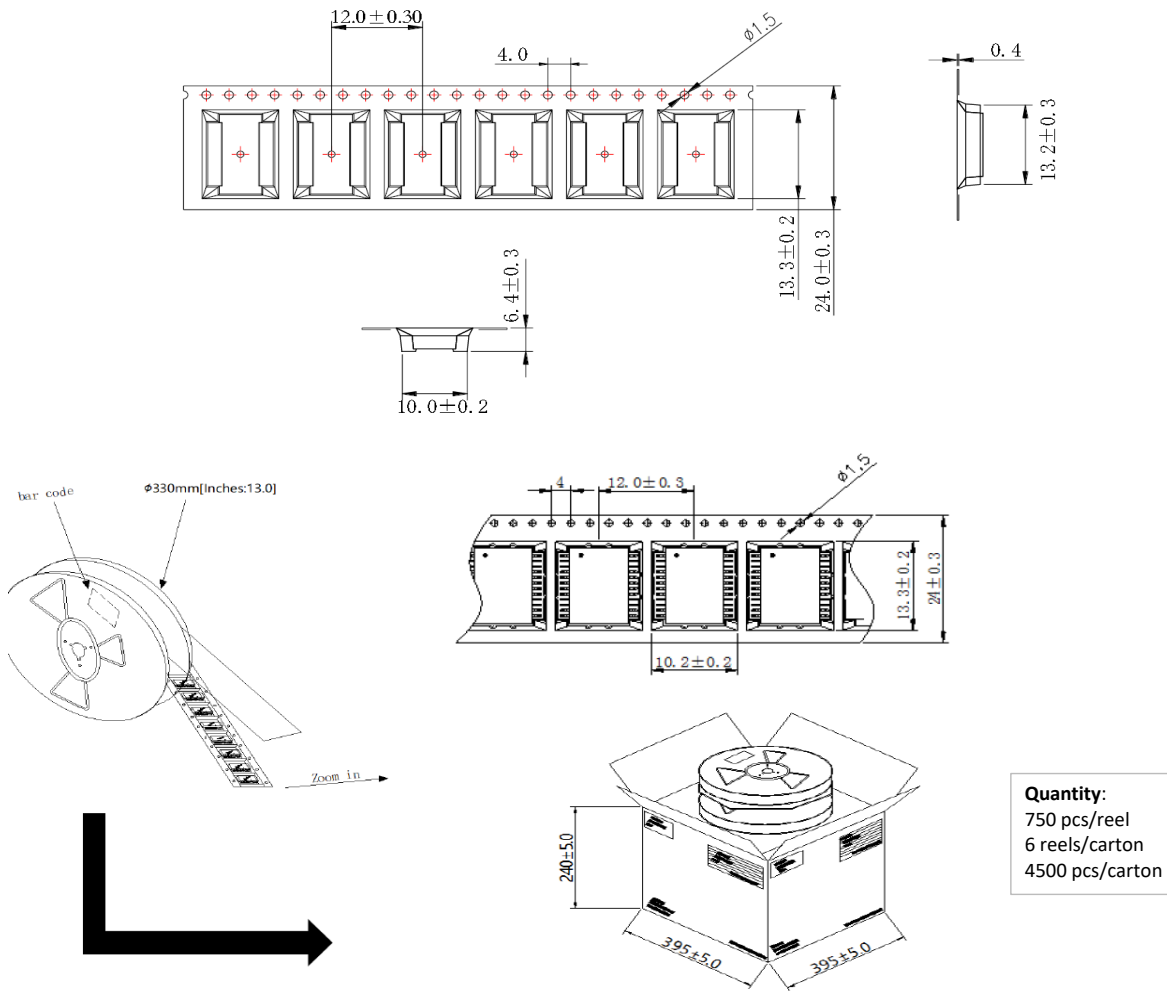

Freigabe erteilt / general release:	Kunde / customer			
Datum / date	Unterschrift / signature			
	<b>Würth Elektronik</b>			
Geprüft / checked	Kontrolliert / approved	JaB	Version 01	2019-01-25
		Name	Änderung / modification	Datum / date



This electronic component has been designed and developed for usage in general electronic equipment. Before incorporating this component into any equipment where higher safety and reliability is especially required or if there is the possibility of direct damage or injury to human body, for example in the range of aerospace, aviation, nuclear control, submarine, transportation, (automotive control, train control, ship control), transportation signal, disaster prevention, medical, public information network etc. Würth Elektronik eiSos GmbH must be informed before the design-in stage. In addition, sufficient reliability evaluation checks for safety must be performed on every electronic component which is used in electrical circuits that require high safety and reliability functions or performance.

### Würth Elektronik eiSos GmbH & Co.KG







D-74638 Waldenburg · Max-Eyth-Straße 1 - 3 · Germany · Telefon (+49) (0) 7942 - 945 - 0 · Telefax (+49) (0) 7942 - 945 - 400  
<http://www.we-online.com>

## Looking for pricing, stock, or lifecycle information?

Click below to explore more details on WIN SOURCE:

-  [View 7490140117C on WIN SOURCE](#)
-  [Wurth Electronics Inc Information](#)

## Optimize Your Supply Chain with WIN SOURCE Solutions

-  Global Sourcing Solution
-  Obsolete Management
-  Cost Control Management
-  Shortage Management
-  Alternative Solution
-  Excess Inventory Management