



**THE DATASHEET OF
SZNUD3112DMT1G**



Integrated Relay, Inductive Load Driver

NUD3112

This device is used to switch inductive loads such as relays, solenoids incandescent lamps, and small DC motors without the need of a free-wheeling diode. The device integrates all necessary items such as the MOSFET switch, ESD protection, and Zener clamps. It accepts logic level inputs thus allowing it to be driven by a large variety of devices including logic gates, inverters, and microcontrollers.

Features

- Provides a Robust Driver Interface Between D.C. Relay Coil and Sensitive Logic Circuits
- Optimized to Switch Relays of 12 V Rail
- Capable of Driving Relay Coils Rated up to 6.0 W at 12 V
- Internal Zener Eliminates the Need of Free-Wheeling Diode
- Internal Zener Clamp Routes Induced Current to Ground for Quieter Systems Operation
- Low $V_{DS(ON)}$ Reduces System Current Drain
- These Devices is Pb-Free, Halogen Free/BFR Free and are RoHS Compliant

Typical Applications

- Telecom: Line Cards, Modems, Answering Machines, FAX
- Computers and Office: Photocopiers, Printers, Desktop Computers
- Consumer: TVs and VCRs, Stereo Receivers, CD Players, Cassette Recorders
- Industrial: Small Appliances, Security Systems, Automated Test Equipment, Garage Door Openers



SC-74
CASE 318F
STYLE 7

MARKING DIAGRAM

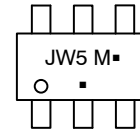

JW5 = Specific Device Code
M = Date Code
▪ = Pb-Free Package
(Note: Microdot may be in either location)

ORDERING INFORMATION

Device	Package	Shipping†
NUD3112DMT1G	SC-74 (Pb-Free)	3000 / Tape & Reel

†For information on tape and reel specifications, including part orientation and tape sizes, please refer to our Tape and Reel Packaging Specifications Brochure, [BRD8011/D](#).

INTERNAL CIRCUIT DIAGRAMS

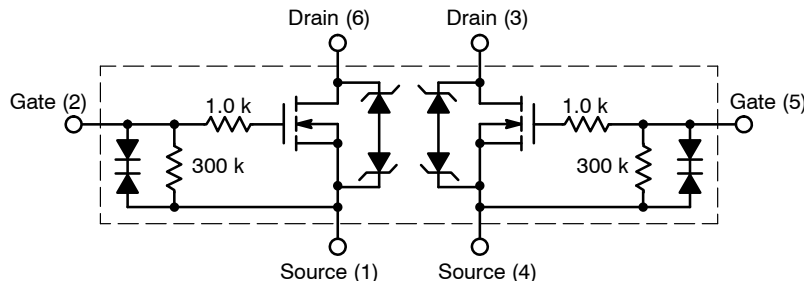

NUD3112

MAXIMUM RATINGS (T_J = 25°C unless otherwise specified)

Symbol	Rating	Value	Unit
V _{DSS}	Drain to Source Voltage – Continuous	14	V _{dc}
V _{GS}	Gate to Source Voltage – Continuous	6	V _{dc}
I _D	Drain Current – Continuous	500	mA
E _z	Single Pulse Drain-to-Source Avalanche Energy (T _{Jinitial} = 25°C)	50	mJ
T _J	Junction Temperature	150	°C
T _A	Operating Ambient Temperature	-40 to 85	°C
T _{stg}	Storage Temperature Range	-65 to +150	°C
P _D	Total Power Dissipation (Note 1) Derating Above 25°C	1.8	mW/°C
P _D	Total Power Dissipation (Note 1) Derating Above 25°C	3.0	mW/°C
R _{θJA}	Thermal Resistance Junction-to-Ambient (Note 1)	329	°C/W
ESD	Human Body Model (HBM) According to EIA/JESD22/A114	2000	V

Stresses exceeding those listed in the Maximum Ratings table may damage the device. If any of these limits are exceeded, device functionality should not be assumed, damage may occur and reliability may be affected.

1. Mounted onto minimum pad board.

TYPICAL ELECTRICAL CHARACTERISTICS (T_A = 25°C unless otherwise noted)

Symbol	Characteristic	Min	Typ	Max	Unit
--------	----------------	-----	-----	-----	------

OFF CHARACTERISTICS

V _{BRDSS}	Drain to Source Sustaining Voltage (Internally Clamped) (I _D = 10 mA)	14	16	17	V
B _{VGS0}	I _g = 1.0 mA	-	-	8	V
I _{DSS}	Drain to Source Leakage Current (V _{DS} = 12 V, V _{GS} = 0 V, T _A = 25°C) (V _{DS} = 12 V, V _{GS} = 0 V, T _A = 85°C)	-	-	20 40	μA
I _{GSS}	Gate Body Leakage Current (V _{GS} = 3.0 V, V _{DS} = 0 V) (V _{GS} = 5.0 V, V _{DS} = 0 V)	-	-	35 65	μA

ON CHARACTERISTICS

V _{GS(th)}	Gate Threshold Voltage (V _{GS} = V _{DS} , I _D = 1.0 mA) (V _{GS} = V _{DS} , I _D = 1.0 mA, T _A = 85°C)	0.8 0.8	1.2 -	1.4 1.4	V
R _{DS(on)}	Drain to Source On-Resistance (I _D = 250 mA, V _{GS} = 3.0 V) (I _D = 500 mA, V _{GS} = 3.0 V) (I _D = 500 mA, V _{GS} = 5.0 V) (I _D = 500 mA, V _{GS} = 3.0 V, T _A = 85°C) (I _D = 500 mA, V _{GS} = 5.0 V, T _A = 85°C)	- - - - -	- - - - -	1.2 1.3 0.9 1.3 0.9	Ω
I _{DS(on)}	Output Continuous Current (V _{DS} = 0.25 V, V _{GS} = 3.0 V) (V _{DS} = 0.25 V, V _{GS} = 3.0 V, T _A = 85°C)	300 200	400 -	- -	mA
g _{FS}	Forward Transconductance (V _{OUT} = 12.0 V, I _{OUT} = 0.25 A)	350	490	-	mmhos

NUD3112

TYPICAL ELECTRICAL CHARACTERISTICS ($T_A = 25^\circ\text{C}$ unless otherwise noted) (continued)

Symbol	Characteristic	Min	Typ	Max	Unit
DYNAMIC CHARACTERISTICS					
C_{iss}	Input Capacitance ($V_{DS} = 12\text{ V}$, $V_{GS} = 0\text{ V}$, $f = 10\text{ kHz}$)	-	23	-	pF
C_{oss}	Output Capacitance ($V_{DS} = 12\text{ V}$, $V_{GS} = 0\text{ V}$, $f = 10\text{ kHz}$)	-	30	-	pF
C_{rss}	Transfer Capacitance ($V_{DS} = 12.0\text{ V}$, $V_{GS} = 0\text{ V}$, $f = 10\text{ kHz}$)	-	7	-	pF

SWITCHING CHARACTERISTICS

Symbol	Characteristic	Min	Typ	Max	Unit
t_{PHL}	Propagation Delay Times: High to Low Propagation Delay; Figure 1 ($V_{DS} = 12\text{ V}$, $V_{GS} = 5.0\text{ V}$) Low to High Propagation Delay; Figure 1 ($V_{DS} = 12\text{ V}$, $V_{GS} = 5.0\text{ V}$)	-	21	-	nS
t_{PLH}		-	91	-	nS
t_f	Transition Times: Fall Time; Figure 1 ($V_{DS} = 12\text{ V}$, $V_{GS} = 5.0\text{ V}$) Rise Time; Figure 1 ($V_{DS} = 12\text{ V}$, $V_{GS} = 5.0\text{ V}$)	-	36	-	nS
t_r		-	61	-	nS

Product parametric performance is indicated in the Electrical Characteristics for the listed test conditions, unless otherwise noted. Product performance may not be indicated by the Electrical Characteristics if operated under different conditions.

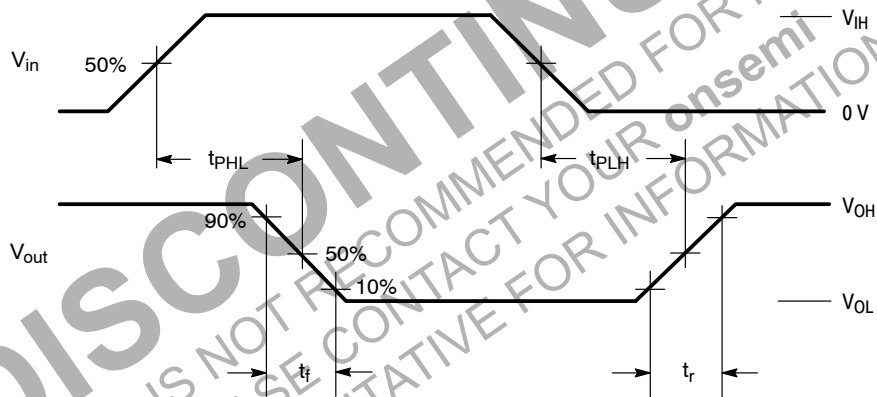

Figure 1. Switching Waveforms

TYPICAL PERFORMANCE CURVES ($T_J = 25^\circ\text{C}$ UNLESS OTHERWISE SPECIFIED)

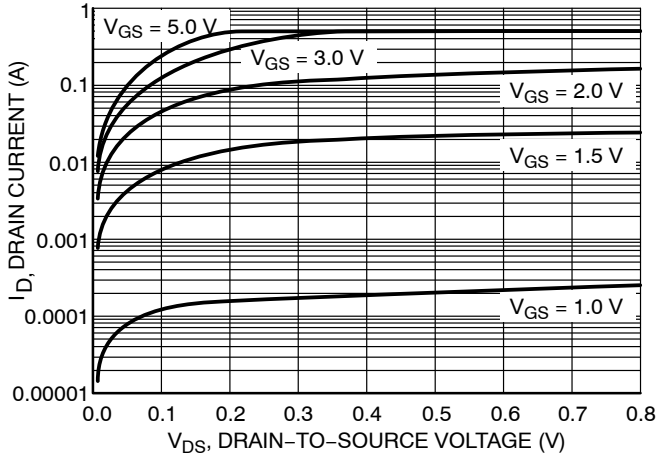

Figure 2. Output Characteristics

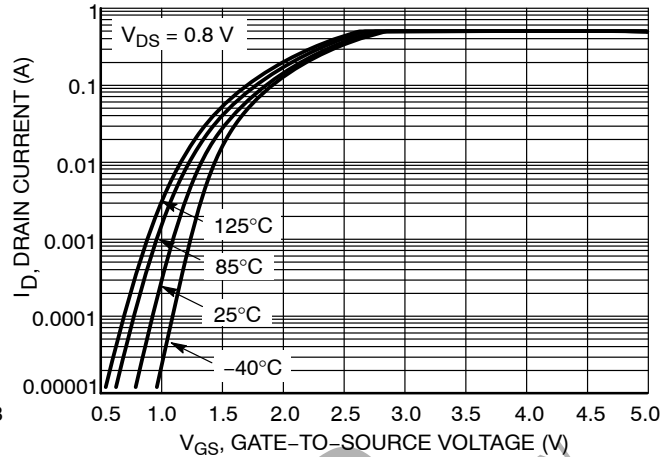

Figure 3. Transfer Function

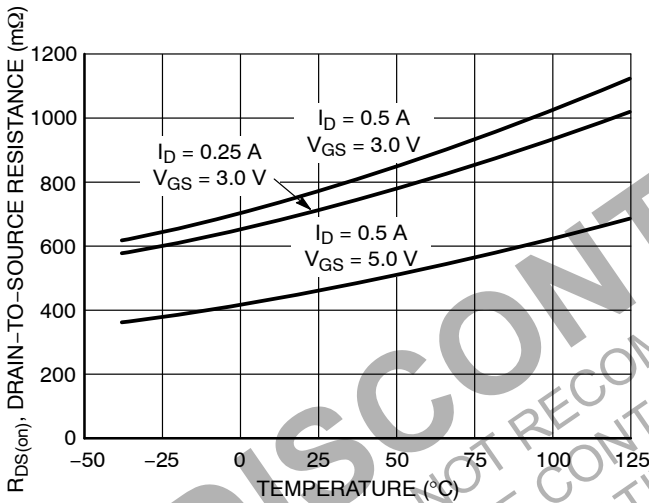

Figure 4. On-Resistance Variation vs. Temperature

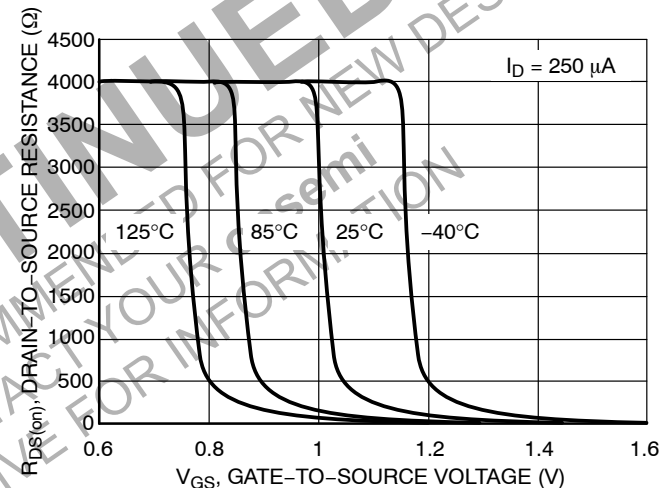

Figure 5. $R_{DS(ON)}$ Variation vs. Gate-to-Source Voltage

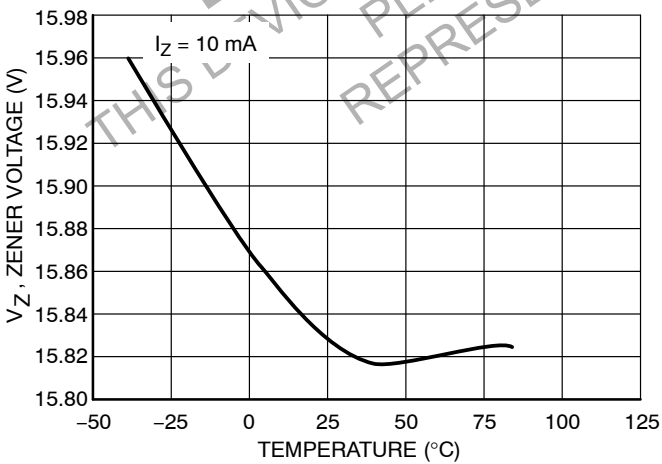

Figure 6. Zener Voltage vs. Temperature

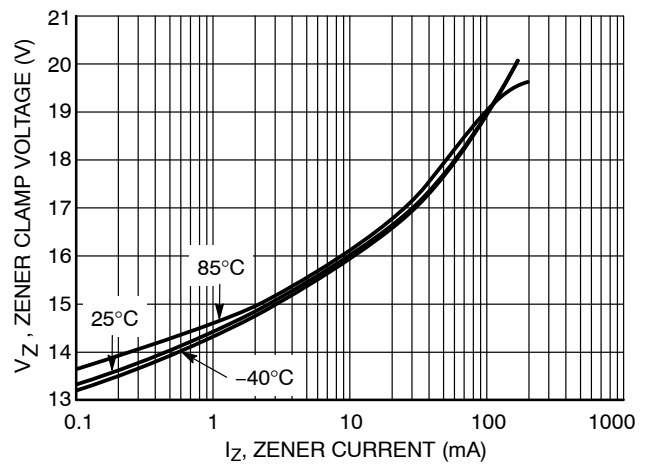

Figure 7. Zener Clamp Voltage vs. Zener Current

NUD3112

TYPICAL PERFORMANCE CURVES ($T_J = 25^\circ\text{C}$ UNLESS OTHERWISE SPECIFIED) (continued)

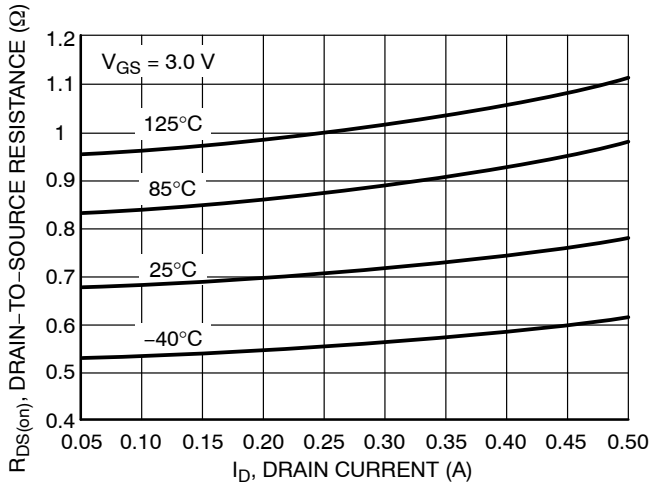

Figure 8. On-Resistance vs. Drain Current and Temperature

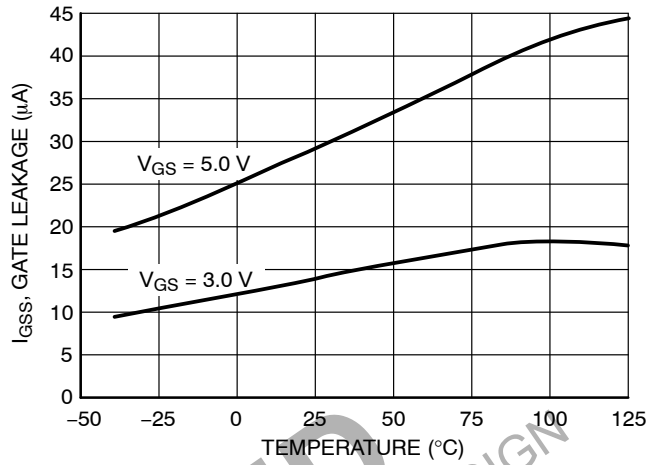

Figure 9. Gate Leakage vs. Temperature

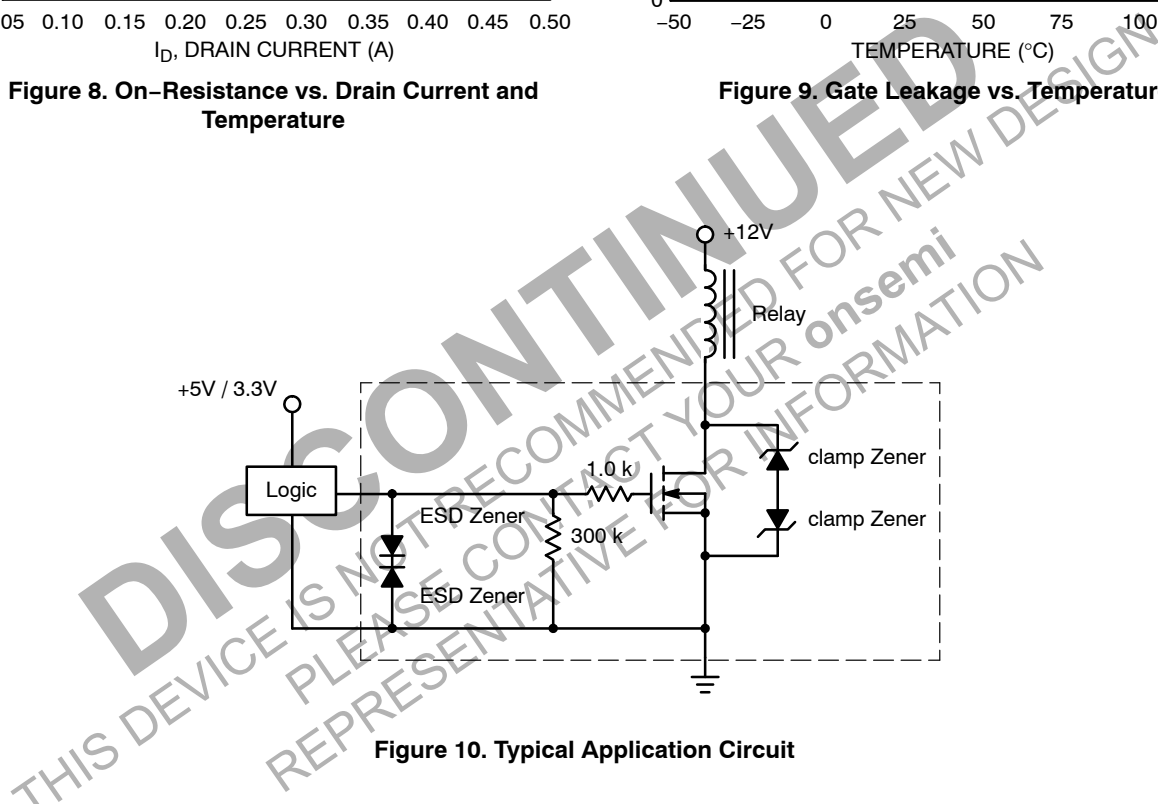

Figure 10. Typical Application Circuit

MECHANICAL CASE OUTLINE PACKAGE DIMENSIONS



SCALE 2:1

SC-74
CASE 318F
ISSUE P

DATE 07 OCT 2021

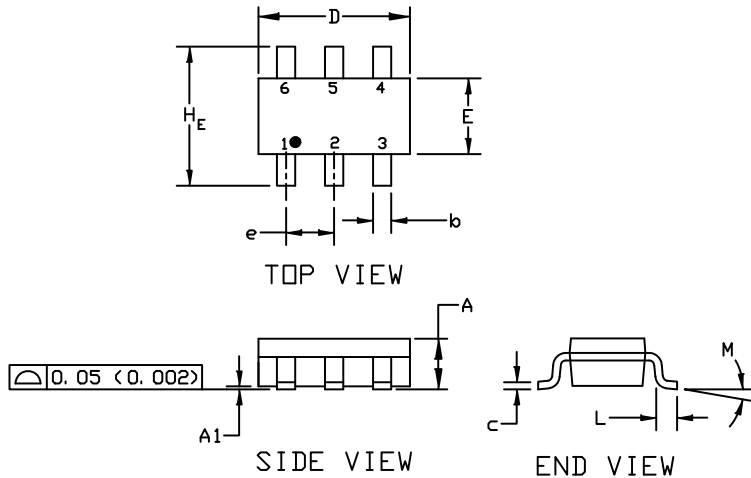

NOTES:

1. DIMENSIONING AND TOLERANCING PER ASME Y14.5M, 1994
2. CONTROLLING DIMENSION: INCHES
3. MAXIMUM LEAD THICKNESS INCLUDES LEAD FINISH THICKNESS. MINIMUM LEAD THICKNESS IS THE MINIMUM THICKNESS OF THE BASE MATERIAL.

DIM	MILLIMETERS			INCHES		
	MIN.	NOM.	MAX.	MIN.	NOM.	MAX.
A	0.90	1.00	1.10	0.035	0.039	0.043
A1	0.01	0.06	0.10	0.001	0.002	0.004
b	0.25	0.37	0.50	0.010	0.015	0.020
c	0.10	0.18	0.26	0.004	0.007	0.010
D	2.90	3.00	3.10	0.114	0.118	0.122
E	1.30	1.50	1.70	0.051	0.059	0.067
e	0.85	0.95	1.05	0.034	0.037	0.041
HE	2.50	2.75	3.00	0.099	0.108	0.118
L	0.20	0.40	0.60	0.008	0.016	0.024
M	0*	---	10*	0*	---	10*

GENERIC MARKING DIAGRAM*

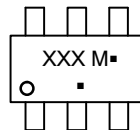

- XXX = Specific Device Code
- M = Date Code
- = Pb-Free Package

(Note: Microdot may be in either location)

*This information is generic. Please refer to device data sheet for actual part marking. Pb-Free indicator, "G" or microdot "▪", may or may not be present. Some products may not follow the Generic Marking.

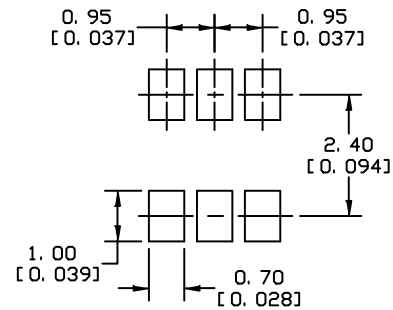

* For additional information on our Pb-Free strategy and soldering details, please download the DN Semiconductor Soldering and Mounting Techniques Reference Manual, SOLDERM/D.

SOLDERING FOOTPRINT

- | | | | | | |
|---|--|---|--|---|---|
| <p>STYLE 1:
PIN 1. CATHODE
2. ANODE
3. CATHODE
4. CATHODE
5. ANODE
6. CATHODE</p> | <p>STYLE 2:
PIN 1. NO CONNECTION
2. COLLECTOR
3. EMITTER
4. NO CONNECTION
5. COLLECTOR
6. BASE</p> | <p>STYLE 3:
PIN 1. EMITTER 1
2. BASE 1
3. COLLECTOR 2
4. EMITTER 2
5. BASE 2
6. COLLECTOR 1</p> | <p>STYLE 4:
PIN 1. COLLECTOR 2
2. EMITTER 1/EMITTER 2
3. COLLECTOR 1
4. EMITTER 3
5. BASE 1/BASE 2/COLLECTOR 3
6. BASE 3</p> | <p>STYLE 5:
PIN 1. CHANNEL 1
2. ANODE
3. CHANNEL 2
4. CHANNEL 3
5. CATHODE
6. CHANNEL 4</p> | <p>STYLE 6:
PIN 1. CATHODE
2. ANODE
3. CATHODE
4. CATHODE
5. CATHODE
6. CATHODE</p> |
| <p>STYLE 7:
PIN 1. SOURCE 1
2. GATE 1
3. DRAIN 2
4. SOURCE 2
5. GATE 2
6. DRAIN 1</p> | <p>STYLE 8:
PIN 1. EMITTER 1
2. BASE 2
3. COLLECTOR 2
4. EMITTER 2
5. BASE 1
6. COLLECTOR 1</p> | <p>STYLE 9:
PIN 1. EMITTER 2
2. BASE 2
3. COLLECTOR 1
4. EMITTER 1
5. BASE 1
6. COLLECTOR 2</p> | <p>STYLE 10:
PIN 1. ANODE/CATHODE
2. BASE
3. EMITTER
4. COLLECTOR
5. ANODE
6. CATHODE</p> | <p>STYLE 11:
PIN 1. EMITTER
2. BASE
3. ANODE/CATHODE
4. ANODE
5. CATHODE
6. COLLECTOR</p> | |

DOCUMENT NUMBER:	98ASB42973B	Electronic versions are uncontrolled except when accessed directly from the Document Repository. Printed versions are uncontrolled except when stamped "CONTROLLED COPY" in red.
DESCRIPTION:	SC-74	PAGE 1 OF 1

onsemi and ONSEMI are trademarks of Semiconductor Components Industries, LLC dba onsemi or its subsidiaries in the United States and/or other countries. onsemi reserves the right to make changes without further notice to any products herein. onsemi makes no warranty, representation or guarantee regarding the suitability of its products for any particular purpose, nor does onsemi assume any liability arising out of the application or use of any product or circuit, and specifically disclaims any and all liability, including without limitation special, consequential or incidental damages. onsemi does not convey any license under its patent rights nor the rights of others.

onsemi, **Onsemi**, and other names, marks, and brands are registered and/or common law trademarks of Semiconductor Components Industries, LLC dba "**onsemi**" or its affiliates and/or subsidiaries in the United States and/or other countries. **onsemi** owns the rights to a number of patents, trademarks, copyrights, trade secrets, and other intellectual property. A listing of **onsemi**'s product/patent coverage may be accessed at www.onsemi.com/site/pdf/Patent-Marking.pdf. **onsemi** reserves the right to make changes at any time to any products or information herein, without notice. The information herein is provided "as-is" and **onsemi** makes no warranty, representation or guarantee regarding the accuracy of the information, product features, availability, functionality, or suitability of its products for any particular purpose, nor does **onsemi** assume any liability arising out of the application or use of any product or circuit, and specifically disclaims any and all liability, including without limitation special, consequential or incidental damages. Buyer is responsible for its products and applications using **onsemi** products, including compliance with all laws, regulations and safety requirements or standards, regardless of any support or applications information provided by **onsemi**. "Typical" parameters which may be provided in **onsemi** data sheets and/or specifications can and do vary in different applications and actual performance may vary over time. All operating parameters, including "Typicals" must be validated for each customer application by customer's technical experts. **onsemi** does not convey any license under any of its intellectual property rights nor the rights of others. **onsemi** products are not designed, intended, or authorized for use as a critical component in life support systems or any FDA Class 3 medical devices or medical devices with a same or similar classification in a foreign jurisdiction or any devices intended for implantation in the human body. Should Buyer purchase or use **onsemi** products for any such unintended or unauthorized application, Buyer shall indemnify and hold **onsemi** and its officers, employees, subsidiaries, affiliates, and distributors harmless against all claims, costs, damages, and expenses, and reasonable attorney fees arising out of, directly or indirectly, any claim of personal injury or death associated with such unintended or unauthorized use, even if such claim alleges that **onsemi** was negligent regarding the design or manufacture of the part. **onsemi** is an Equal Opportunity/Affirmative Action Employer. This literature is subject to all applicable copyright laws and is not for resale in any manner.

ADDITIONAL INFORMATION

TECHNICAL PUBLICATIONS:

Technical Library: www.onsemi.com/design/resources/technical-documentation
onsemi Website: www.onsemi.com

ONLINE SUPPORT: www.onsemi.com/support

For additional information, please contact your local Sales Representative at www.onsemi.com/support/sales

Looking for pricing, stock, or lifecycle information?

Click below to explore more details on WIN SOURCE:

 [View SZNUD3112DMT1G on WIN SOURCE](#)

 [ON Semiconductor](#) Information

Optimize Your Supply Chain with WIN SOURCE Solutions

-  Global Sourcing Solution
-  Obsolete Management
-  Cost Control Management
-  Shortage Management
-  Alternative Solution
-  Excess Inventory Management