



**THE DATASHEET OF  
R574302400**



PAGE 1/2

ISSUE 22-03-22

SERIE : SPnT

PART NUMBER : R574302400

## RF CHARACTERISTICS

Number of ways : **4**  
 Frequency range : **0 - 3 GHz**  
 Impedance : **50 Ohms**

Frequency (GHz)	DC - 3
VSWR max	<b>1.20</b>
Insertion loss max	<b>0.20 dB</b>
Isolation min	<b>80 dB</b>
Average power (*)	<b>240 W</b>

TERMINATION IMPEDANCE : **50 Ohms**  
 TERM. AVG. POWER AT 25° C : **1 W per termination / 3 W total power**

## ELECTRICAL CHARACTERISTICS

Actuator : **NORMALLY OPEN**  
 Nominal current \*\* : **250 mA**  
 Actuator voltage (Vcc) : **12V (10.2 to 13V) / NEGATIVE COMMON**  
 Terminals : **solder pins (250°C max. / 30 sec.)**

## MECHANICAL CHARACTERISTICS

Connectors : **SMA female per MIL-C 39012**  
 Life : **2 million cycles per position**  
 Switching Time\*\*\* : **< 15 ms**  
 Construction : **Splashproof**  
 Weight : **< 250 g**

## ENVIRONMENTAL CHARACTERISTICS

Operating temperature range : **-40°C to +85°C**  
 Storage temperature range : **-55°C to +85°C**

(\* Average power at 25°C per RF Path)  
 (\*\* At 25° C ±10%)  
 (\*\*\*) Nominal voltage ; 25° C)



PAGE 2/2

ISSUE 22-03-22

SERIE : SPnT

PART NUMBER : R574302400

DRAWING

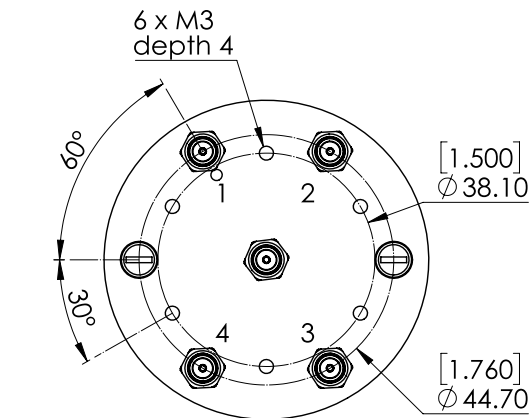

Voltage	RF Continuity
-C +1	IN ↔ 1
-C +2	IN ↔ 2
-C +3	IN ↔ 3
-C +4	IN ↔ 4

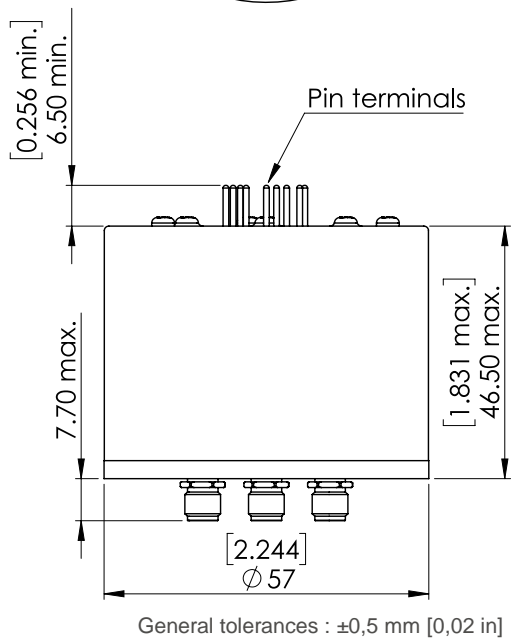

**LABEL**

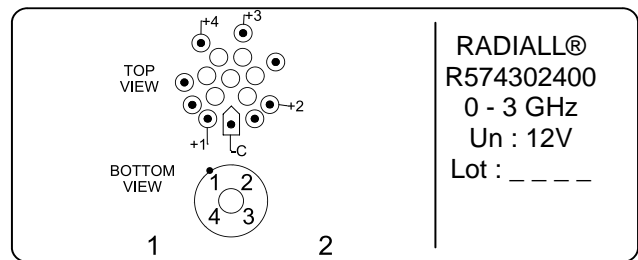

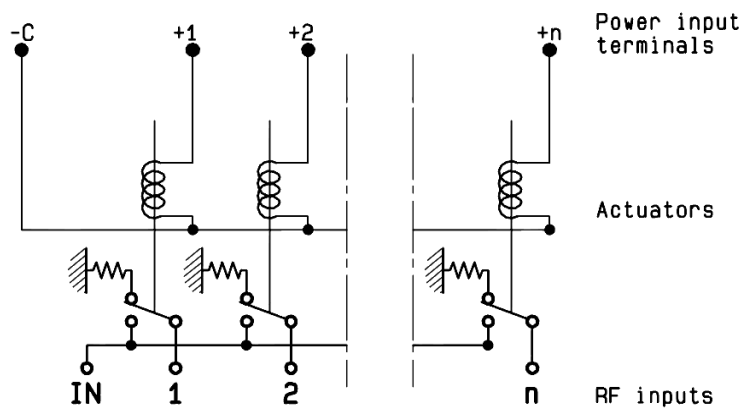

SCHEMATIC DIAGRAM









## Looking for pricing, stock, or lifecycle information?

Click below to explore more details on WIN SOURCE:

-  [View R574302400 on WIN SOURCE](#)
-  [Radiall USA, Inc. Information](#)

## Optimize Your Supply Chain with WIN SOURCE Solutions

-  Global Sourcing Solution
-  Obsolete Management
-  Cost Control Management
-  Shortage Management
-  Alternative Solution
-  Excess Inventory Management