



## Digital Attenuator 30.0 dB, 4-Bit, TTL Driver, DC-2.5 GHz

Rev. V4

### Features

- Attenuation: 2 dB Steps to 30 dB
- Single Positive Supply
- Contains Internal DC to DC Converter
- Integral TTL Driver
- 50 Ohm Impedance
- Test Boards Available
- Tape and Reel Packaging Available
- Lead-Free CSP-1 Package
- 100% Matte Tin Plating over Copper
- Halogen-Free “Green” Mold Compound
- 260°C Reflow Compatible
- RoHS\* Compliant Version of AT90-1233

### Description

M/A-COM's MAAD-007079-000100 is a GaAs FET 4-Bit digital attenuator with integral driver. Step size is 2 dB providing a 30 dB attenuation range. This device is in an FQFP-N plastic surface mount package. The MAAD-007079-000100 is suited for single supply applications where accuracy, fast speed, low power consumption and low costs are required. For dual supply designs without switching noise, use MAATCC0012.

### Ordering Information

Part Number	Package
MAAD-007079-000100	Bulk Packaging
MAAD-007079-0001TR	1000 piece reel
MAAD-007079-0001TB	Sample Test Board

Note: Reference Application Note M513 for reel size information.

\* Restrictions on Hazardous Substances, European Union Directive 2002/95/EC.

### Functional Schematic

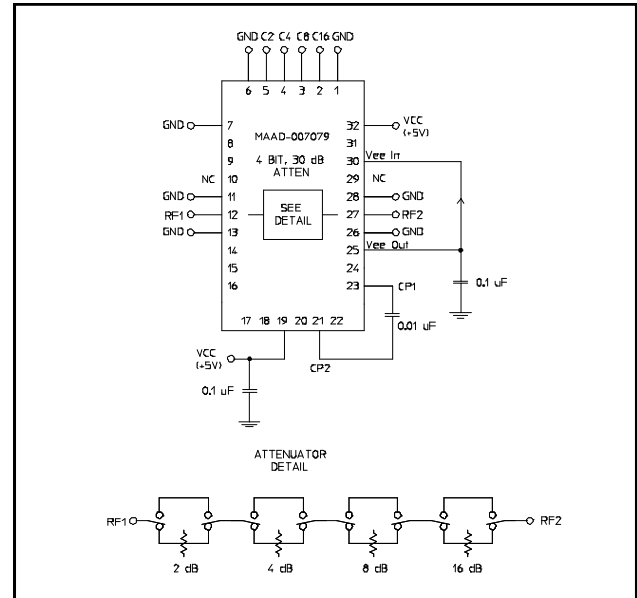

### Pin Configuration<sup>3</sup>

Pin No.	Function	Pin No.	Function
1	GND	17	NC
2	C16	18	NC
3	C8	19	Vcc
4	C4	20	NC
5	C2	21	Cp
6	GND	22	NC
7	GND	23	Cp
8	NC	24	NC
9	NC	25	VEE <sup>2</sup>
10	NC <sup>1</sup>	26	GND
11	GND	27	RF2
12	RF1	28	GND
13	GND	29	NC <sup>1</sup>
14	NC	30	VEE <sup>2</sup>
15	NC	31	NC
16	NC	32	Vcc

1. Pins 10 and 29 must be isolated.
2. VEE is produced internally and requires a .1  $\mu$ F cap to GND. Generated noise is typical of switching DC-DC Converters.
3. The exposed pad centered on the package bottom must be connected to RF and DC ground. (For PQFN Packages)

## Digital Attenuator 30.0 dB, 4-Bit, TTL Driver, DC-2.5 GHz

Rev. V4

### Electrical Specifications: $T_A = 25^\circ\text{C}$ , $Z_0 = 50\Omega$

Parameter	Test Conditions	Frequency	Units	Min	Typ	Max
Insertion Loss	—	DC - 2.5 GHz	dB	—	2.7	3.0
Attenuation Accuracy	Individual Bits or Combination of Bits	DC - 2.5 GHz	dB	—	—	$\pm(,3 + 5\%$ of atten setting)
VSWR	Full Range	DC - 2.5 GHz	Ratio	—	1.5:1	1.8:1
Switching Speed	50% Cntl to 90%/10% RF 10% to 90% or 90% to 10%	— —	nS nS	— —	75 20	150 50
1 dB Compression	— —	50 MHz 0.5 - 2.5 GHz	dBm dBm	— —	+21 +29	— —
Input $IP_3$	Two-tone inputs up to +5 dBm	50 MHz 0.5 - 2.5 GHz	dB dB	— —	+35 +48	— —
$V_{CC}$	—	—	V	4.75	5.0	5.25
$V_{IL}$ $V_{IH}$	LOW-level input voltage HIGH-level input voltage	— —	V V	0.0 2.0	— —	0.8 5.0
$I_{in}$ (Input Leakage Current)	$V_{in} = V_{CC}$ or GND	—	$\mu\text{A}$	-1.0	—	1.0
$I_{CC}^4$	$V_{CC}$ min to max, Logic "0" or "1"	—	mA	—	6	10
Turn-on Current <sup>5</sup>	For guaranteed start-up	—	mA	—	—	125
$\Delta I_{CC}$ (Additional Supply Current Per TTL Input Pin)	$V_{CC} = \text{Max}$ , $V_{cntrl} = V_{CC} - 2.1 \text{ V}$	—	mA	—	—	1.0
Switching Noise	Generated from DC-DC Converter with recommended capacitors	3.5 MHz	dBm	—	-93	—
Thermal Resistance $\theta_{jc}$	—	—	$^\circ\text{C}/\text{W}$	—	15	—

- During turn-on, the device requires an initial start up current ( $I_{CC}$ ) specified as "Turn-on Current". Once operational,  $I_{CC}$  will drop to the specified levels.
- The DC-DC converter is guaranteed to start in 100  $\mu\text{s}$  as long as the power supplies have the maximum turn-on current available for start-up.

### Absolute Maximum Ratings<sup>6,7</sup>

Parameter	Absolute Maximum
Max. Input Power 0.05 GHz 0.5 - 2.5 GHz	+27 dBm +34 dBm
$V_{CC}$	$-0.5\text{V} \leq V_{CC} \leq +6.0\text{V}$
$V_{in}^8$	$-0.5\text{V} \leq V_{in} \leq V_{CC} + 0.5\text{V}$
Operating Temperature	$-40^\circ\text{C}$ to $+85^\circ\text{C}$
Storage Temperature	$-65^\circ\text{C}$ to $+125^\circ\text{C}$

- Exceeding any one or combination of these limits may cause permanent damage to this device.
- M/A-COM does not recommend sustained operation near these survivability limits.
- Standard CMOS TTL interface, latch-up will occur if logic signal is applied prior to power supply.

### Recommended PCB Configuration<sup>9</sup>

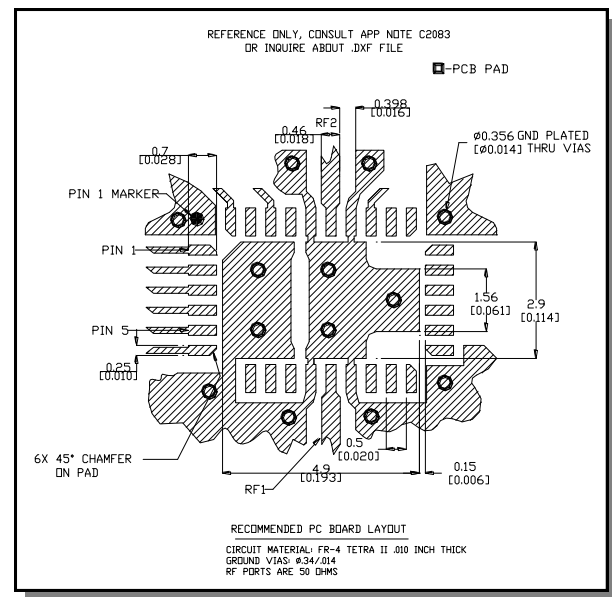

9. Application Note C2083 is available on line at [www.macom.com](http://www.macom.com)

## Handling Procedures

Please observe the following precautions to avoid damage:

### Static Sensitivity

Gallium Arsenide Integrated Circuits are sensitive to electrostatic discharge (ESD) and can be damaged by static electricity. Proper ESD control techniques should be used when handling these devices.

### Moisture Sensitivity

The MSL rating for this part is defined as Level 2 per IPC/JEDEC J-STD-020. Parts shall be stored and/or baked as required for MSL Level 2 parts.

## Truth Table (Digital Attenuator)

C16	C6	C4	C2	Attenuation
0	0	0	0	Loss, Reference
0	0	0	1	2.0 dB
0	0	1	0	4.0 dB
0	1	0	0	8.0 dB
1	0	0	0	16.0 dB
1	1	1	1	30.0 dB

0 = TTL Low; 1 = TTL High

## Typical Performance Curves

### Insertion Loss

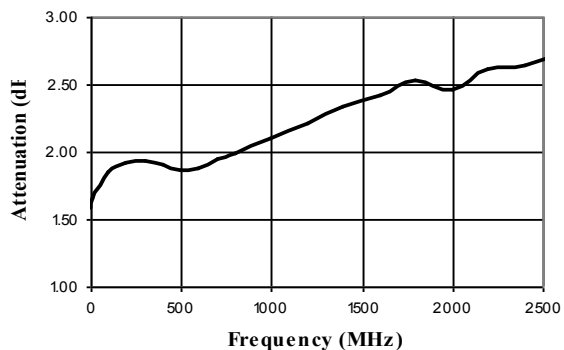

### VSWR @ Insertion Loss

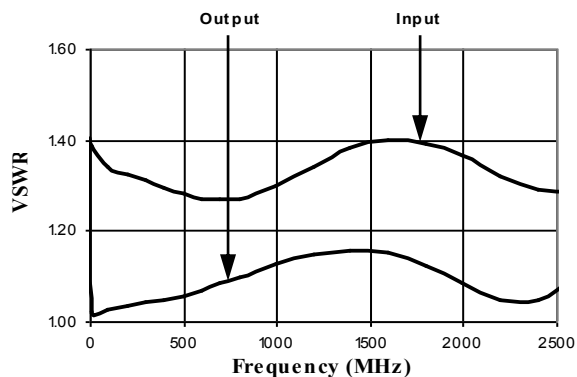

### Attenuation Error, 2 dB Bit

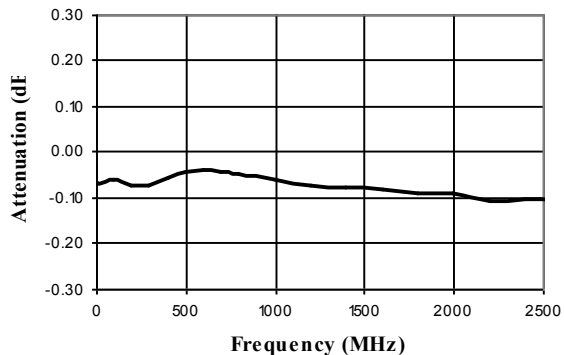

### Attenuation Error, 4 dB Bit

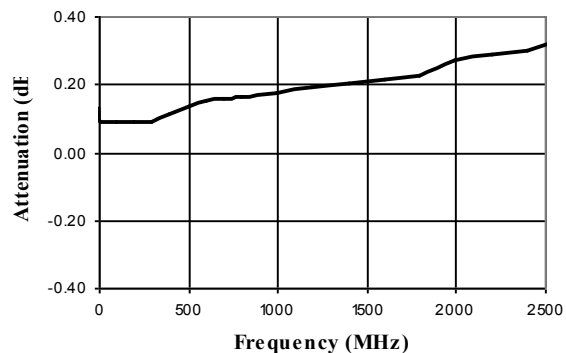

## Typical Performance Curves

*Attenuation Error, 8 dB Bit*

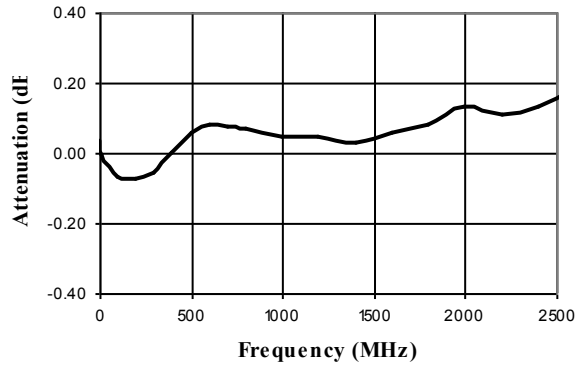

*Attenuation Error, 16 dB Bit*

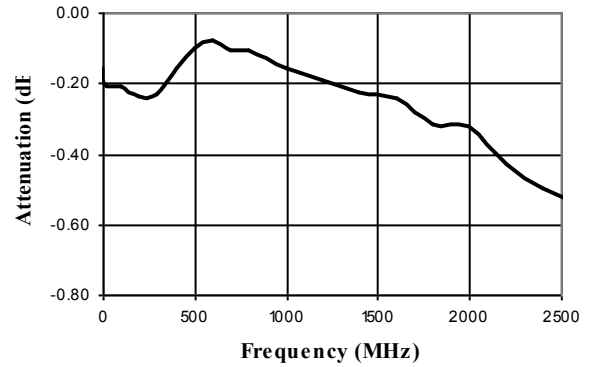

*Attenuation Error, Max. Attenuation*

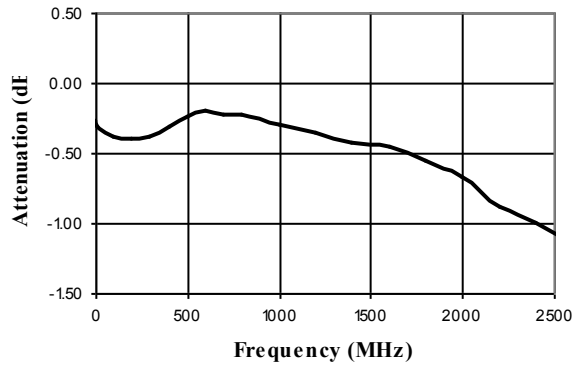

*VSWR, 2 dB Bit*

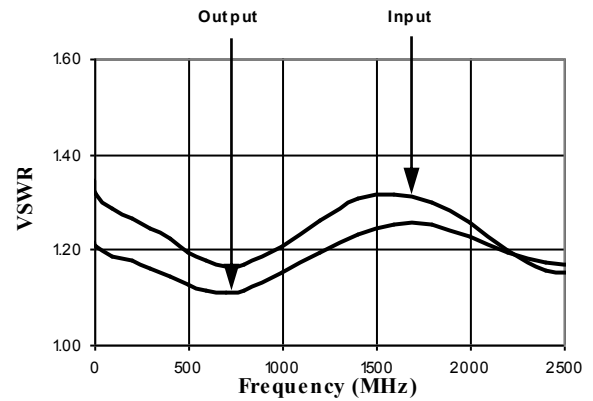

*VSWR, 4 dB Bit*

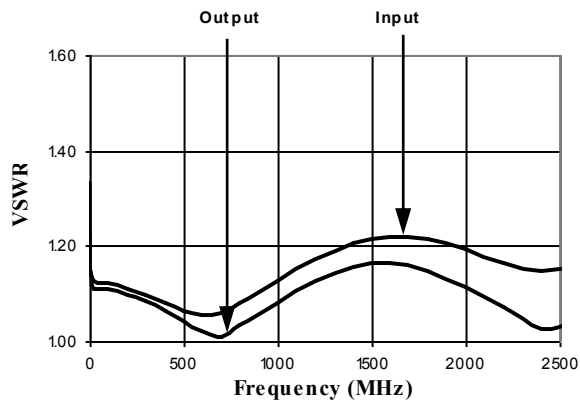

*VSWR, 8 dB Bit*

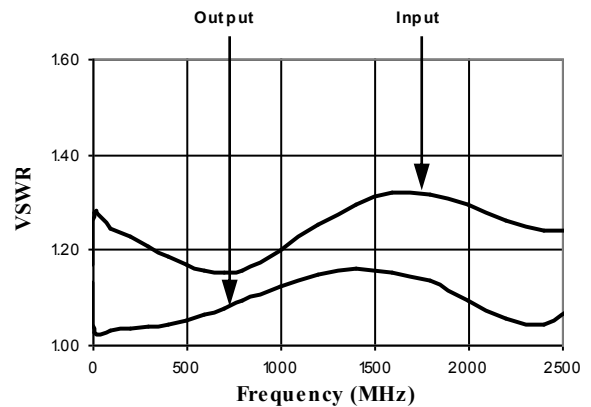

## Digital Attenuator 30.0 dB, 4-Bit, TTL Driver, DC-2.5 GHz

Rev. V4

### Typical Performance Curves

VSWR, 16 dB Bit

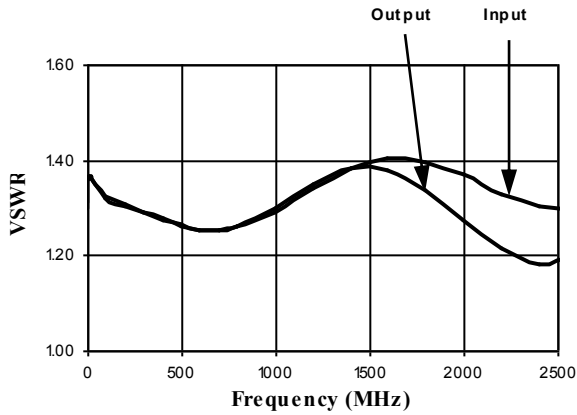

VSWR, Maximum Attenuation

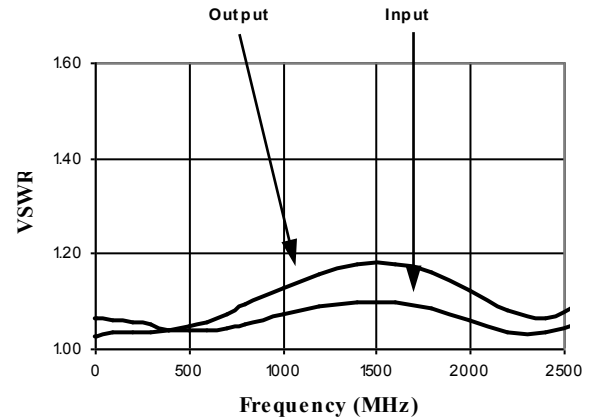

### CSP-1, Lead-Free 4 x 6 mm, 32-lead PQFN<sup>†</sup>

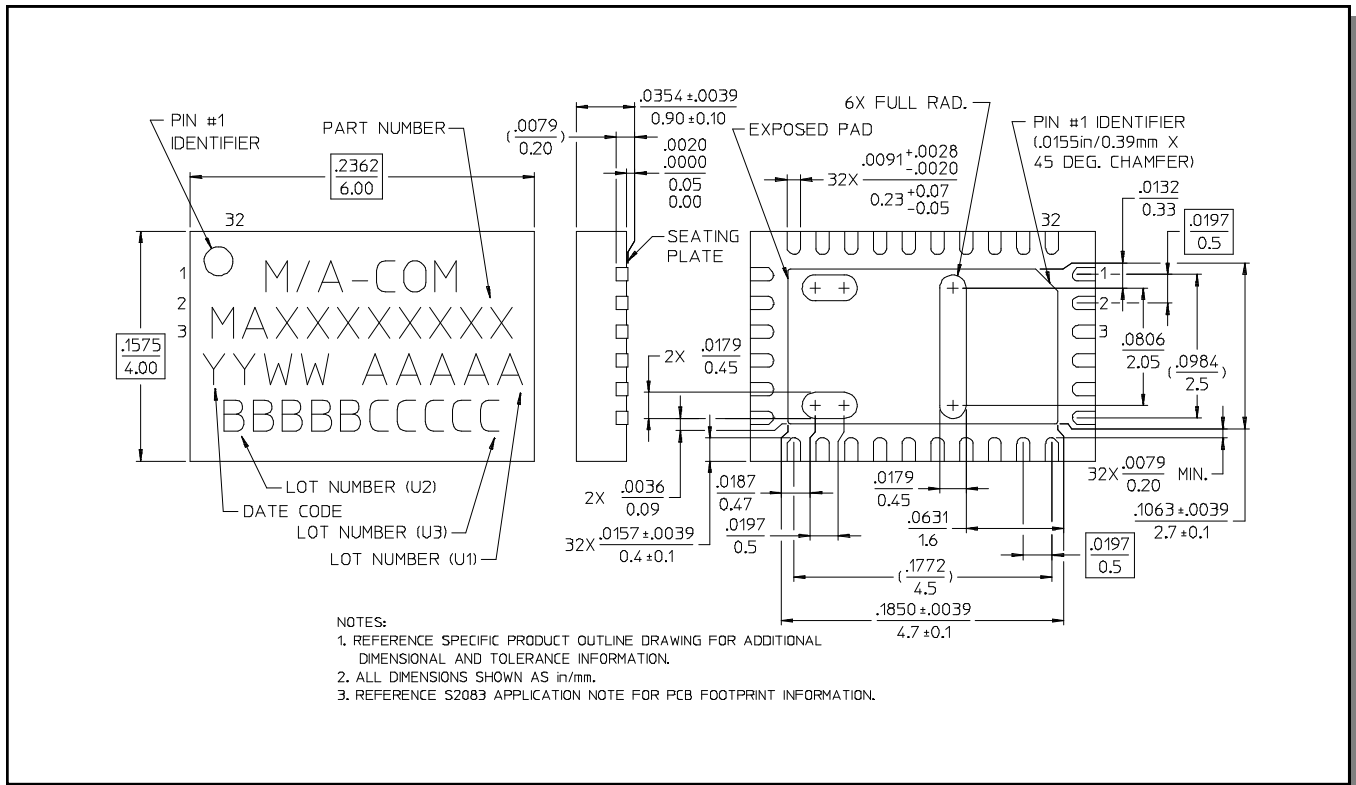

<sup>†</sup> Reference Application Note M538 for lead-free solder reflow recommendations.

M/A-COM Technology Solutions Inc. All rights reserved.

Information in this document is provided in connection with M/A-COM Technology Solutions Inc ("MACOM") products. These materials are provided by MACOM as a service to its customers and may be used for informational purposes only. Except as provided in MACOM's Terms and Conditions of Sale for such products or in any separate agreement related to this document, MACOM assumes no liability whatsoever. MACOM assumes no responsibility for errors or omissions in these materials. MACOM may make changes to specifications and product descriptions at any time, without notice. MACOM makes no commitment to update the information and shall have no responsibility whatsoever for conflicts or incompatibilities arising from future changes to its specifications and product descriptions. No license, express or implied, by estoppel or otherwise, to any intellectual property rights is granted by this document.

THESE MATERIALS ARE PROVIDED "AS IS" WITHOUT WARRANTY OF ANY KIND, EITHER EXPRESS OR IMPLIED, RELATING TO SALE AND/OR USE OF MACOM PRODUCTS INCLUDING LIABILITY OR WARRANTIES RELATING TO FITNESS FOR A PARTICULAR PURPOSE, CONSEQUENTIAL OR INCIDENTAL DAMAGES, MERCHANTABILITY, OR INFRINGEMENT OF ANY PATENT, COPYRIGHT OR OTHER INTELLECTUAL PROPERTY RIGHT. MACOM FURTHER DOES NOT WARRANT THE ACCURACY OR COMPLETENESS OF THE INFORMATION, TEXT, GRAPHICS OR OTHER ITEMS CONTAINED WITHIN THESE MATERIALS. MACOM SHALL NOT BE LIABLE FOR ANY SPECIAL, INDIRECT, INCIDENTAL, OR CONSEQUENTIAL DAMAGES, INCLUDING WITHOUT LIMITATION, LOST REVENUES OR LOST PROFITS, WHICH MAY RESULT FROM THE USE OF THESE MATERIALS.

MACOM products are not intended for use in medical, lifesaving or life sustaining applications. MACOM customers using or selling MACOM products for use in such applications do so at their own risk and agree to fully indemnify MACOM for any damages resulting from such improper use or sale.

6

---

*M/A-COM Technology Solutions Inc. (MACOM) and its affiliates reserve the right to make changes to the product(s) or information contained herein without notice.*  
Visit [www.macom.com](http://www.macom.com) for additional data sheets and product information.

## Looking for pricing, stock, or lifecycle information?

Click below to explore more details on WIN SOURCE:

- ⊖ [View MAAD-007079-000100 on WIN SOURCE](#)
- ⊖ [M/A-Com Technology Solutions Information](#)

## Optimize Your Supply Chain with WIN SOURCE Solutions

- ✓ Global Sourcing Solution
- ✓ Obsolete Management
- ✓ Cost Control Management
- ✓ Shortage Management
- ✓ Alternative Solution
- ✓ Excess Inventory Management