



# THE DATASHEET OF FMM-24R



## 1 Scope

The present specifications shall apply to a FMM-24S/R.

## 2 Outline

Type	Silicon Diode
Structure	Resin Molded
Applications	Commercial Frequency Rectification

## 3 Flammability

UL94V-0(Equivalent)

## 4 Absolute maximum ratings

No.	Item	Symbol	Unit	Rating	Conditions
1	Transient Peak Reverse Voltage	$V_{RSM}$	V	450	
2	Peak Reverse Voltage	$V_{RM}$	V	400	
3	Average Forward Current	$I_{F(AV)}$	A	10	Refer to derating curve in Section 7
4	Peak Surge Forward Current	$I_{FSM}$	A	100	10 ms. Half sine wave, one shot
5	$I^2t$ Limiting Value	$I^2t$	$A^2s$	50	$1\text{ ms} \leq t \leq 10\text{ ms}$
6	Junction Temperature	$T_j$	$^{\circ}C$	-40 to +150	
7	Storage Temperature	$T_{stg}$	$^{\circ}C$	-40 to +150	

No.1, 2, 4 and 5 show ratings per one chip.

5 Electrical characteristics ( $T_a=25^{\circ}C$ , unless otherwise specified)

No.	Item	Symbol	Unit	Value	Conditions
1	Forward Voltage Drop	$V_F$	V	1.1 max.	$I_F=5.0A$
2	Reverse Leakage Current	$I_R$	$\mu A$	10 max.	$V_R=V_{RM}$
3	Reverse Leakage Current Under High Temperature	$H \cdot I_R$	$\mu A$	100 max.	$V_R=V_{RM}, T_j=150^{\circ}C$
4	Thermal Resistance	$R_{th(j-c)}$	$^{\circ}C/W$	4.0 max.	Between Junction and case

No.1, 2 and 3 show characteristics per one chip.

6 Characteristics

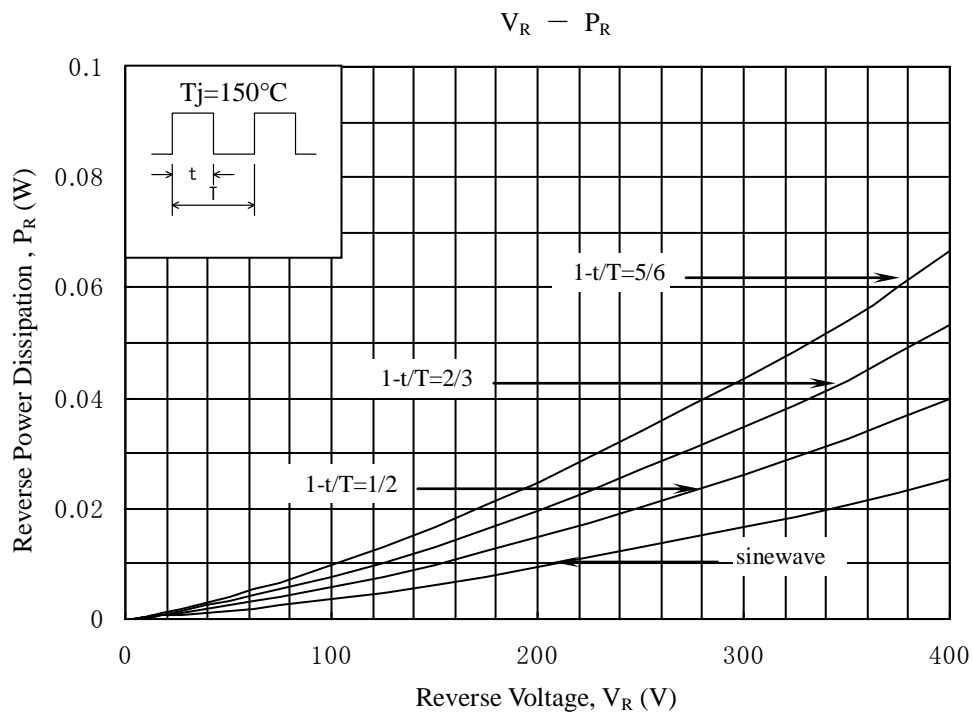
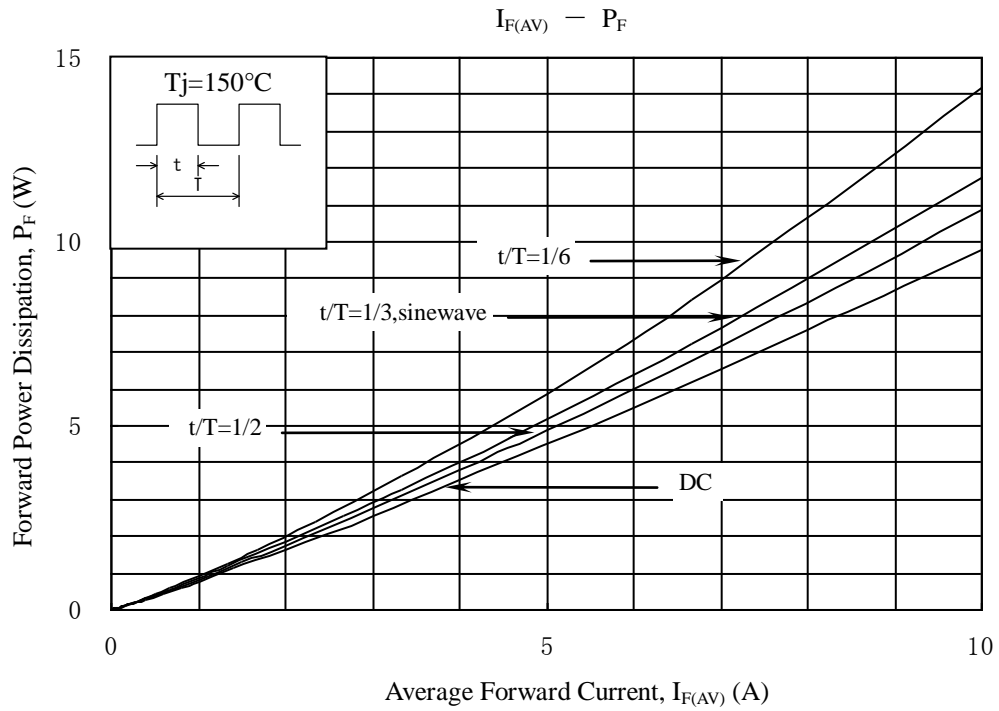

7 Derating

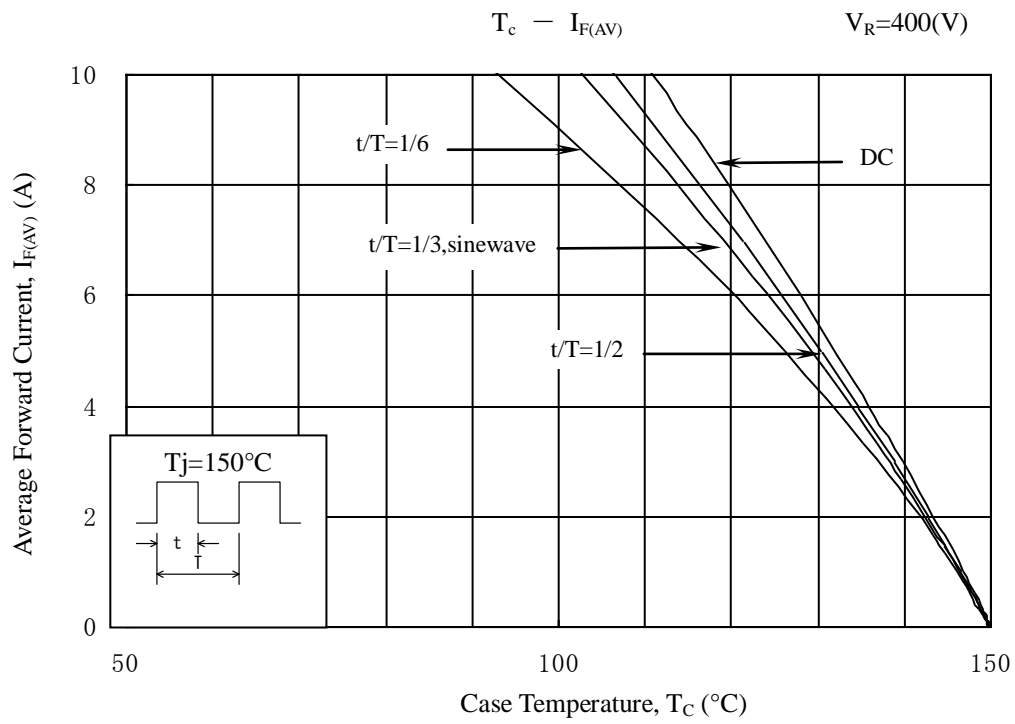

8 Package information

8-1 Package type, physical dimensions and material

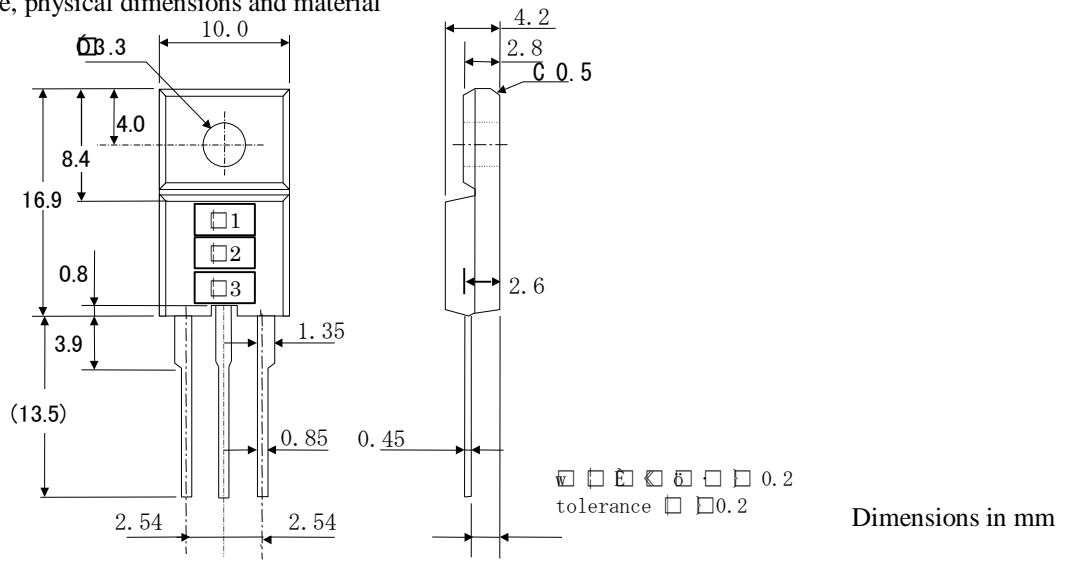

8-2 Appearance



The body shall be clean and shall not bear any stain, rust or flaw.

8-3 Marking







Type Name	Marking		
	*1 is type name	*2 is polarity	*3 is lot number
FMM-24S	FMM24S		1st letter: Last digit of year 2nd letter: Month From 1 to 9 for Jan. to Sep., O for Oct., N for Nov., D for Dec. 3rd & 4th letter: Day ex. 2117 (Jan. 17, 2002)
FMM-24R	FMM24R		

## Looking for pricing, stock, or lifecycle information?

Click below to explore more details on WIN SOURCE:

-  [View FMM-24R on WIN SOURCE](#)
-  [Sanken Information](#)

## Optimize Your Supply Chain with WIN SOURCE Solutions

-  Global Sourcing Solution
-  Obsolete Management
-  Cost Control Management
-  Shortage Management
-  Alternative Solution
-  Excess Inventory Management