



**THE DATASHEET OF  
RF316-13GP1-01SP1-1000**



**DESIGNED & DIMENSIONED  
IN MILLIMETERS [INCHES]**

**THIS PRODUCT MANUFACTURED  
WITH LEAD-FREE PROCESSING**

DO NOT  
SCALE FROM  
THIS PRINT

RFXXXX-XXXXX-XXXXXX-XXXX

**CABLE CALL OUT**  
174: CCA-174 (RG-174 COAXIAL CABLE)  
316: CCA-316 (RG-316 COAXIAL CABLE)  
□ 316A: CCS-174525-01-C (RG-316 ACCLIMATE CABLE)

**OVERALL CABLE LENGTH**  
MILLIMETERS OF CABLE  
0100 MIN. (SEE NOTE 8 & 9)

**FIG 2**  
CABLE STRIPPING DIMENSIONS  
PER CONFIGURATIONS  
(SEE TABLE 1) (SEE NOTES 12,13,14,15)

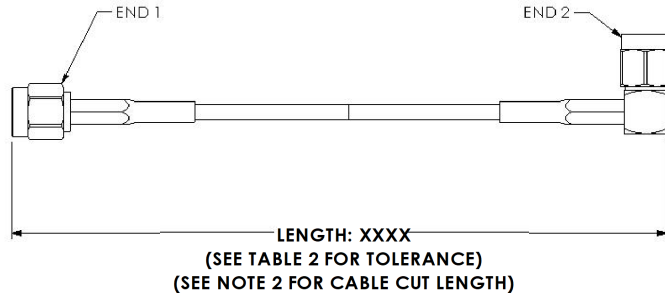
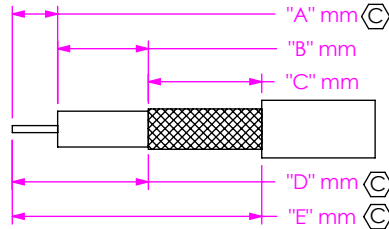

**FIG 1**  
RFXXX-01SPX-01RPX-XXXX SHOWN

- END 1 CONNECTOR**
- 01SP: SMA-P-C-X-ST-CA1 (SEE SHEET 3)
  - 01RP: SMA-P-C-X-RA-CA1 (SEE SHEET 3)
  - 01BJ: SMA-J-C-X-ST-BH1 (SEE SHEET 3)
  - 01BR: SMA-J-C-X-ST-BR1 (SEE SHEET 3)
  - 02SJ: MCX-J-C-X-ST-CA1 (SEE SHEET 3)
  - 02RP: MCX-P-C-XX-RA-CA1 (SEE SHEET 3)
  - 02SP: MCX-P-C-XX-ST-CA1 (SEE SHEET 4)
  - 03SP: MMCX-P-C-XX-ST-CA1 (SEE SHEET 4)
  - 03RP: MMCX-P-C-X-RA-CA1 (SEE SHEET 4)
  - 04SP: BNC5-P-C-XX-ST-CA1 (SEE SHEET 4)
  - 04BJ: BNC5-J-C-XX-ST-BH1 (SEE SHEET 4)
  - 05SP: TNC-P-C-XX-ST-CA1 (SEE SHEET 4)
  - 05BJ: TNC-J-C-XX-ST-BH1 (SEE SHEET 5)
  - 06BJ: NTPE-J-C-XX-ST-BH1 (SEE SHEET 5)
  - 07SP: SMB5-P-C-XX-ST-CA1 (SEE SHEET 5)
  - 07RP: SMB5-P-C-XX-RA-CA1 (SEE SHEET 5)
  - 07BJ: SMB5-J-C-X-ST-BH1 (SEE SHEET 5)
  - 13GP: GRFS-P-C-X-ST-CA1 (316 OPTION ONLY) (SEE SHEET 5)
  - 13GJ: GRFS-J-C-X-ST-CA1 (316 OPTION ONLY) (SEE SHEET 6)
  - 01SB: SMA-J-C-X-ST-SB1 (SEE SHEET 6)
  - 01SR: SMA-J-C-X-ST-SR1 (SEE SHEET 6)
  - 01PN: SMA-J-C4-XX-ST-PN1 (SEE SHEET 6)
  - \*-S7SP: SSMB-P-C-XX-ST-CA1 (SEE SHEET 7)
  - V3SJ: MMCXV-J-C-XX-ST-CA1 (SEE SHEET 7)
  - V3SP: MMCXV-P-C-XX-ST-CA1 (SEE SHEET 7)
  - V3RP: MMCXV-P-C-XX-RA-CA1 (SEE SHEET 7)
  - -23GJ: AC-J-C-X-ST-CA1 (316A OPTION ONLY, SEE SHEET 7)
  - -23GP: AC-P-C-X-ST-CA1 (316A OPTION ONLY, SEE SHEET 7)

- END 1 PLATING OPTION**
- 1: GOLD ALL COMPONENTS
  - 2: GOLD / NICKEL COMBINATION
  - 3: ALTERNATE GOLD / NICKEL
  - 4: ALTERNATE GOLD / GOLD FLASH / NICKEL
  - 7: ALTERNATE GOLD MEDIUM/ GOLD FLASH (SEE SHEET 3 FOR PLATING SPECIFICS)

- = FOR INTERNAL USE ONLY, NOT FOR SALE (SEE NOTE 19)
- \* = FOR EXISTING CUSTOMERS ONLY

- END 2 PLATING OPTION**
- 1: GOLD ALL COMPONENTS
  - 2: GOLD / NICKEL COMBINATION
  - 3: ALTERNATE GOLD / NICKEL
  - 4: ALTERNATE GOLD / GOLD FLASH / NICKEL
  - 7: ALTERNATE GOLD MEDIUM/ GOLD FLASH (LEAVE BLANK FOR -SING OR -XXXXXX END 2 PREPARATION)

- END 2 CONNECTOR OR PREPARATION**
- 01SP: SMA-P-C-X-ST-CA1 (SEE SHEET 3)
  - 01RP: SMA-P-C-X-RA-CA1 (SEE SHEET 3)
  - 01BJ: SMA-J-C-X-ST-BH1 (SEE SHEET 3)
  - 01BR: SMA-J-C-X-ST-BR1 (SEE SHEET 3)
  - 02SJ: MCX-J-C-X-ST-CA1 (SEE SHEET 3)
  - 02RP: MCX-P-C-XX-RA-CA1 (SEE SHEET 3)
  - 02SP: MCX-P-C-XX-ST-CA1 (SEE SHEET 4)
  - 03SP: MMCX-P-C-XX-ST-CA1 (SEE SHEET 4)
  - 03RP: MMCX-P-C-X-RA-CA1 (SEE SHEET 4)
  - 04SP: BNC5-P-C-XX-ST-CA1 (SEE SHEET 4)
  - 04BJ: BNC5-J-C-XX-ST-BH1 (SEE SHEET 4)
  - 05SP: TNC-P-C-XX-ST-CA1 (SEE SHEET 4)
  - 05BJ: TNC-J-C-XX-ST-BH1 (SEE SHEET 5)
  - 06BJ: NTPE-J-C-XX-ST-BH1 (SEE SHEET 5)
  - 07SP: SMB5-P-C-XX-ST-CA1 (SEE SHEET 5)
  - 07RP: SMB5-P-C-XX-RA-CA1 (SEE SHEET 5)
  - 07BJ: SMB5-J-C-X-ST-BH1 (SEE SHEET 5)
  - 13GP: GRFS-P-C-X-ST-CA1 (316 OPTION ONLY) (SEE SHEET 5)
  - 13GJ: GRFS-J-C-X-ST-CA1 (316 OPTION ONLY) (SEE SHEET 6)
  - 01SB: SMA-J-C-X-ST-SB1 (SEE SHEET 6)
  - 01SR: SMA-J-C-X-ST-SR1 (SEE SHEET 6)
  - 01PN: SMA-J-C4-XX-ST-PN1 (SEE SHEET 6)
  - S7SP: SSMB-P-C-XX-ST-CA1 (SEE SHEET 7)
  - V3SJ: MMCXV-J-C-XX-ST-CA1 (SEE SHEET 7)
  - V3SP: MMCXV-P-C-XX-ST-CA1 (SEE SHEET 7)
  - V3RP: MMCXV-P-C-XX-RA-CA1 (SEE SHEET 7)
  - -23GJ: AC-J-C-X-ST-CA1 (316A OPTION ONLY, SEE SHEET 7)
  - -23GP: AC-P-C-X-ST-CA1 (316A OPTION ONLY, SEE SHEET 7)
  - SING: SINGLE ENDED (ONE END ONLY, SEE NOTE 11)
  - XXXXXX: STRIPPED AND TINNED (THIS END ONLY- SEE NOTES 11-15, 18 & SHEET 6, FIG 3)

(SEE FIG 2) "C" FORMAT: X.X mm  
(SEE FIG 2) "B" FORMAT: X.X mm  
(SEE FIG 2) "A" FORMAT: X.X mm

DO NOT LEAVE ANY SPACE BLANK,  
EACH MUST CONTAIN A  
NUMERIC CHARACTER 0 THRU 9.

- NOTES:
1. Ⓢ REPRESENTS A CRITICAL DIMENSION.
  2. CABLE CUT LENGTH:  
= (LENGTH: XXXX) - (SUBTRACTOR FOR END 1) - (SUBTRACTOR FOR END 2).  
(SEE TABLE 1 FOR SUBTRACTORS)
  - Ⓢ 3. ASSEMBLY TO BE 100% TESTED FOR OPENS & SHORTS.
  - Ⓢ 4. ASSEMBLY TO BE 100% HI-POT TESTED PER TABLE 1, THE TEST VOLTAGE FOR THE ASSEMBLY SHOULD BE SET TO THE END OPTION WITH THE LOWEST TEST VOLTAGE RATING.
  5. AFTER FINAL ELECTRICAL TESTS, LABEL EACH CABLE ASSEMBLY WITH 1 LABEL -ET
  6. CRITICALS ON CONNECTOR PRINTS TO BE CHECKED IN PROCESS.
  7. FINISHED ASSEMBLIES TO BE PACKAGED PER PACKAGING STANDARD CO-RF-WI-3040-M. ASSEMBLIES WITH LOCKWASHERS, NUTS, AND GASKETS TO BE SHIPPED KITTED AS ONE ASSEMBLY PER BAG, UNASSEMBLED.
  8. CABLE STOCKED IN INCHES, 1 INCH = 25.4 MILLIMETERS.
  9. CABLE LENGTHS LONGER THAN 1000 MILLIMETERS ARE NOT SUPPORTED BY S.I. TEST DATA.
  10. MINIMUM BEND RADIUS FOR RF174 = 25.4 [1.00]  
RF316 = 12.7 [.50]  
RF316A = 12.7 [.50]
  11. FOR SING ENDED OR STRIPPED AND TINNED ASSEMBLIES: MAKE A DOUBLE ENDED ASSEMBLY AT TWICE THE CABLE LENGTH AND TEST BEFORE CUTTING ASSEMBLY IN HALF.
  12. DIM "A", "B", AND "C" HAVE A MINIMUM VALUE OF 0.0mm & A MAXIMUM VALUE OF 9.9mm.
  13. PRODUCTION OF STRIP AND TIN FOR CENTER DIELECTIC USE: A.
  14. PRODUCTION OF STRIP AND TIN FOR SHIELD USE: D=A+B.
  15. PRODUCTION OF STRIP AND TIN FOR JACKET USE: E=A+B+C.
  16. CONNECTORS TO BE ORIENTED ACCORDING TO CO-HD-WI-3048-M.
  17. FOR BULKHEAD APPLICATIONS, THE END USER SHOULD TIGHTEN THE THREADED NUT TO 15 IN-LB MINIMUM.
  18. FOR STRIPPED AND TINNED OPTION, ONLY THE CENTER CONDUCTOR IS TINNED.
  19. USED IN ACRX SERIES.

c:\enterprisvault\DWG\MISC\MKTG\RFXXXX-XXXXX-XXXXXX-MKT.SLDDRW

UNLESS OTHERWISE SPECIFIED, DIMENSIONS ARE IN MILLIMETERS [INCHES]. TOLERANCES ARE: DECIMALS ANGLES .X: ±0.3 [.01] 2° .XX: ±0.13 [.005] .XXX: ±0.051 [.0020]	PROPRIETARY NOTE THIS DOCUMENT CONTAINS CONFIDENTIAL AND PROPRIETARY INFORMATION AND ALL DESIGN, MANUFACTURING, REPRODUCTION, USE, PATENT RIGHTS AND SALES RIGHTS ARE EXPRESSLY RESERVED BY SAMTEC, INC. THIS DOCUMENT SHALL NOT BE DISCLOSED, IN WHOLE OR PART, TO ANY UNAUTHORIZED PERSON OR ENTITY NOR REPRODUCED, TRANSFERRED OR INCORPORATED IN ANY OTHER PROJECT IN ANY MANNER WITHOUT THE EXPRESS WRITTEN CONSENT OF SAMTEC, INC.
MATERIAL: DO NOT SCALE DRAWING SEE END 1 AND END 2 ASSEMBLY PRINTS	SHEET SCALE: 2:1

<b>samtec</b>	
520 PARK EAST BLVD, NEW ALBANY, IN 47150 PHONE: 812-944-6733 FAX: 812-948-5047 e-Mail info@SAMTEC.com code 55322	
DESCRIPTION: RF316 OR RF-174 CABLE ASSEMBLY	
DWG. NO. RFXXXX-XXXXX-XXXXXX-XXXX	
BY: TIM P.	09-10-2010 SHEET 1 OF 7

TABLE 1		
CABLE	CABLE CUT LGTH	HI-POT
STYLE	"SUBTRACTOR"	DCV
-01SPX	5.7 [0.22]	1000
-01RPX	2.7 [0.11]	1000
-01BJX	9.0 [0.35]	1000
-01BRX	9.4 [0.37]	1000
-02SJX	6.2 [0.24]	1000
-02RPX	1.7 [0.07]	1000
-02SPX	7.4 [0.29]	630
-03SPX	4.2 [0.17]	1000
-03RPX	1.4 [0.06]	1000
-04SPX	9.0 [0.35]	1000
-04BJX	13.4 [0.53]	1000
-05SPX	9.3 [0.37]	1000
-05BJX	13.4 [0.53]	1000
-06BJX	17.0 [0.67]	1000
-07SPX	7.7 [0.30]	1000
-07RPX	2.8 [0.11]	1000
-07BJX	8.4 [0.33]	1000
-13GPX	5.1 [0.20]	1000
-13GJX	4.2 [0.16]	1000
-01SBX	9.0 [0.35]	1000
-01SRX	9.4 [0.37]	1000
-01PNX	6.2 [0.24]	1000
*-S7SPX	8.1 [0.32]	1000
-V3SJX	4.9 [0.19]	1000
-V3SPX	5.7 [0.22]	1000
-V3RPX	1.5 [0.06]	1000
-23GJX	4.4 [0.17]	300
□ -23GPX	5.3 [0.21]	300
□ -SING	0.00 [0.00]	1000
-XXXXXX	0.00 [0.00]	1000

□ = FOR INTERNAL USE ONLY, NOT FOR SALE (SEE NOTE 19)  
 \* = FOR EXISTING CUSTOMERS ONLY

TABLE 2: FINAL ASSEMBLY LENGTH TOLERANCE	
LENGTH	TOLERANCE
0100-0200 [3.92-7.87]	+3.0 [.12]/-0.0 [.00]
0200-0500 [7.87-19.69]	+5.0 [.20]/-0.0 [.00]
0500-1100 [19.69-43.30]	+10.0 [.40]/-0.0 [.00]
>1100 [43.30]	± 1%

c:\enterprisevault\DWG\MISC\MKTG\RFXXXX-XXXX-XXXX-XXXX-MKT.SLDDRW

**PROPRIETARY NOTE**  
 THIS DOCUMENT CONTAINS CONFIDENTIAL AND PROPRIETARY INFORMATION AND ALL DESIGN, MANUFACTURING, REPRODUCTION, USE, PATENT RIGHTS AND SALES RIGHTS ARE EXPRESSLY RESERVED BY SAMTEC, INC. THIS DOCUMENT SHALL NOT BE DISCLOSED, IN WHOLE OR PART, TO ANY UNAUTHORIZED PERSON OR ENTITY NOR REPRODUCED, TRANSFERRED OR INCORPORATED IN ANY OTHER PROJECT IN ANY MANNER WITHOUT THE EXPRESS WRITTEN CONSENT OF SAMTEC, INC.

DO NOT SCALE DRAWING

SHEET SCALE: 1:1



520 PARK EAST BLVD, NEW ALBANY, IN 47150  
 PHONE: 812-944-6733 FAX: 812-948-5047  
 e-Mail info@SAMTEC.com code 55322

DESCRIPTION:  
 RF316 OR RF-174 CABLE ASSEMBLY

DWG. NO.  
**RFXXXX-XXXX-XXXXXX-XXXX**

BY: TIM P. 09-10-2010 SHEET 2 OF 7

**-01SP**  
(STRAIGHT PLUG)

(USE DRAWING No. SMA-P-C-X-ST-CA1  
FOR ASSEMBLY INSTRUCTIONS)

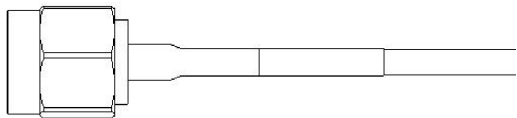

PLATING  
1: 30µ" MIN. GOLD CENTER CONTACT  
3µ" MIN. GOLD OUTER CONTACT  
3µ" MIN. GOLD REMAINING METAL PARTS  
(END CONNECTOR P/N: SMA-P-C-H-ST-CA1)

NOTE: ALL CRITICAL DIMENSIONS ON SMA-P-C-X-ST-CA1  
THAT APPLY MUST BE VERIFIED.

**-01RP**  
(RIGHT ANGLE PLUG)

(USE DRAWING No. SMA-P-C-X-RA-CA1  
FOR ASSEMBLY INSTRUCTIONS)

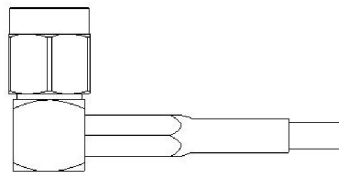

PLATING  
1: 30µ" MIN. GOLD CENTER CONTACT  
3µ" MIN. GOLD OUTER CONTACT  
3µ" MIN. GOLD REMAINING METAL PARTS  
(END CONNECTOR P/N: SMA-P-C-H-RA-CA1)

NOTE: ALL CRITICAL DIMENSIONS ON SMA-P-C-X-RA-CA1  
THAT APPLY MUST BE VERIFIED.

**-01BJ**  
(STRAIGHT BULKHEAD JACK)  
(SEE NOTE 17)

(USE DRAWING No. SMA-J-C-X-ST-BH1  
FOR ASSEMBLY INSTRUCTIONS)

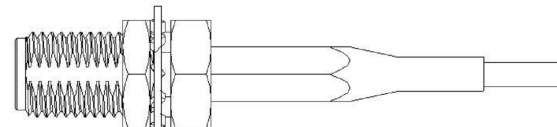

PLATING  
1: 30µ" MIN. GOLD CENTER CONTACT  
3µ" MIN. GOLD OUTER CONTACT  
3µ" MIN. GOLD REMAINING METAL PARTS  
(END CONNECTOR P/N: SMA-J-C-H-ST-BH1)

NOTE: ALL CRITICAL DIMENSIONS ON SMA-J-C-X-ST-BH1  
THAT APPLY MUST BE VERIFIED.

**-01BR (REVERSED POLARITY)**  
(STRAIGHT BULKHEAD JACK)  
(SEE NOTE 17)

(USE DRAWING No. SMA-J-C-X-ST-BR1  
FOR ASSEMBLY INSTRUCTIONS)

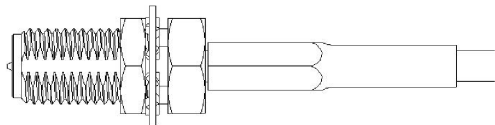

PLATING  
1: 30µ" MIN. GOLD CENTER CONTACT  
3µ" MIN. GOLD OUTER CONTACT  
3µ" MIN. GOLD REMAINING METAL PARTS  
(END CONNECTOR P/N: SMA-J-C-H-ST-BR1)

NOTE: ALL CRITICAL DIMENSIONS ON SMA-J-C-X-ST-BR1  
THAT APPLY MUST BE VERIFIED.

**-02SJ**  
(STRAIGHT JACK)

(USE DRAWING No. MCX-J-C-X-ST-CA1  
FOR ASSEMBLY INSTRUCTIONS)

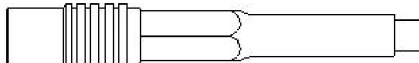

PLATING  
1: 30µ" MIN. GOLD CENTER CONTACT  
3µ" MIN. GOLD OUTER CONTACT  
3µ" MIN. GOLD REMAINING METAL PARTS  
(END CONNECTOR P/N: MCX-J-C-H-ST-CA1)

NOTE: ALL CRITICAL DIMENSIONS ON MCX-J-C-X-ST-CA1  
THAT APPLY MUST BE VERIFIED.

**-02RP**  
(RIGHT ANGLE PLUG)

(USE DRAWING No. MCX-P-C-XX-RA-CA1  
FOR ASSEMBLY INSTRUCTIONS)

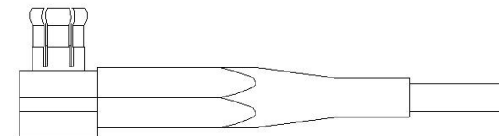

PLATING  
1: 30µ" MIN. GOLD CENTER CONTACT  
3µ" MIN. GOLD OUTER CONTACT  
3µ" MIN. GOLD REMAINING METAL PARTS  
(END CONNECTOR P/N: MCX-P-C-H-RA-CA1)

NOTE: ALL CRITICAL DIMENSIONS ON MCX-P-C-XX-RA-CA1  
THAT APPLY MUST BE VERIFIED.

c:\enterprisevault\DWG\MISC\MKTG\RFXXXX-XXXX-XXXX-XXXX-MKT.SLDDRW

**PROPRIETARY NOTE**  
THIS DOCUMENT CONTAINS CONFIDENTIAL AND PROPRIETARY INFORMATION AND ALL DESIGN, MANUFACTURING, REPRODUCTION, USE, PATENT RIGHTS AND SALES RIGHTS ARE EXPRESSLY RESERVED BY SAMTEC, INC. THIS DOCUMENT SHALL NOT BE DISCLOSED, IN WHOLE OR PART, TO ANY UNAUTHORIZED PERSON OR ENTITY NOR REPRODUCED, TRANSFERRED OR INCORPORATED IN ANY OTHER PROJECT IN ANY MANNER WITHOUT THE EXPRESS WRITTEN CONSENT OF SAMTEC, INC.

DO NOT SCALE DRAWING

SHEET SCALE: 1:1



520 PARK EAST BLVD, NEW ALBANY, IN 47150  
PHONE: 812-944-6733 FAX: 812-948-5047  
e-Mail info@SAMTEC.com code 55322

DESCRIPTION:  
RF316 OR RF-174 CABLE ASSEMBLY

DWG. NO.  
RFXXXX-XXXX-XXXXXX-XXXX

BY: TIM P. 09-10-2010 SHEET 3 OF 7

**-02SP**  
(STRAIGHT PLUG)

(USE DRAWING No. MCX-P-C-XX-ST-CA1 FOR ASSEMBLY INSTRUCTIONS)



PLATING  
1: 30µ" MIN. GOLD CENTER CONTACT  
3µ" MIN. GOLD OUTER CONTACT  
3µ" MIN. GOLD REMAINING METAL PARTS  
(END CONNECTOR P/N: MCX-P-C-H-ST-CA1)

NOTE: ALL CRITICAL DIMENSIONS ON MCX-P-C-XX-ST-CA1 THAT APPLY MUST BE VERIFIED.

**-03SP**  
(STRAIGHT PLUG)

(USE DRAWING No. MMCX-P-C-XX-ST-CA1 FOR ASSEMBLY INSTRUCTIONS)



PLATING  
1: 30µ" MIN. GOLD CENTER CONTACT  
3µ" MIN. GOLD OUTER CONTACT  
3µ" MIN. GOLD REMAINING METAL PARTS  
(END CONNECTOR P/N: MMCX-P-C-H-ST-CA1)

NOTE: ALL CRITICAL DIMENSIONS ON MMCX-P-C-XX-ST-CA1 THAT APPLY MUST BE VERIFIED.

**-03RP**  
(RIGHT ANGLE PLUG)

(USE DRAWING No. MMCX-P-C-X-RA-CA1 FOR ASSEMBLY INSTRUCTIONS)

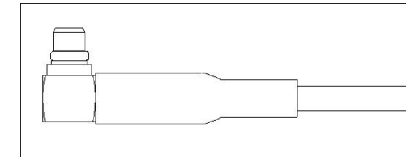

PLATING  
1: 30µ" MIN. GOLD CENTER CONTACT  
3µ" MIN. GOLD OUTER CONTACT  
3µ" MIN. GOLD REMAINING METAL PARTS  
(END CONNECTOR P/N: MMCX-P-C-H-RA-CA1)

NOTE: ALL CRITICAL DIMENSIONS ON MMCX-P-C-X-RA-CA1 THAT APPLY MUST BE VERIFIED.

**-04SP**  
(STRAIGHT PLUG)

(USE DRAWING No. BNC5-P-C-XX-ST-CA1 FOR ASSEMBLY INSTRUCTIONS)

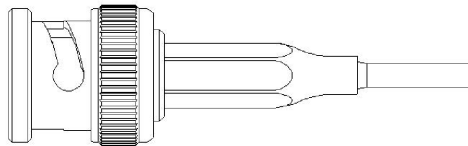

PLATING OPTIONS  
2: 30µ" MIN. GOLD CENTER CONTACT  
100µ" MIN. NICKEL OUTER CONTACT  
100µ" MIN. NICKEL REMAINING METAL PARTS  
(END CONNECTOR P/N: BNC5-P-C-HN-ST-CA1)  
3: 10µ" MIN. GOLD CENTER CONTACT  
100µ" MIN. NICKEL OUTER CONTACT  
100µ" MIN. NICKEL REMAINING METAL PARTS  
(END CONNECTOR P/N: BNC5-P-C-GN-ST-CA1)

NOTE: ALL CRITICAL DIMENSIONS ON BNC5-P-C-XX-ST-CA1 THAT APPLY MUST BE VERIFIED.

**-04BJ**  
(STRAIGHT BULKHEAD JACK)  
(SEE NOTE 17)

(USE DRAWING No. BNC5-J-C-XX-ST-BH1 FOR ASSEMBLY INSTRUCTIONS)

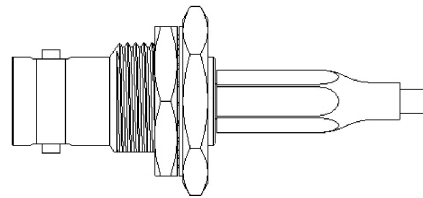

PLATING OPTIONS  
2: 30µ" MIN. GOLD CENTER CONTACT  
100µ" MIN. NICKEL OUTER CONTACT  
100µ" MIN. NICKEL REMAINING METAL PARTS  
(END CONNECTOR P/N: BNC5-J-C-HN-ST-BH1)  
3: 10µ" MIN. GOLD CENTER CONTACT  
100µ" MIN. NICKEL OUTER CONTACT  
100µ" MIN. NICKEL REMAINING METAL PARTS  
(END CONNECTOR P/N: BNC5-J-C-GN-ST-BH1)

NOTE: ALL CRITICAL DIMENSIONS ON BNC5-J-C-XX-ST-BH1 THAT APPLY MUST BE VERIFIED.

**-05SP**  
(STRAIGHT PLUG)

(USE DRAWING No. TNC-P-C-XX-ST-CA1 FOR ASSEMBLY INSTRUCTIONS)

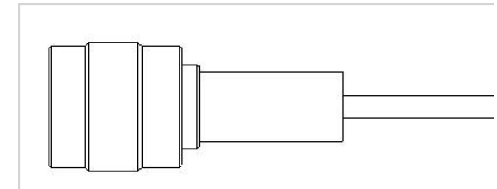

PLATING  
3: 10µ" MIN. GOLD CENTER CONTACT  
100µ" MIN. NICKEL OUTER CONTACT  
100µ" MIN. NICKEL REMAINING METAL PARTS  
(END CONNECTOR P/N: TNC-P-C-GN-ST-CA1)

NOTE: ALL CRITICAL DIMENSIONS ON TNC-P-C-XX-ST-CA1 THAT APPLY MUST BE VERIFIED.

**PROPRIETARY NOTE**  
THIS DOCUMENT CONTAINS CONFIDENTIAL AND PROPRIETARY INFORMATION AND ALL DESIGN, MANUFACTURING, REPRODUCTION, USE, PATENT RIGHTS AND SALES RIGHTS ARE EXPRESSLY RESERVED BY SAMTEC, INC. THIS DOCUMENT SHALL NOT BE DISCLOSED, IN WHOLE OR PART, TO ANY UNAUTHORIZED PERSON OR ENTITY NOR REPRODUCED, TRANSFERRED OR INCORPORATED IN ANY OTHER PROJECT IN ANY MANNER WITHOUT THE EXPRESS WRITTEN CONSENT OF SAMTEC, INC.

DO NOT SCALE DRAWING

SHEET SCALE: 1:1



520 PARK EAST BLVD, NEW ALBANY, IN 47150  
PHONE: 812-944-6733 FAX: 812-948-5047  
e-Mail info@SAMTEC.com code 55322

DESCRIPTION:  
RF316 OR RF-174 CABLE ASSEMBLY

DWG. NO.  
RFXXXX-XXXXX-XXXXXX-XXXX

BY: TIM P. 09-10-2010 SHEET 4 OF 7

REVISION AP

**-05BJ**  
(STRAIGHT BULKHEAD JACK)  
(SEE NOTE 17)

(USE DRAWING No. TNC-J-C-XX-ST-BH1  
FOR ASSEMBLY INSTRUCTIONS)

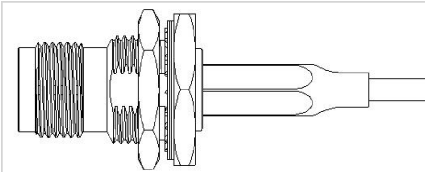

**PLATING OPTIONS**

2: 30µ" MIN. GOLD CENTER CONTACT  
100µ" MIN. NICKEL OUTER CONTACT  
100µ" MIN. NICKEL REMAINING METAL PARTS  
(END CONNECTOR P/N: TNC-J-C-HN-ST-BH1)

3: 10µ" MIN. GOLD CENTER CONTACT  
100µ" MIN. NICKEL OUTER CONTACT  
100µ" MIN. NICKEL REMAINING METAL PARTS  
(END CONNECTOR P/N: TNC-J-C-GN-ST-BH1)

NOTE: ALL CRITICAL DIMENSIONS ON TNC-J-C-XX-ST-BH1  
THAT APPLY MUST BE VERIFIED.

**-06BJ**  
(STRAIGHT BULKHEAD JACK)  
(SEE NOTE 17)

(USE DRAWING No. NTPE-J-C-XX-ST-BH1  
FOR ASSEMBLY INSTRUCTIONS)

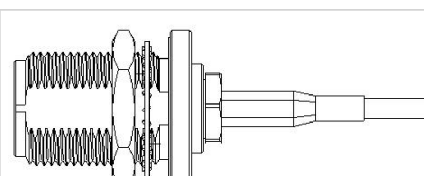

**PLATING**

2: 30µ" MIN. GOLD CENTER CONTACT  
100µ" MIN. NICKEL OUTER CONTACT  
100µ" MIN. NICKEL REMAINING METAL PARTS  
(END CONNECTOR P/N: NTPE-J-C-HN-ST-BH1)

NOTE: ALL CRITICAL DIMENSIONS ON NTPE-J-C-XX-ST-BH1  
THAT APPLY MUST BE VERIFIED.

**-07SP**  
(STRAIGHT PLUG)

(USE DRAWING No. SMB5-P-C-XX-ST-CA1  
FOR ASSEMBLY INSTRUCTIONS)

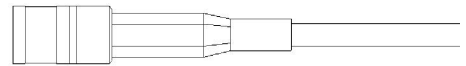

**PLATING**

1: 30µ" MIN. GOLD CENTER CONTACT  
3µ" MIN. GOLD OUTER CONTACT  
3µ" MIN. GOLD REMAINING METAL PARTS  
(END CONNECTOR P/N: SMB5-P-C-H-ST-CA1)

NOTE: ALL CRITICAL DIMENSIONS ON SMB5-P-C-XX-ST-CA1  
THAT APPLY MUST BE VERIFIED.

**-07RP**  
(RIGHT ANGLE PLUG)

(USE DRAWING No. SMB5-P-C-XX-RA-CA1  
FOR ASSEMBLY INSTRUCTIONS)

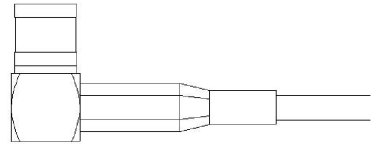

**PLATING**

1: 30µ" MIN. GOLD CENTER CONTACT  
3µ" MIN. GOLD OUTER CONTACT  
3µ" MIN. GOLD REMAINING METAL PARTS  
(END CONNECTOR P/N: SMB5-P-C-H-RA-CA1)

NOTE: ALL CRITICAL DIMENSIONS ON SMB5-P-C-XX-RA-CA1  
THAT APPLY MUST BE VERIFIED.

**-07BJ**  
(STRAIGHT BULKHEAD JACK)  
(SEE NOTE 17)

(USE DRAWING No. SMB5-J-C-X-ST-BH1  
FOR ASSEMBLY INSTRUCTIONS)

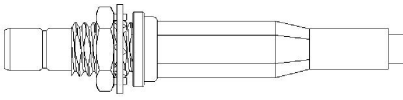

**PLATING**

1: 30µ" MIN. GOLD CENTER CONTACT  
3µ" MIN. GOLD OUTER CONTACT  
3µ" MIN. GOLD REMAINING METAL PARTS  
(END CONNECTOR P/N: SMB5-J-C-H-ST-BH1)

NOTE: ALL CRITICAL DIMENSIONS ON SMB5-J-C-X-ST-BH1  
THAT APPLY MUST BE VERIFIED.

**-13GP**  
(STRAIGHT PLUG)

(USE DRAWING No. GRFS-P-C-X-ST-CA1  
FOR ASSEMBLY INSTRUCTIONS)  
(316 OPTION ONLY)



**PLATING**

1: 30µ" MIN. GOLD CENTER CONTACT  
3µ" MIN. GOLD OUTER CONTACT  
3µ" MIN. GOLD REMAINING METAL PARTS  
(END CONNECTOR P/N: GRFS-P-C-H-ST-CA1)

NOTE: ALL CRITICAL DIMENSIONS ON GRFS-P-C-X-ST-CA1  
THAT APPLY MUST BE VERIFIED.

c:\enterprisevault\DWG\MISC\MKTG\RFXXXX-XXXX-XXXX-XXXX-MKT.SLDDRW

**PROPRIETARY NOTE**

THIS DOCUMENT CONTAINS CONFIDENTIAL AND PROPRIETARY INFORMATION AND ALL DESIGN, MANUFACTURING, REPRODUCTION, USE, PATENT RIGHTS AND SALES RIGHTS ARE EXPRESSLY RESERVED BY SAMTEC, INC. THIS DOCUMENT SHALL NOT BE DISCLOSED, IN WHOLE OR PART, TO ANY UNAUTHORIZED PERSON OR ENTITY NOR REPRODUCED, TRANSFERRED OR INCORPORATED IN ANY OTHER PROJECT IN ANY MANNER WITHOUT THE EXPRESS WRITTEN CONSENT OF SAMTEC, INC.

DO NOT SCALE DRAWING

SHEET SCALE: 1:1



520 PARK EAST BLVD, NEW ALBANY, IN 47150  
PHONE: 812-944-6733 FAX: 812-948-5047  
e-Mail info@SAMTEC.com code 55322

DESCRIPTION:  
RF316 OR RF-174 CABLE ASSEMBLY

DWG. NO.  
RFXXXX-XXXXX-XXXXXX-XXXX

BY: TIM P. 09-10-2010 SHEET 5 OF 7

**-13GJ**  
(STRAIGHT JACK)

(USE DRAWING No. GRFS-J-C-X-ST-CA1  
FOR ASSEMBLY INSTRUCTIONS)  
(316 OPTION ONLY)

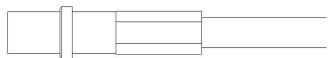

**PLATING**  
1: 30µ" MIN. GOLD CENTER CONTACT  
3µ" MIN. GOLD OUTER CONTACT  
3µ" MIN. GOLD REMAINING METAL PARTS  
(END CONNECTOR P/N: GRFS-J-C-H-ST-CA1)

NOTE: ALL CRITICAL DIMENSIONS ON GRFS-J-C-X-ST-CA1  
THAT APPLY MUST BE VERIFIED.

**-01SB**  
(SEALED STRAIGHT BULKHEAD JACK)  
(SEE NOTE 17)

(USE DRAWING No. SMA-J-C-X-ST-SB1  
FOR ASSEMBLY INSTRUCTIONS)

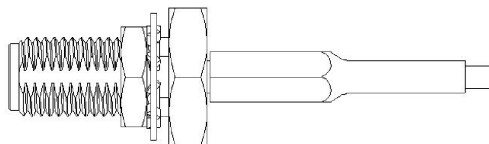

**PLATING**  
1: 30µ" MIN. GOLD CENTER CONTACT  
3µ" MIN. GOLD OUTER CONTACT  
3µ" MIN. GOLD REMAINING METAL PARTS  
(END CONNECTOR P/N: SMA-J-C-H-ST-SB1)

NOTE: ALL CRITICAL DIMENSIONS ON SMA-J-C-X-ST-SB1  
THAT APPLY MUST BE VERIFIED.

**-01SR (REVERSED POLARITY)**  
(SEALED STRAIGHT BULKHEAD JACK)  
(SEE NOTE 17)

(USE DRAWING No. SMA-J-C-X-ST-SR1  
FOR ASSEMBLY INSTRUCTIONS)

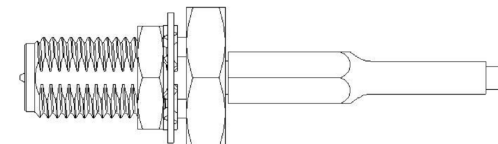

**PLATING**  
1: 30µ" MIN. GOLD CENTER CONTACT  
3µ" MIN. GOLD OUTER CONTACT  
3µ" MIN. GOLD REMAINING METAL PARTS  
(END CONNECTOR P/N: SMA-J-C-H-ST-SR1)

NOTE: ALL CRITICAL DIMENSIONS ON SMA-J-C-X-ST-SR1  
THAT APPLY MUST BE VERIFIED.

**-01PN**  
(STRAIGHT PANEL MOUNT JACK)

(USE DRAWING No. SMA-J-C4-XX-ST-PN1  
FOR ASSEMBLY INSTRUCTIONS)

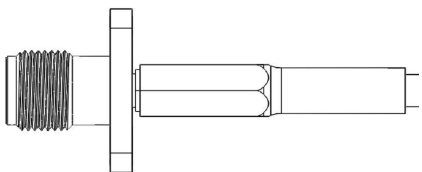

**PLATING**  
1: 30µ" MIN. GOLD CENTER CONTACT  
3µ" MIN. GOLD OUTER CONTACT  
3µ" MIN. GOLD REMAINING METAL PARTS  
(END CONNECTOR P/N: SMA-J-C4-H-ST-PN1)

NOTE: ALL CRITICAL DIMENSIONS ON SMA-J-C4-XX-ST-PN1  
THAT APPLY MUST BE VERIFIED.

**FIG 3**  
RFXXX-04BJX-102148-XXXX SHOWN

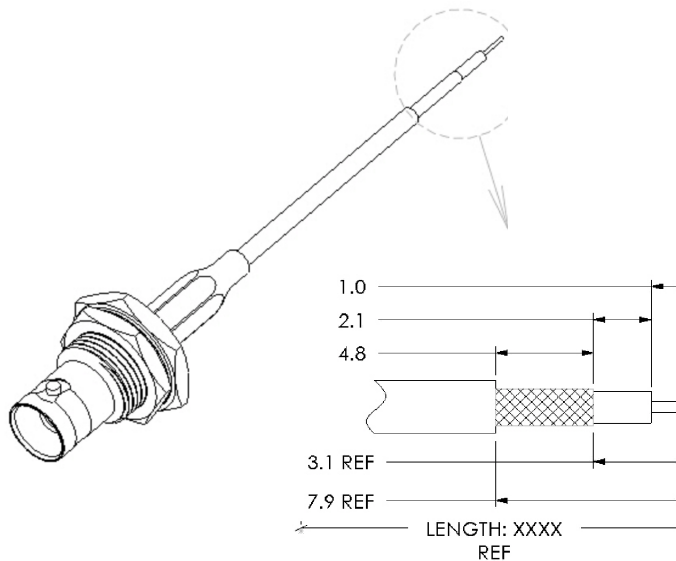

c:\enterprisevault\DWG\MISC\MKTG\RFXXX-XXXX-XXXX-XXXX-MKT.SLDDRW

**PROPRIETARY NOTE**  
THIS DOCUMENT CONTAINS CONFIDENTIAL AND PROPRIETARY INFORMATION AND ALL DESIGN, MANUFACTURING, REPRODUCTION, USE, PATENT RIGHTS AND SALES RIGHTS ARE EXPRESSLY RESERVED BY SAMTEC, INC. THIS DOCUMENT SHALL NOT BE DISCLOSED, IN WHOLE OR PART, TO ANY UNAUTHORIZED PERSON OR ENTITY NOR REPRODUCED, TRANSFERRED OR INCORPORATED IN ANY OTHER PROJECT IN ANY MANNER WITHOUT THE EXPRESS WRITTEN CONSENT OF SAMTEC, INC.

DO NOT SCALE DRAWING

SHEET SCALE: 1:1



520 PARK EAST BLVD, NEW ALBANY, IN 47150  
PHONE: 812-944-6733 FAX: 812-948-5047  
e-Mail info@SAMTEC.com code 55322

DESCRIPTION:  
RF316 OR RF-174 CABLE ASSEMBLY

DWG. NO.  
RFXXX-XXXX-XXXX-XXXX

BY: TIM P. 09-10-2010 SHEET 6 OF 7

**\*-S7SP**  
(STRAIGHT PLUG)

(USE DRAWING No. SSMB-P-C-XX-ST-CA1 FOR ASSEMBLY INSTRUCTIONS)

\* = FOR EXISTING CUSTOMERS ONLY



PLATING  
4: 10µ" MIN. GOLD CENTER CONTACT  
3µ" MIN. GOLD OUTER CONTACT  
100µ" MIN. NICKEL REMAINING METAL PARTS  
(END CONNECTOR P/N: SSMB-P-C-GF-ST-CA1)

NOTE: ALL CRITICAL DIMENSIONS ON SSMB-P-C-XX-ST-CA1 THAT APPLY MUST BE VERIFIED.

**-V3SJ**  
(STRAIGHT JACK)

(USE DRAWING No. MMCXV-J-C-XX-ST-CA1 FOR ASSEMBLY INSTRUCTIONS)

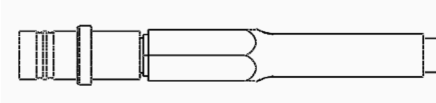

PLATING  
1: 30µ" MIN. GOLD CENTER CONTACT  
3µ" MIN. GOLD OUTER CONTACT  
3µ" MIN. NICKEL REMAINING METAL PARTS  
(END CONNECTOR P/N: MMCXV-J-C-HF-ST-CA1)

NOTE: ALL CRITICAL DIMENSIONS ON MMCXV-J-C-XX-ST-CA1 THAT APPLY MUST BE VERIFIED.

**-V3SP**  
(STRAIGHT PLUG)

(USE DRAWING No. MMCXV-P-C-XX-ST-CA1 FOR ASSEMBLY INSTRUCTIONS)



PLATING  
1: 30µ" MIN. GOLD CENTER CONTACT  
3µ" MIN. GOLD OUTER CONTACT  
3µ" MIN. NICKEL REMAINING METAL PARTS  
(END CONNECTOR P/N: MMCXV-P-C-HF-ST-CA1)

NOTE: ALL CRITICAL DIMENSIONS ON MMCXV-P-C-XX-ST-CA1 THAT APPLY MUST BE VERIFIED.

**-V3RP**  
(RIGHT ANGLE PLUG)

(USE DRAWING No. MMCXV-P-C-XX-RA-CA1 FOR ASSEMBLY INSTRUCTIONS)



PLATING  
1: 30µ" MIN. GOLD CENTER CONTACT  
3µ" MIN. GOLD OUTER CONTACT  
3µ" MIN. NICKEL REMAINING METAL PARTS  
(END CONNECTOR P/N: MMCXV-P-C-HF-RA-CA1)

NOTE: ALL CRITICAL DIMENSIONS ON MMCXV-P-C-XX-RA-CA1 THAT APPLY MUST BE VERIFIED.

**-23GJ**  
(STRAIGHT JACK)

(USE DRAWING No. AC-J-C-X-ST-CA1 FOR ASSEMBLY INSTRUCTIONS)

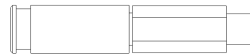

PLATING  
1: 30µ" MIN. GOLD CENTER CONTACT  
3µ" MIN. GOLD OUTER CONTACT  
3µ" MIN. NICKEL REMAINING METAL PARTS  
(END CONNECTOR P/N: AC-J-C-H-ST-CA1)

NOTE: ALL CRITICAL DIMENSIONS ON AC-J-C-X-ST-CA1 THAT APPLY MUST BE VERIFIED.

□ = FOR INTERNAL USE ONLY, NOT FOR SALE (SEE NOTE 19)

**-23GP**  
(STRAIGHT PLUG)

(USE DRAWING No. AC-P-C-X-ST-CA1 FOR ASSEMBLY INSTRUCTIONS)

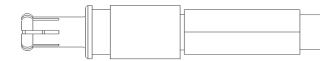

PLATING  
1: 30µ" MIN. GOLD CENTER CONTACT  
3µ" MIN. GOLD OUTER CONTACT  
3µ" MIN. NICKEL REMAINING METAL PARTS  
(END CONNECTOR P/N: AC-P-C-H-ST-CA1)

NOTE: ALL CRITICAL DIMENSIONS ON AC-P-C-X-ST-CA1 THAT APPLY MUST BE VERIFIED.

□ = FOR INTERNAL USE ONLY, NOT FOR SALE (SEE NOTE 19)

c:\enterprisevault\DWG\MISC\MKTG\RFXXXX-XXXX-XXXX-XXXX-MKT.SLDDRW

**PROPRIETARY NOTE**  
THIS DOCUMENT CONTAINS CONFIDENTIAL AND PROPRIETARY INFORMATION AND ALL DESIGN, MANUFACTURING, REPRODUCTION, USE, PATENT RIGHTS AND SALES RIGHTS ARE EXPRESSLY RESERVED BY SAMTEC, INC. THIS DOCUMENT SHALL NOT BE DISCLOSED, IN WHOLE OR PART, TO ANY UNAUTHORIZED PERSON OR ENTITY NOR REPRODUCED, TRANSFERRED OR INCORPORATED IN ANY OTHER PROJECT IN ANY MANNER WITHOUT THE EXPRESS WRITTEN CONSENT OF SAMTEC, INC.

DO NOT SCALE DRAWING

SHEET SCALE: 2:1



520 PARK EAST BLVD. NEW ALBANY, IN 47150  
PHONE: 812-944-6733 FAX: 812-948-5047  
e-Mail info@SAMTEC.com code 55322



DESCRIPTION:  
RF316 OR RF-174 CABLE ASSEMBLY

DWG. NO.  
RFXXXX-XXXX-XXXX-XXXX

BY: TIM P. 09-10-2010 SHEET 7 OF 7

## Looking for pricing, stock, or lifecycle information?

Click below to explore more details on WIN SOURCE:

-  [View RF316-13GP1-01SP1-1000 on WIN SOURCE](#)
-  [Samtec Inc. Information](#)

## Optimize Your Supply Chain with WIN SOURCE Solutions

-  Global Sourcing Solution
-  Obsolete Management
-  Cost Control Management
-  Shortage Management
-  Alternative Solution
-  Excess Inventory Management