



**THE DATASHEET OF  
L06031R2CGSTR**



# Thin-Film RF/Microwave Inductor Technology

## Accu-L® Series

### L0603 AND L0805 SMD High-Q RF Inductor – Accu-L®

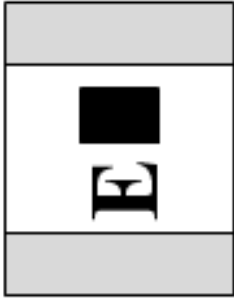

#### ACCU-L® TECHNOLOGY

The Accu-L® SMD Inductor is based on thin-film multilayer technology. This technology provides a level of control on the electrical and physical characteristics of the component which gives consistent characteristics within a lot and lot-to-lot.

The original design provides small size, excellent high-frequency performance and rugged construction for reliable automatic assembly.

The Accu-L® Inductor is particularly suited for the telecommunications industry where there is a continuing trend towards miniaturization and increasing frequencies. The Accu-L® inductor meets both the performance and tolerance requirements of present cellular frequencies 450MHz and 900MHz and of future frequencies, such as 1700MHz, 1900MHz and 2400MHz.

#### FEATURES

- Ultra-Tight Tolerance on Inductance
- RF Power Capability
- Low DC Resistance
- High SRF
- High Q

#### APPLICATIONS

- Vehicle Locations Systems
- Mobile Communications
- Satellite TV Receivers
- Matching Networks
- 5G Application
- Filters
- GPS

Not RoHS Compliant



For RoHS compliant products, please select correct termination style

#### HOW TO ORDER

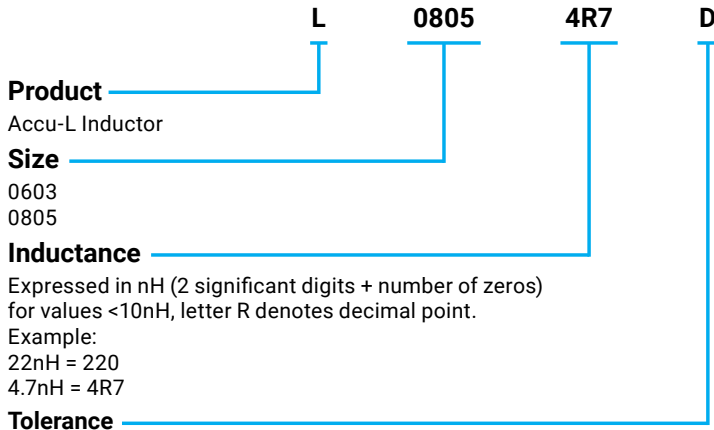

**Product**  
Accu-L Inductor

**Size**  
0603  
0805

**Inductance**  
Expressed in nH (2 significant digits + number of zeros)  
for values <10nH, letter R denotes decimal point.  
Example:  
22nH = 220  
4.7nH = 4R7

**Tolerance**

L ≤ 4.7nH	4.7nH < L < 10nH	L ≥ 10nH
B = ±0.1nH	C = ±0.2nH	G = ±2%
C = ±0.2nH	D = ±0.5nH	J = ±5%
D = ±0.5nH		

**Packaging Code**  
TR = Tape and Reel (3,000/reel)

**Termination Code**  
W = Nickel/Solder Coated (Sn 63, Pb 37)  
\*\*S = Nickel/Lead Free Solder Coated (Sn100)

**Specification Code**  
E = Accu-L® 0805 technology  
G = Accu-L® 0603 technology

\*\*RoHS Compliant

#### OPERATING / STORAGE TEMPERATURE

-55°C to +125°C

#### DIMENSIONS: millimeters (inches)

	0603	0805
L	1.6±0.10 (0.063±0.004)	2.11±0.10 (0.083±0.004)
W	0.81±0.10 (0.032±0.004)	1.5±0.10 (0.059±0.004)
T	0.61±0.10 (0.024±0.004)	0.91±0.13 (0.036±0.005)
B	top: 0.0 +0.3/-0.0 (0.0+0.012)	0.25±0.15 (0.010±0.006)
	bottom: 0.35±0.20 (0.014±0.008)	

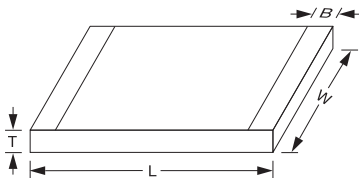

#### PART APPEARANCE (TOP VIEW)

##### ACCU-L 0603 (ALL VALUES)

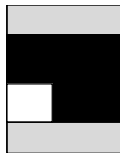

##### ACCU-L 0805

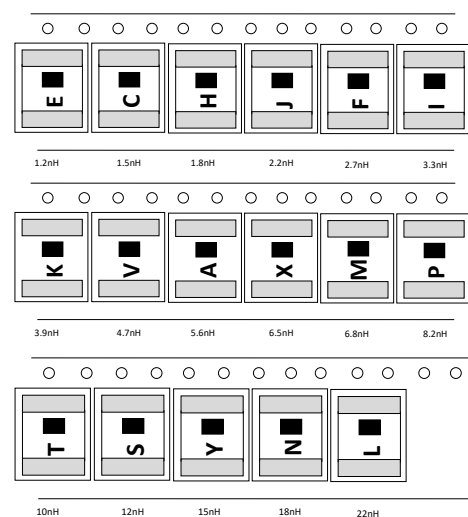

#### ELECTRICAL SPECIFICATIONS TABLE FOR ACCU-L® 0603

450 MHz Test Frequency			900 MHz Test Frequency		1900 MHz Test Frequency		2400 MHz Test Frequency		SRF min. (MHz)	R <sub>DC</sub> max. (Ω)	I <sub>DC</sub> max. (mA) (1)
Inductance L (nH)	Available Inductance Tolerance	Q Typical	L (nH)	Q Typical	L (nH)	Q Typical	L (nH)	Q Typical			
1.2	±0.1, ±0.2nH	49	1.2	70	1.2	134	1.2	170	10000	0.04	1000
1.5	±0.1, ±0.2nH	26	1.54	39	1.52	63	1.52	76	10000	0.06	1000
1.8	±0.1, ±0.2nH	20	1.74	30	1.73	50	1.72	59	10000	0.07	1000
2.2	±0.1, ±0.2nH	20	2.2	30	2.24	49	2.24	56	10000	0.08	1000
2.7	±0.1, ±0.2nH	21	2.7	30	2.75	48	2.79	54	9000	0.08	750
3.3	±0.1, ±0.2, ±0.5nH	24	3.33	35	3.39	56	3.47	64	8400	0.08	750
3.9	±0.1, ±0.2, ±0.5nH	25	3.9	57	4.06	60	4.21	69	6500	0.12	500
4.7	±0.1, ±0.2, ±0.5nH	23	4.68	32	4.92	46	5.2	49	5500	0.15	500
5.6	±0.2, ±0.5nH	26	5.65	36	5.94	54	6.23	60	5000	0.25	300
6.8	±0.2, ±0.5nH	23	6.9	33	7.3	47	8.1	39	4500	0.30	300
8.2	±0.2, ±0.5nH	23	8.4	31	10	35	12.1	31	3800	0.35	300
10.0	±2%, ±5%	28	10	39	11.8	47	14.1	41	3500	0.45	300
12.0	±2%, ±5%	28	13.2	38	14.1	30	17.2	20	3000	0.50	300
15.0	±2%, ±5%	28	16.2	38	25.9	30	49.8	15	2500	0.60	300

(1) IDC measured for 15°C rise at 25°C ambient temperature when soldered to FR-4 board.  
Inductance and Q measured on Agilent 4291B / 4287 using the 16196A test fixture.

#### ELECTRICAL SPECIFICATIONS TABLE FOR ACCU-L® 0805

450 MHz Test Frequency			900 MHz Test Frequency		1900 MHz Test Frequency		2400 MHz Test Frequency		SRF min. (MHz)	R <sub>DC</sub> max. (Ω)	I <sub>DC</sub> max. (mA)	
Inductance L (nH)	Available Inductance Tolerance	Q Typical	L (nH)	Q Typical	L (nH)	Q Typical	L (nH)	Q Typical			T = 15°C (1)	T = 70°C (2)
1.2	±0.1nH, ±0.2nH, ±0.5nH	60	1.2	92	1.2	122	1.2	92	10000	0.05	1000	2000
1.5	±0.1nH, ±0.2nH, ±0.5nH	50	1.5	74	1.5	102	1.5	84	10000	0.05	1000	2000
1.8	±0.1nH, ±0.2nH, ±0.5nH	50	1.8	72	1.8	88	1.9	73	10000	0.06	1000	2000
2.2	±0.1nH, ±0.2nH, ±0.5nH	42	2.2	62	2.2	82	2.3	72	10000	0.07	1000	2000
2.7	±0.1nH, ±0.2nH, ±0.5nH	42	2.7	62	2.8	80	2.9	70	10000	0.08	1000	2000
3.3	±0.1nH, ±0.2nH, ±0.5nH	38	3.3	46	3.4	48	3.5	57	10000	0.11	750	1500
3.9	±0.1nH, ±0.2nH, ±0.5nH	27	3.9	36	4.0	38	4.1	42	10000	0.20	750	1500
4.7	±0.1nH, ±0.2nH, ±0.5nH	43	4.8	62	5.3	76	5.8	60	5500	0.10	750	1500
5.6	±0.5nH	50	5.7	68	6.3	73	7.6	62	4600	0.10	750	1500
6.8	±0.5nH	43	7.0	62	7.7	71	9.4	50	4500	0.11	750	1500
8.2	±0.5nH	43	8.5	56	10.0	55	15.2	32	3500	0.12	750	1500
10	±2%, ±5%	46	10.6	60	13.4	52	-	-	2500	0.13	750	1500
12	±2%, ±5%	40	12.9	50	17.3	40	-	-	2400	0.20	750	1500
15	±2%, ±5%	36	16.7	46	27	23	-	-	2200	0.20	750	1000
18	±2%, ±5%	30	21.9	27	-	-	-	-	1700	0.35	500	1000
22	±2%, ±5%	36	27.5	33	-	-	-	-	1400	0.40	500	1000

(1) I<sub>DC</sub> measured for 15°C rise at 25°C ambient temperature  
(2) I<sub>DC</sub> measured for 70°C rise at 25°C ambient temperature

L, Q, SRF measured on HP 4291A, Boonton 34A and Wiltron 360 Vector Analyzer, RDC measured on Keithley 580 micro-ohmmeter.

L0603

### Typical Q vs. Frequency

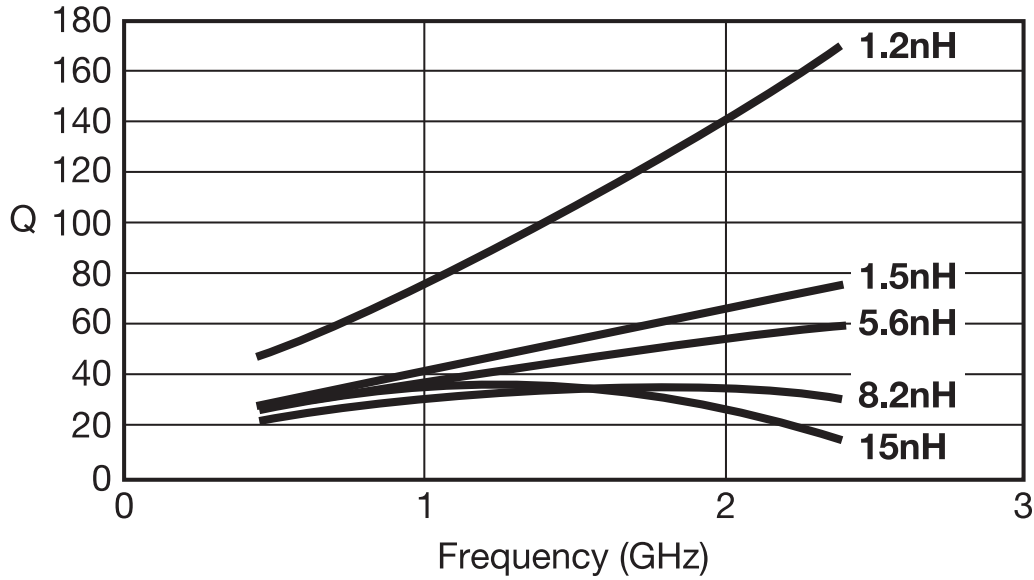

Measured on AGILENT 4291B/4287  
using the 16196A test fixture

### Typical Inductance vs. Frequency

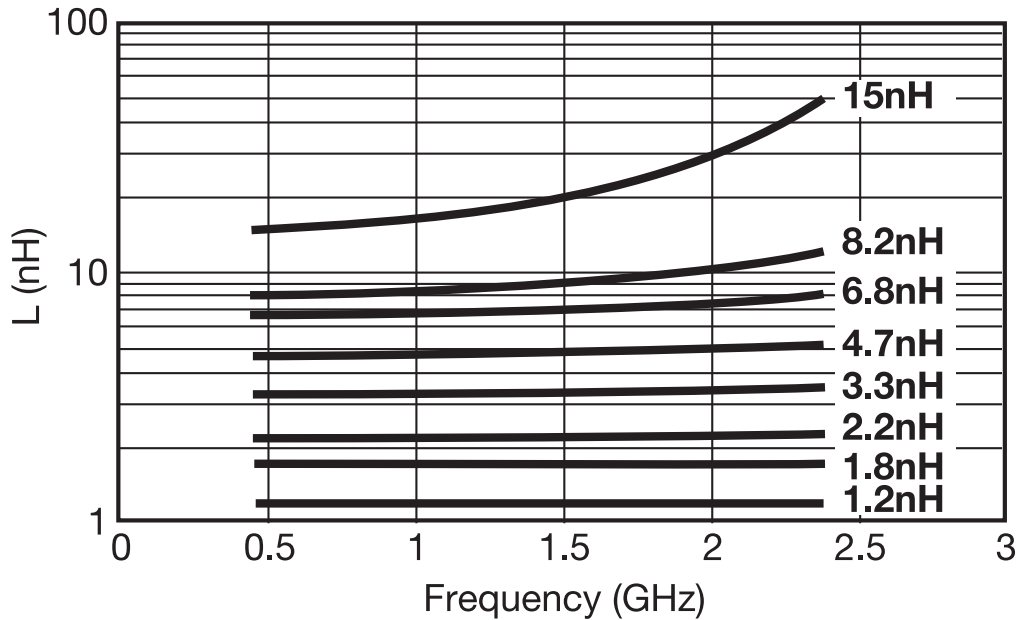

Measured on AGILENT 4291B/4287  
using the 16196A test fixture

#### L0805

Typical Q vs. Frequency  
L0805

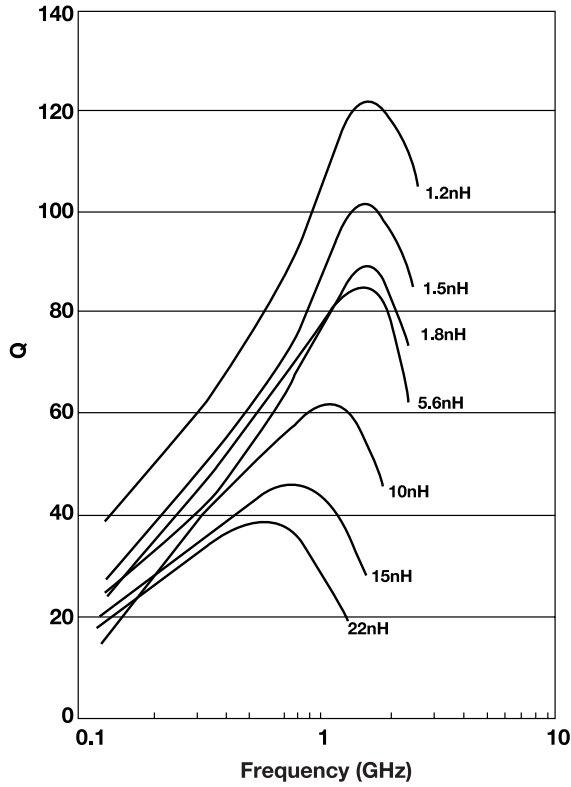

Measured on HP4291A and  
Boonton 34A Coaxial Line

Typical Inductance vs. Frequency  
L0805

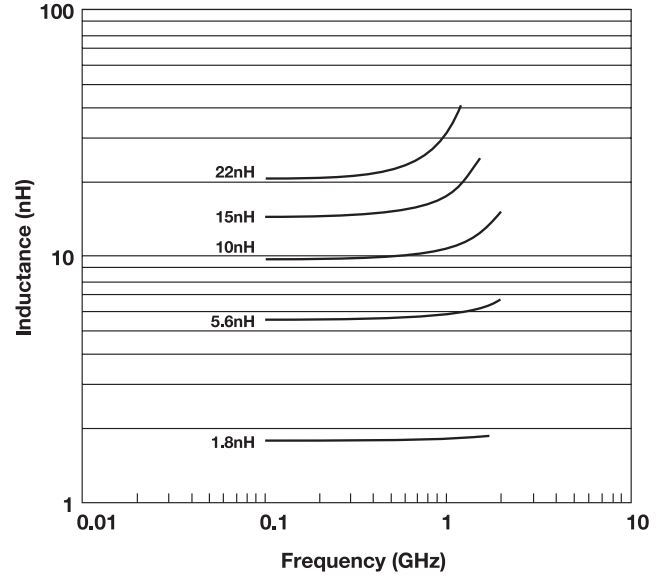

Measured on HP4291A and  
Wiltron 360 Vector Analyzer

Maximum Temperature Rise at 25°C  
Ambient Temperature (on FR-4)  
L0805

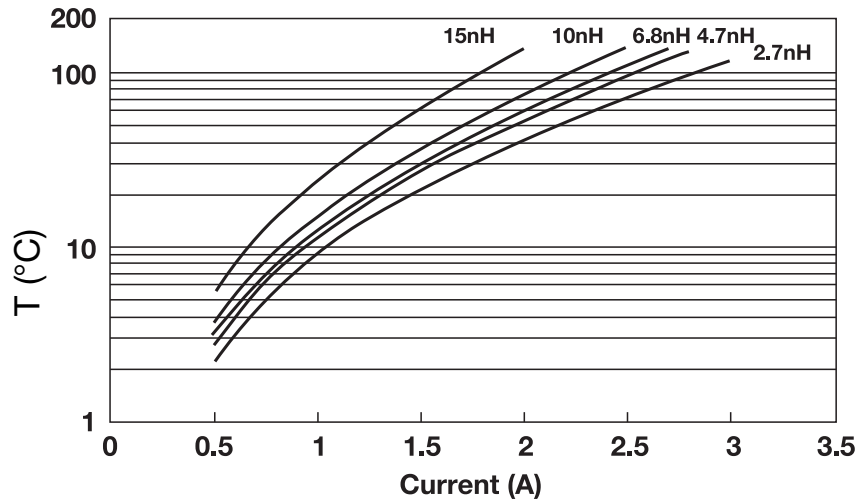

Temperature rise will typically be no higher than shown by the graph

#### FINAL QUALITY INSPECTION

Finished parts are tested for electrical parameters and visual/ mechanical characteristics.

Parts are 100% tested for inductance at 450MHz. Parts are 100% tested for RDC. Each production lot is evaluated on a sample basis for:

- Q at test frequency
- Static Humidity Resistance: 85°C, 85% RH, 160 hours
- Endurance: 125°C, I<sub>R</sub>, 4 hours

#### ENVIRONMENTAL CHARACTERISTICS

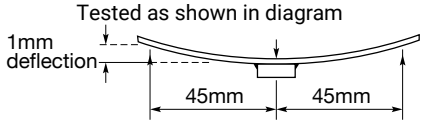
TEST	CONDITIONS	REQUIREMENT
Solderability	Components completely immersed in a solder bath at 235 ± 5°C for 2 secs.	Terminations to be well tinned. No visible damage.
Leach Resistance	Components completely immersed in a solder bath at 260 ± 5°C for 60 secs.	Dissolution of termination faces ≤ 15% of area. Dissolution of termination edges ≤ 25% of length.
Storage	12 months minimum with components stored in "as received" packaging.	Good solderability
Shear	Components mounted to a substrate. A force of 5N applied normal to the line joining the terminations and in a line parallel to the substrate.	No visible damage
Rapid Change of Temperature	Components mounted to a substrate. 5 cycles -55°C to +125°C.	No visible damage
Bend Strength	<p>Tested as shown in diagram</p> 	No visible damage
Temperature Coefficient of Inductance (TCL)	Component placed in environmental chamber -55°C to +125°C.	+0 to +125 ppm/°C (typical) T1 = 25°C $TCL = \frac{L_2 - L_1}{L_1 (T_2 - T_1)} \cdot 10^6$

#### HANDLING

SMD chips should be handled with care to avoid damage or contamination from perspiration and skin oils. The use of plastic tipped tweezers or vacuum pick-ups is strongly recommended for individual components. Bulk handling should ensure that abrasion and mechanical shock are minimized. For automatic equipment, taped and reeled product is the ideal medium for direct presentation to the placement machine.

#### CIRCUIT BOARD TYPE

All flexible types of circuit boards may be used (e.g. FR-4, G-10) and also alumina.

For other circuit board materials, please consult factory.

#### COMPONENT PAD DESIGN

Component pads must be designed to achieve good joints and minimize component movement during soldering.

Pad designs are given below for both wave and reflow soldering.

The basis of these designs is:

- Pad width equal to component width. It is permissible to decrease this to as low as 85% of component width but it is not advisable to go below this.
- Pad overlap about 0.3mm.
- Pad extension about 0.3mm for reflow.  
Pad extension about 0.8mm for wave soldering.

#### REFLOW SOLDERING

#### DIMENSIONS: millimeters (inches)

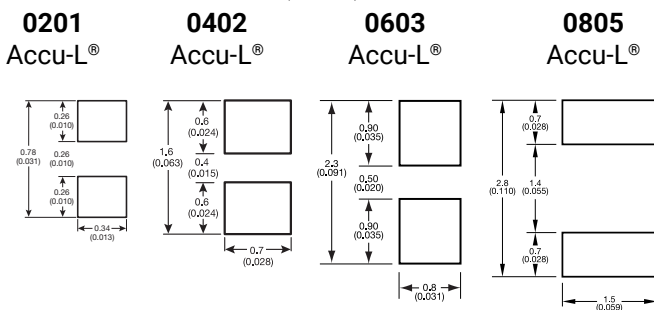

#### PREHEAT & SOLDERING

The rate of preheat in production should not exceed 4°C/second. It is recommended not to exceed 2°C/second.

Temperature differential from preheat to soldering should not exceed 150°C.

For further specific application or process advice, please consult KYOCERA AVX.

#### HAND SOLDERING & REWORK

Hand soldering is permissible. Preheat of the PCB to 100°C is required. The most preferable technique is to use hot air soldering tools. Where a soldering iron is used, a temperature controlled model not exceeding 30 watts should be used and set to not more than 260°C. Maximum allowed time at temperature is 1 minute. When hand soldering, the base side (white side) must be soldered to the board.

#### COOLING

After soldering, the assembly should preferably be allowed to cool naturally. In the event of assisted cooling, similar conditions to those recommended for preheating should be used.

#### CLEANING RECOMMENDATIONS

Care should be taken to ensure that the devices are thoroughly cleaned of flux residues, especially the space beneath the device. Such residues may otherwise become conductive and effectively offer a lossy bypass to the device. Various recommended cleaning conditions (which must be optimized for the flux system being used) are as follows:

- Cleaning liquids ..... i-propanol, ethanol, acetone, water, and other standard PCB cleaning liquids.
- Ultrasonic conditions ..... power – 20w/liter max.  
frequency – 20kHz to 45kHz.
- Temperature ..... 80°C maximum (if not otherwise limited by chosen solvent system).
- Time ..... 5 minutes max.

#### STORAGE CONDITIONS

Recommended storage conditions for Accu-L® prior to use are as follows:

- Temperature ..... 15°C to 35°C
- Humidity ..... ≤65%
- Air Pressure ..... 860mbar to 1060mbar

#### RECOMMENDED SOLDERING PROFILE

For recommended soldering profile see page 29

## Looking for pricing, stock, or lifecycle information?

Click below to explore more details on WIN SOURCE:

 [View L06031R2CGSTR](#) on WIN SOURCE

 [AVX Corp/Kyocera Corp](#) Information

## Optimize Your Supply Chain with WIN SOURCE Solutions

-  Global Sourcing Solution
-  Obsolete Management
-  Cost Control Management
-  Shortage Management
-  Alternative Solution
-  Excess Inventory Management