



**THE DATASHEET OF
BXRE-27E0800-B-03**



Bridgelux V8 Array Series

Product Data Sheet DS41

BXRE-xxx0800-A, BXRE-xxx0800-B

Introduction

The Bridgelux V8 LED Array products delivers high quality light in a compact and cost-effective solid-state lighting solution. These products can be efficiently driven at twice the normal current, enabling design flexibility not previously possible. This high flux density light source is designed to enable a wide range of sub 1000 lumen directional luminaires and replacement lamps for commercial and residential applications.

The V8 LED Array light engine is available in multiple electrical, CCT and CRI combinations providing considerable design-in flexibility and energy efficiencies.

Lighting system designs incorporating these LED Arrays deliver comparable performance to that of 40-75 Watt incandescent and halogen and 7-13 Watt compact fluorescent based luminaires they provide increased system level efficacy and longer service life. Typical applications include replacement lamps, task, accent, spot, track, down light, wide area, security, and wall pack.

Features

- Compact high flux density light source
- Uniform high quality illumination
- Minimum 70, 80 and 90 CRI options
- Streamlined thermal path
- Energy Star / ANSI compliant color binning structure with 3SDCM options
- More energy efficient than incandescent, halogen and fluorescent lamps
- Low voltage DC operation
- Instant light with unlimited dimming
- 5-Year warranty
- RoHS compliant and Pb free

Benefits

- Enhanced optical control
- Clean white light without pixilation
- High quality true color reproduction
- Significantly reduced thermal resistance and increased operating temperatures
- Uniform consistent white light
- Lower operating costs
- UL Recognized
- Easy to use with daylight and motion detectors to enable increased energy savings
- Reduced maintenance costs
- Environmentally friendly, no disposal issue
- CEC compliant versions available

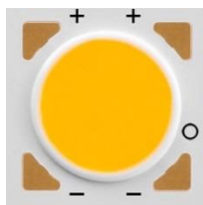
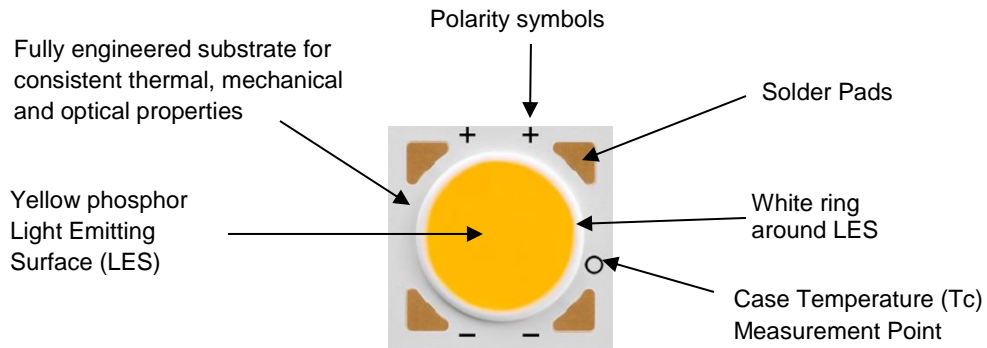

Table of Contents	Page
Typical Product Features	3
Product Nomenclature	3
Lumen Maintenance Characteristics	4
Environmental Compliance	4
UL Recognition	4
CE Recognition	4
Minor Product Change Policy	4
Case Temperature Measurement Point	4
Cautionary Statements	5
Selection Guide	6
Typical Performance at Alternative Drive Currents	7
Flux Characteristics	9
Electrical Characteristics	10
Absolute Maximum Ratings	11
Current versus Forward Voltage Characteristics	12
Typical Luminous Flux vs. Current	14
Typical Chromaticity Characteristics vs. Temperature	15
Typical Radiation Pattern	17
Mechanical Dimensions	19
Color Binning Information	20
Design Resources	23
About Bridgelux	24

Typical Product Features

Bridgelux arrays are fully engineered devices that provide consistent thermal and optical performance on an engineered mechanical platform. The V8 array is the smallest chip-on-board device across all of Bridgelux's LED Array products. The arrays incorporate several features to simplify design integration and assembly.

Figure 1: Array Features



Note: Part number and lot codes are scribed on back of array

Product Nomenclature

The part number designation for Bridgelux LED Arrays is explained as follows:

BXRE – AB C DEFG – H – IJ

Where:

B X R E – Designates product family

A B – Designates the nominal ANSI color temperature; 27 = 2700K; 30 = 3000K, etc.

C - Designates minimum CRI; C = 70, E = 80, G = 90

D E F G - Designates Nominal Flux; 0500 = 500lm, 0800 = 800lm, etc.

H – Designates configuration

I J – Designates CCT color binning

03 = 3SDCM or 3-step

04 = 4SDCM or 4-step

Lumen Maintenance Characteristics

Bridgelux projects that its family of LED Array products will deliver, on average, greater than 70% lumen maintenance after 50,000 hours of operation at the rated forward test current. This performance assumes constant current operation at the nominal drive current with case temperature maintained at or below 85°C. For use beyond these typical operating conditions please consult your Bridgelux sales representative for further assistance.

These projections are based on a combination of package test data, semiconductor chip reliability data, a fundamental understanding of package related degradation mechanisms, and performance observed from products installed in the field using Bridgelux die technology. Bridgelux conducts lumen maintenance tests per LM80. Observation of design limits is required in order to achieve this projected lumen maintenance.

Environmental Compliance

Bridgelux is committed to providing environmentally friendly products to the solid state lighting market. Bridgelux LED Arrays comply with the European Union directives on the restriction of hazardous substances in electronic equipment, namely the RoHS directive. Bridgelux does not intentionally add the following restricted materials to LED Array products: lead, mercury, cadmium, hexavalent chromium, polybrominated biphenyls (PBB) or polybrominated diphenyl ethers (PBDE).

UL Recognition

Bridgelux secures UL recognition for all the LED Array products. Please refer to the UL file E350613 for the latest list of UL recognized Arrays. Bridgelux uses UL recognized materials with suitable flammability ratings in the LED Array to streamline the process for customers to secure UL listing of the final luminaire product.

CE Recognition

In accordance with the relevant European Union directives, the family of LED Array products conform to the applicable requirements of the IEC/EN 62031:2008 (LED Modules for General Lighting Safety Specifications) and IEC 62471:2006 (Photobiological Safety of Lamps and Lamp Systems). Bridgelux maintains a CE Declaration of Conformity statement on its website and displays the CE mark on product packing labels.

Minor Product Change Policy

The rigorous qualification testing on products offered by Bridgelux provides performance assurance. Slight cosmetic changes that do not affect form, fit, or function may occur as Bridgelux continues product optimization.

Case Temperature Measurement Point

A case temperature (T_c) measurement point location is included on the top surface of the Bridgelux LED Arrays. The location of this measurement point is indicated in the mechanical dimensions section of this data sheet.

The purpose of this measurement point is to allow the user access to a measurement point closely linked to the true case temperature on the back surface of the LED Array. Once the LED Array is installed, it is challenging to measure the back surface of the array, or true case temperature.

Bridgelux has provided the case temperature measurement location in a manner which closely ties it to the true case temperature of the LED Array under steady state operation. Deviations between thermal measurements taken at the point indicated and the back of the LED Array differ by less than 1°C, providing a robust method to testing thermal operation once the product is installed.

Cautionary Statements

CAUTION: CONTACT WITH OPTICAL AREA

Avoid any contact with the optical area. Do not touch the optical area of the LED Array or apply mechanical stress to the yellow phosphor resin area – it could damage the LED Array.

Optics and reflectors must not be mounted in contact with the yellow phosphor resin area (LES) or the white ring that surrounds the yellow phosphor area. Using the white ring to secure optics can result in damage to the LED Array as the ring is not designed to act as a mechanical locating feature. Optical devices may be mounted on the top surface of the LED Array substrate outside of the white ring maximum OD as specified in the product data sheet. Use the mechanical features of the LED Array substrate edges and/or mounting holes to locate and secure the optical device as needed.

CAUTION: EYE SAFETY

Eye safety classification for the use of Bridgelux LED Arrays is in accordance with IEC specification EN62471; Photobiological Safety of Lamps and Lamp Systems. Bridgelux LED Arrays are classified as Risk Group 1 (Low Risk) when operated at or below their rated test current. Please use appropriate precautions. It is important that employees working with LEDs are trained to use them safely.

CAUTION: RISK OF BURN

Do not touch the LED Array or resin area during operation. Allow the LED Array to cool for a sufficient period of time before handling. The LED Array may reach elevated temperatures such that it can burn skin when touched.

CAUTION: CHEMICAL EXPOSURE HAZARD

Exposure to some chemicals commonly used in luminaire manufacturing and assembly can cause damage to the LED Array. Please consult Application Note AN11 for additional information.

Selection Guide

The following configurations are available:

Table 1: Selection Guide for V8 Arrays

Part Number ^[1]	CCT ^[2] (Kelvin)	CRI ^[3]	Test Current (mA)	Typical Voltage ^[4] (V)	Typical Flux ^[5,6] (lm)		Typical Power ^[4] (W)	Typical Efficacy ^[4] (lm/W)
					T _j = 25°C	T _{case} = 85°C		
BXRE-27E0800-A-03	2700K	80	175	35.6	705	615	6.2	113
BXRE-27E0800-B-03	2700K	80	350	17.8	705	615	6.2	113
BXRE-27G0800-A-03	2700K	90	175	35.6	565	490	6.2	91
BXRE-27G0800-B-03	2700K	90	350	17.8	565	490	6.2	91
BXRE-30E0800-A-03	3000K	80	175	35.6	730	635	6.2	117
BXRE-30E0800-B-03	3000K	80	350	17.8	730	635	6.2	117
BXRE-30G0800-A-03	3000K	90	175	35.6	595	515	6.2	96
BXRE-30G0800-B-03	3000K	90	350	17.8	595	515	6.2	96
BXRE-40E0800-A-03	4000K	80	175	35.6	770	670	6.2	124
BXRE-40E0800-B-03	4000K	80	350	17.8	770	670	6.2	124
BXRE-50C0800-A-04	5000K	70	175	35.6	850	740	6.2	136
BXRE-50C0800-B-04	5000K	70	350	17.8	850	740	6.2	136

Note for Table 1 through 5 (additional specific notes following Table 2 through 5):

1. The “-xx” suffix refers to color control, “-03” for 3 SDCM or “-04” for 4 SDCM.
2. Nominal CCT as defined by ANSI C78.377-2011.
3. CRI Values are minimum. Minimum R9 value for 90 CRI products is 50.
4. Products tested under pulsed condition (10ms pulse width) at rated test current where T_{junction} = T_{case} = 25°C.
5. Typical performance values are provided as a reference only and are not a guarantee of performance.
6. Bridgelux maintains a ±7% tolerance on flux measurements.

Typical Performance at Alternative Drive Currents

Customers may drive the LED Arrays at alternative drive currents dependent on the specific application. The typical performance at any drive current can be derived from the current vs. voltage characteristics shown in Figures 2 and 3 and from the flux versus current characteristics shown in Figure 8 and 9. The typical performance at common drive currents is summarized in Table 2.

Table 2: Typical Product Performance at Alternative Drive Currents

Part Number ^[1]	CCT & CRI ^[2,3]	Test Current ^[7] (mA)	Typical Voltage ^[4] (V)	Typical Power ^[4] (W)	Typical Flux ^[5,6] (lm)		Typical Efficacy ^[4] (lm/W)
			T _j = 25°C	T _j = 25°C	T _j = 25°C	T _{case} = 85°C	T _j = 25°C
BXRE-27E0800-A-03	2700K and 80 CRI	175	35.6	6.2	705	615	113
		250	37.1	9.3	970	845	105
		350	38.8	13.6	1310	1140	96
BXRE-27E0800-B-03	2700K and 80 CRI	350	17.8	6.2	705	615	113
		500	18.5	9.3	970	845	105
		700	19.4	13.6	1310	1140	96
BXRE-27G0800-A-03	2700K and 90 CRI	175	35.6	6.2	565	490	91
		250	37.1	9.3	775	675	84
		350	38.8	13.6	1050	910	77
BXRE-27G0800-B-03	2700K and 90 CRI	350	17.8	6.2	565	490	91
		500	18.5	9.3	775	675	84
		700	19.4	13.6	1050	910	77
BXRE-30E0800-A-03	3000K and 80 CRI	175	35.6	6.2	730	635	117
		250	37.1	9.3	1005	870	108
		350	38.8	13.6	1355	1180	100
BXRE-30E0800-B-03	3000K and 80 CRI	350	17.8	6.2	730	635	117
		500	18.5	9.3	1005	870	108
		700	19.4	13.6	1355	1180	100

Table 2 Continued: Typical Product Performance at Alternative Drive Currents

Part Number ^[1]	CCT & CRI ^[2,3]	Test Current ^[7] (mA)	Typical Voltage ^[4] (V)	Typical Power ^[4] (W)	Typical Flux ^[5,6] (lm)		Typical Efficacy ^[4] (lm/W)
			T _j = 25°C	T _j = 25°C	T _j = 25°C	T _{case} = 85°C	T _j = 25°C
BXRE-30G0800-A-03	3000K and 90 CRI	175	35.6	6.2	595	515	96
		250	37.1	9.3	815	705	88
		350	38.8	13.6	1105	955	81
BXRE-30G0800-B-03	3000K and 90 CRI	350	17.8	6.2	595	515	96
		500	18.5	9.3	815	705	88
		700	19.4	13.6	1105	955	81
BXRE-40E0800-A-03	4000K and 80 CRI	175	35.6	6.2	770	670	124
		250	37.1	9.3	1060	920	114
		350	38.8	13.6	1430	1245	105
BXRE-40E0800-B-03	4000K and 80 CRI	350	17.8	6.2	770	670	124
		500	18.5	9.3	1060	920	114
		700	19.4	13.6	1430	1245	105
BXRE-50C0800-A-04	5000K and 70 CRI	175	35.6	6.2	850	740	136
		250	37.1	9.3	1170	1015	126
		350	38.8	13.6	1580	1375	116
BXRE-50C0800-B-04	5000K and 70 CRI	350	17.8	6.2	850	740	136
		500	18.5	9.3	1170	1015	126
		700	19.4	13.6	1580	1375	116

Notes for Table 2 (notes 1 through 6 located under Table 1):

7. Values in **bold** correspond to rated test currents from Table 1. Alternate values are provide for reference only and are not guaranteed.

Flux Characteristics

Table 3: Flux Characteristics

Part Number ^[1]	CCT ^[2] (Kelvin)	CRI ^[3]	Test Current (mA)	Minimum Flux ^[8] (lm)	Minimum Flux ^[9] (lm)	Typical Flux ^[4] (lm)	Typical CBCP ^[4,10] (cd)
				T _j = 25°C	T _{case} = 85°C	T _{case} = 85°C	T _j = 25°C
BXRE-27E0800-A-03	2700K	E	175	635	555	615	225
BXRE-27E0800-B-03	2700K	E	350	635	555	615	225
BXRE-27G0800-A-03	2700K	G	175	510	440	490	180
BXRE-27G0800-B-03	2700K	G	350	510	440	490	180
BXRE-30E0800-A-03	3000K	E	175	655	570	635	230
BXRE-30E0800-B-03	3000K	E	350	655	570	635	230
BXRE-30G0800-A-03	3000K	G	175	540	465	515	190
BXRE-30G0800-B-03	3000K	G	350	540	465	515	190
BXRE-40E0800-A-03	4000K	E	175	695	605	670	245
BXRE-40E0800-B-03	4000K	E	350	695	605	670	245
BXRE-50C0800-A-04	5000K	C	175	765	665	740	270
BXRE-50C0800-B-04	5000K	C	350	765	665	740	270

Notes for Table 3 (notes 1 through 7 located under Table 1 and 2):

8. Bridgelux maintains a tester tolerance of $\pm 7\%$ on flux measurements. Minimum flux values at the rated test current are guaranteed by 100% test.
9. Minimum flux values at elevated temperatures are provided for reference only and are not guaranteed by 100% production testing. Based on Bridgelux test setup, values may vary depending on the thermal design of luminaire and/or the environment in which the product is operated.
10. Center beam candle power is a calculated value based on Lambertian radiation pattern at rated test current.

Electrical Characteristics

Table 4: Electrical Characteristics

Part Number ^[1]	Test Current (mA)	Operating Voltage $T_j = 25^\circ\text{C}$ ^[5, 11] (V)			Typical Coefficient of Forward Voltage ^[12] (mV/°C) $\Delta V_f/\Delta T_j$	Typical Thermal Resistance Junction to Case (°C/W) $R_{\theta j-c}$
		Minimum	Typical	Maximum		
BXRE-27E0800-A-03	175	32.4	35.6	39.2	-12 to -36	2.70
BXRE-27E0800-B-03	350	16.2	17.8	19.6	-6 to -18	2.70
BXRE-27G0800-A-03	175	32.4	35.6	39.2	-12 to -36	2.70
BXRE-27G0800-B-03	350	16.2	17.8	19.6	-6 to -18	2.70
BXRE-30E0800-A-03	175	32.4	35.6	39.2	-12 to -36	2.70
BXRE-30E0800-B-03	350	16.2	17.8	19.6	-6 to -18	2.70
BXRE-30G0800-A-03	175	32.4	35.6	39.2	-12 to -36	2.70
BXRE-30G0800-B-03	350	16.2	17.8	19.6	-6 to -18	2.70
BXRE-40E0800-A-03	175	32.4	35.6	39.2	-12 to -36	2.70
BXRE-40E0800-B-03	350	16.2	17.8	19.6	-6 to -18	2.70
BXRE-50C0800-A-04	175	32.4	35.6	39.2	-12 to -36	2.70
BXRE-50C0800-B-04	350	16.2	17.8	19.6	-6 to -18	2.70

Notes for Table 4 (notes 1 through 10 located under Table 1 through 3):

11. Bridgelux maintains a tester tolerance of ± 0.10 V on forward voltage measurements. Voltage minimum and maximum values at the rated test current are guaranteed by 100% test.
12. Typical Coefficient of Forward Voltage tolerance of ± 0.1 from nominal current.

Absolute Maximum Ratings

Table 5: Maximum Current and Reverse Voltage Ratings ^[18]

Part Number ^[1]	DC Forward Current for LM-80 (mA) ^[16,17,18]	Maximum Peak Pulsed Current (mA) ^[13, 15]	Maximum Reverse Voltage (Vr) ^[14]
BXRE-xxx0500-A-xx	350	500	-40
BXRE-xxx0800-A-xx	350	500	-60
BXRE-xxx0800-B-xx	700	1000	-30

Notes for Table 5 (notes 1 through 12 located under Table 1 through 4):

13. Bridgelux recommends a maximum duty cycle of 10% when operating LED Arrays at the maximum peak pulsed current specified.
14. Light emitting diodes are not designed to be driven in reverse voltage.
15. Maximum peak pulsed currents are values at which the LED Array can be driven without catastrophic failures.
16. DC Forward Current for LM-80 are the maximum drive currents for which LM-80 data is currently available.
17. Lumen maintenance (L70) and lifetime predictions are valid for drive current and case temperature conditions used for LM-80 testing as included in the applicable LM-80 test report for these arrays.
18. Arrays may be driven at higher currents but lumen maintenance may be reduced.

Table 6: Maximum Ratings

Parameter	Maximum Rating
LED Junction Temperature	150°C
Storage Temperature	-40°C to +105°C
Operating Case Temperature	105°C ^[2]
Soldering Temperature ^[1]	350°C or lower for a maximum of 3.5 seconds

Note for Table 6:

1. Refer to Bridgelux Application Note AN41: Assembly Considerations for Bridgelux LED Arrays.
2. For IEC 62717 requirement, please consult your Bridgelux sales representative.

Current versus Forward Voltage Characteristics

Figure 2: Typical Current vs. Voltage – BXRE-xxx0800-A-xx

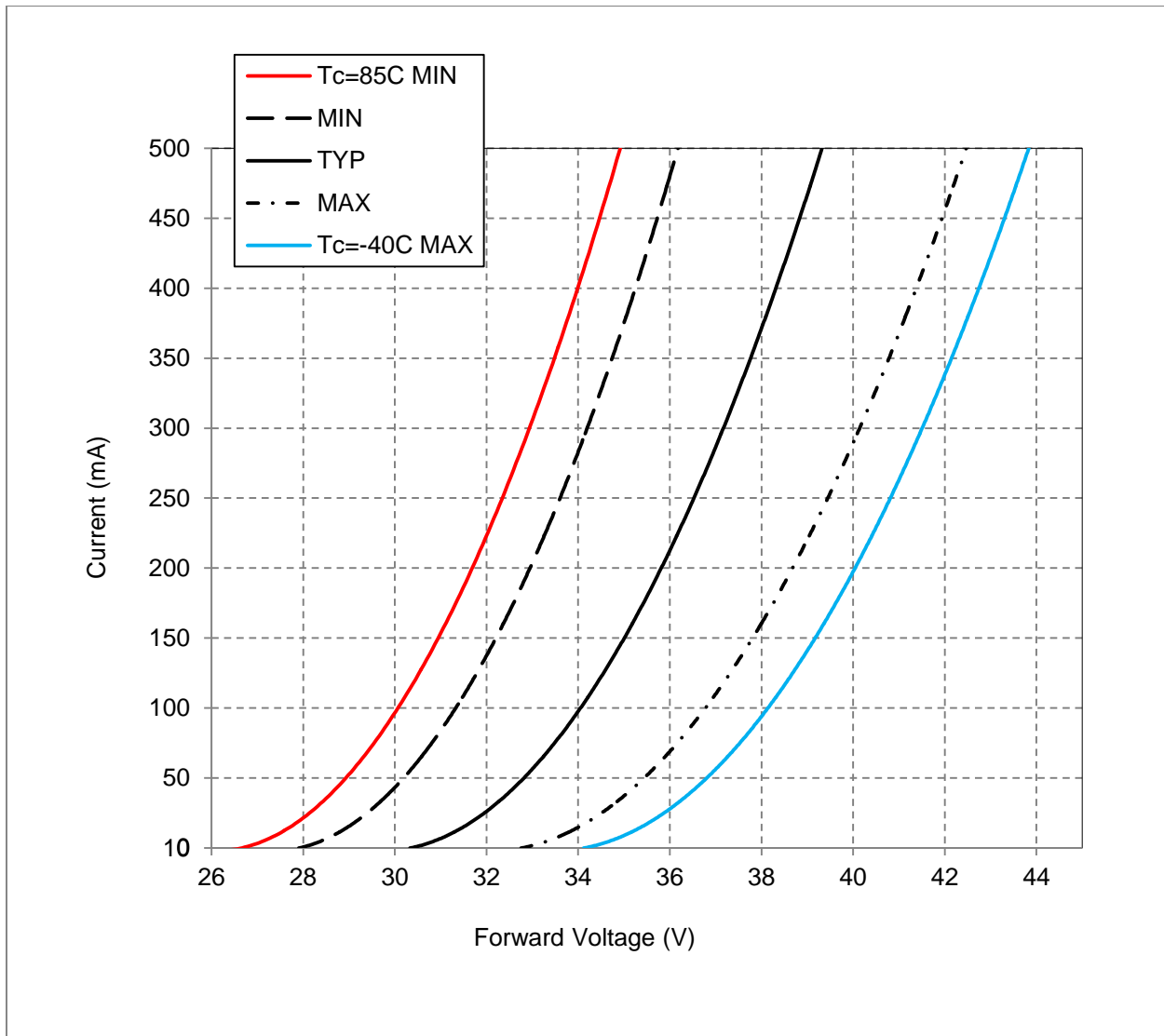

Current versus Forward Voltage Characteristics Continued

Figure 3: Typical Current vs. Voltage – BXRE-xxx0800-B-xx

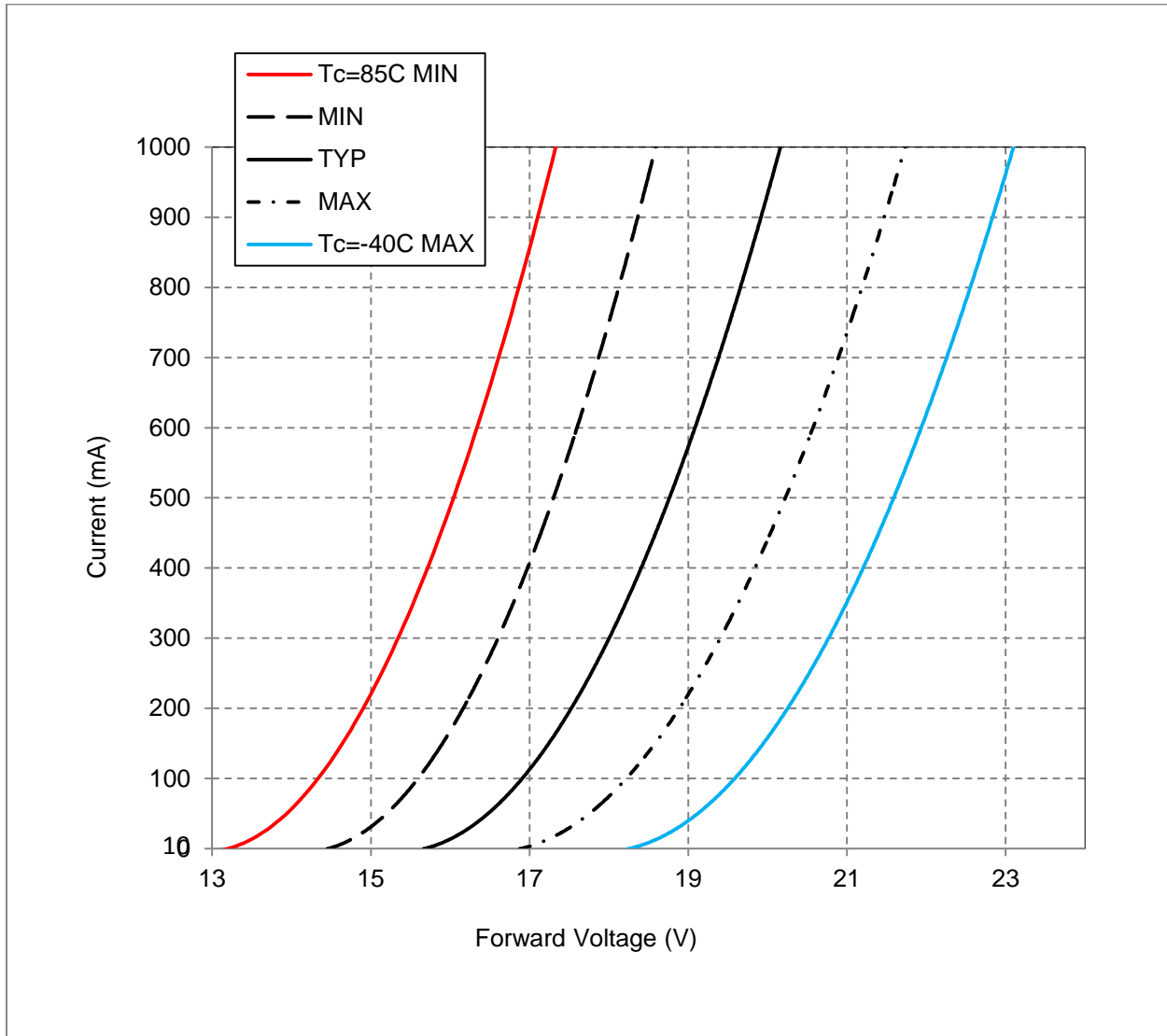

Typical Luminous Flux vs. Current

Typical performance at any drive current can be derived from the current versus voltage characteristics shown in Figures 2, 3 and 4 and the flux versus current characteristics shown in Figures 5 and 6. Normalized typical flux corresponds to LED tested under pulsed conditions where junction temperature = case temperature = 25°C.

Figure 4: Typical Flux vs. Current – BXRE-xxx-0800-A-xx

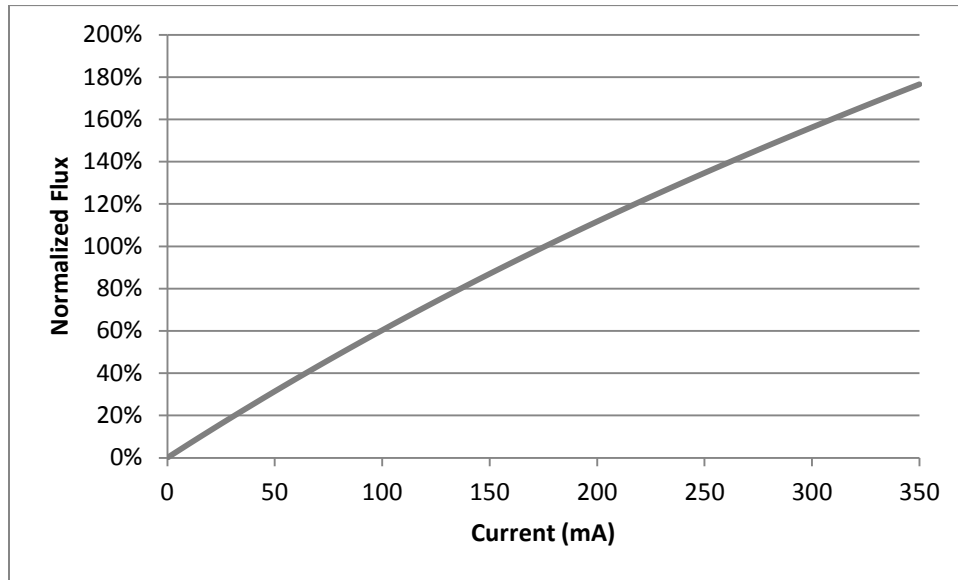
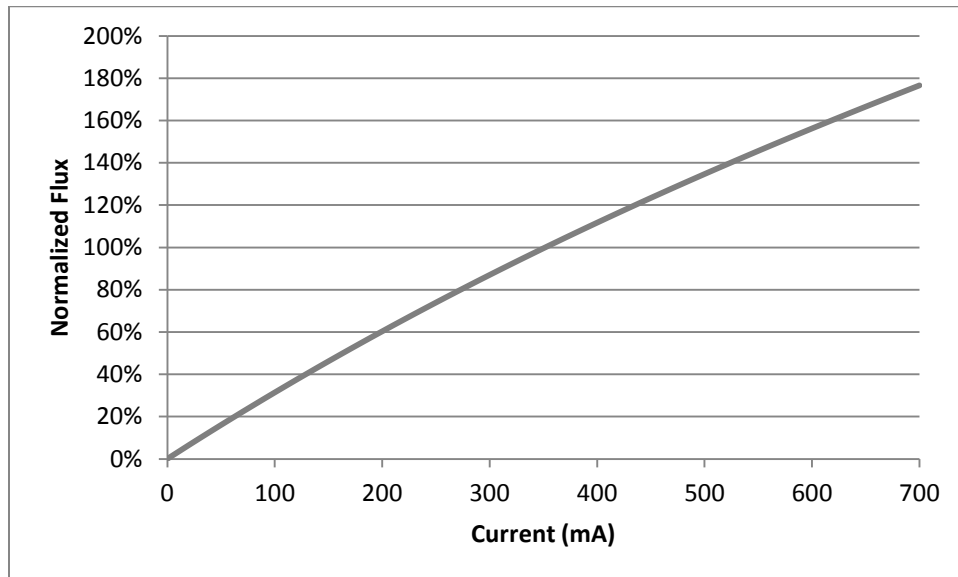

Figure 5: Typical Flux vs. Current – BXRE-xxx-0800-B-xx



Note: Bridgelux does not recommend driving high power LED Arrays at low currents. Doing so may produce unpredictable results. Pulse width modulation (PWM) is recommended for dimming effects.

Typical Chromaticity Characteristics vs. Temperature

Figure 6: Typical Flux vs. Junction Temperature

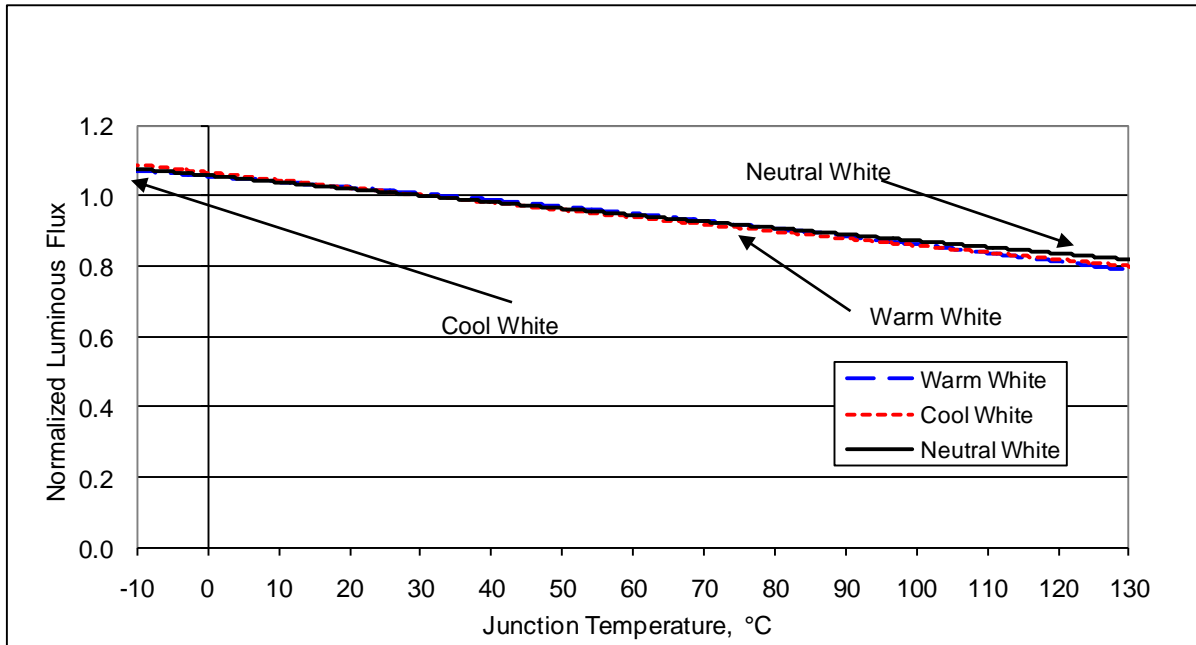

Note for figures 6, 7 and 8:

1. Characteristics shown for Warm White 3000K 80CRI
2. Characteristics shown for Neutral White 4000K 80CRI
3. Characteristics shown for Neutral White 4000K 80CRI

Typical Chromaticity Characteristics versus Temperature (continued)

Figure 7: Typical ccy Shift vs. Junction Temperature

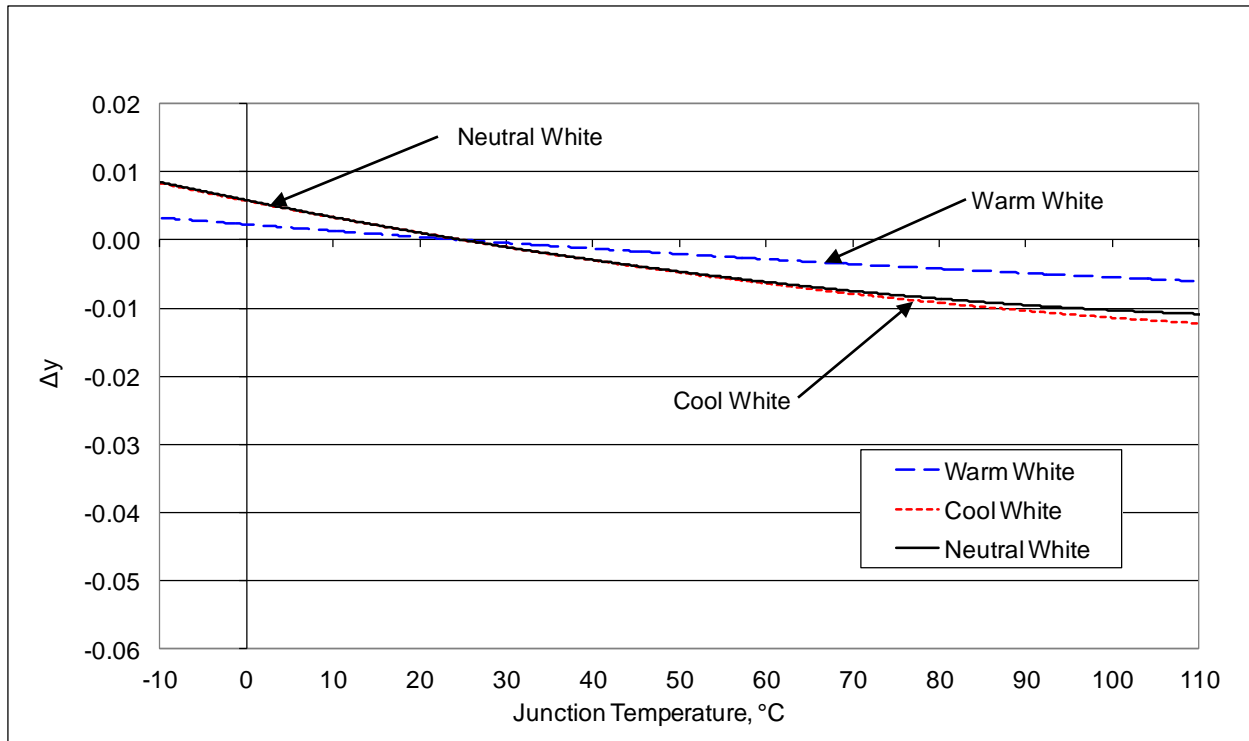
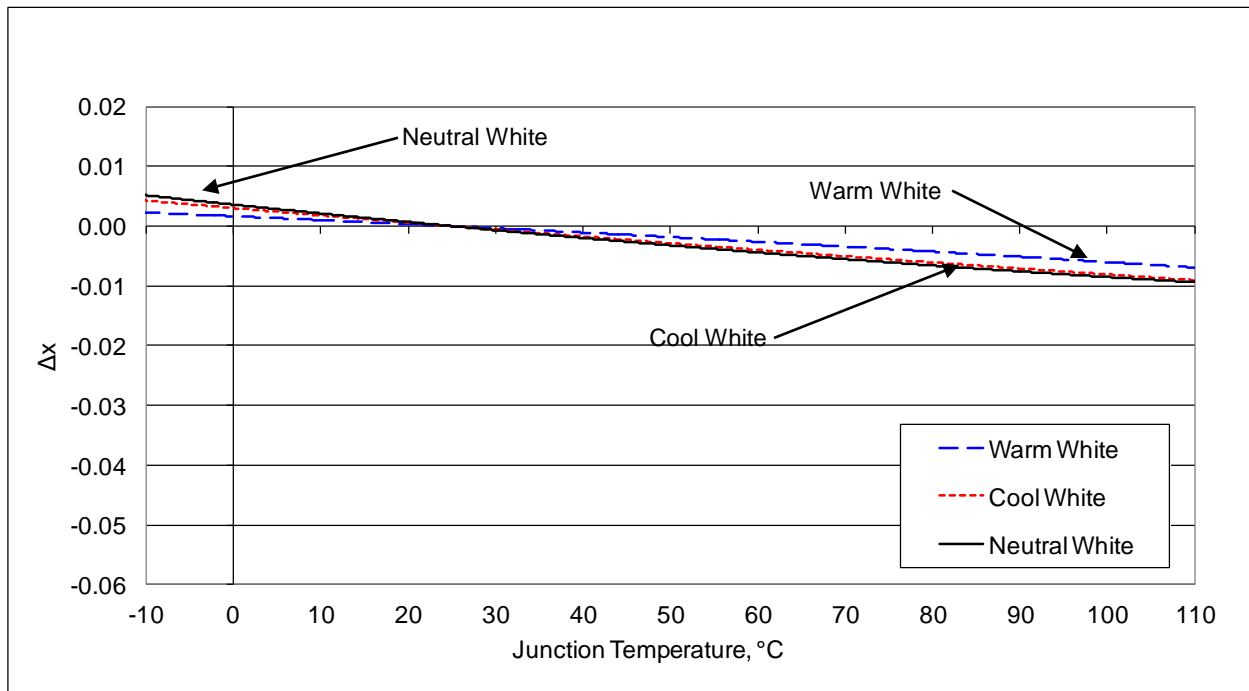
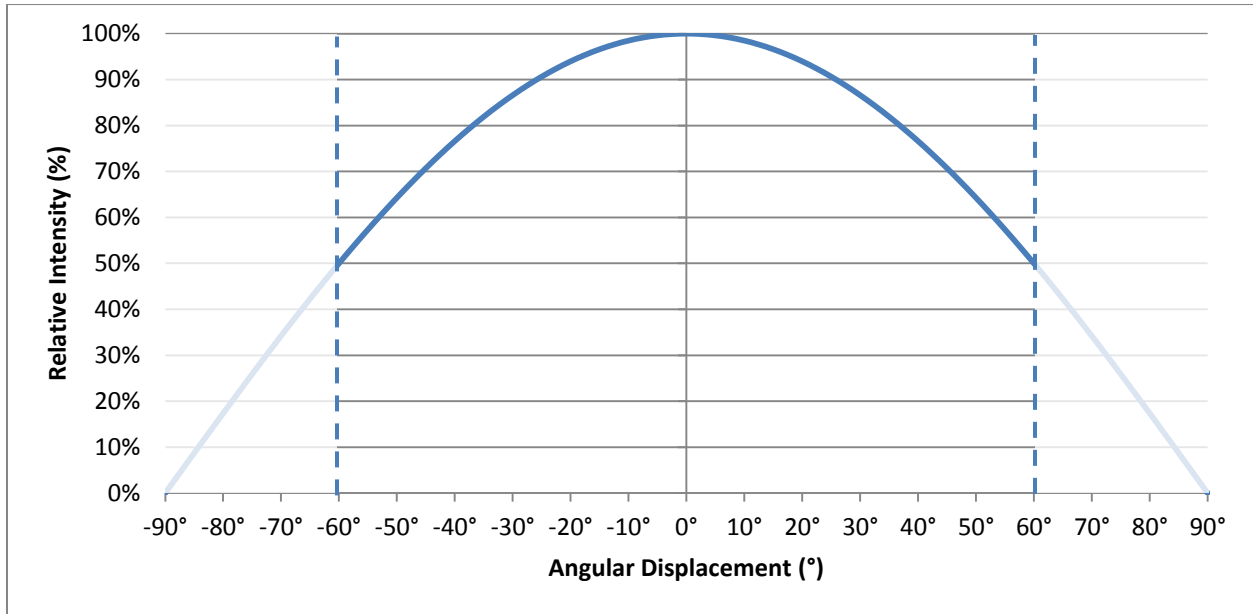

Figure 8: Typical ccx Shift vs. Junction Temperature



Typical Radiation Pattern

Figure 9: Typical Spatial Radiation Pattern



Notes for figure 9:

1. Typical viewing angle is 120°.
2. The viewing angle is defined as the off axis angle from the centerline where I_v is $\frac{1}{2}$ of the peak value.

Figure 10: Typical Polar Radiation Pattern

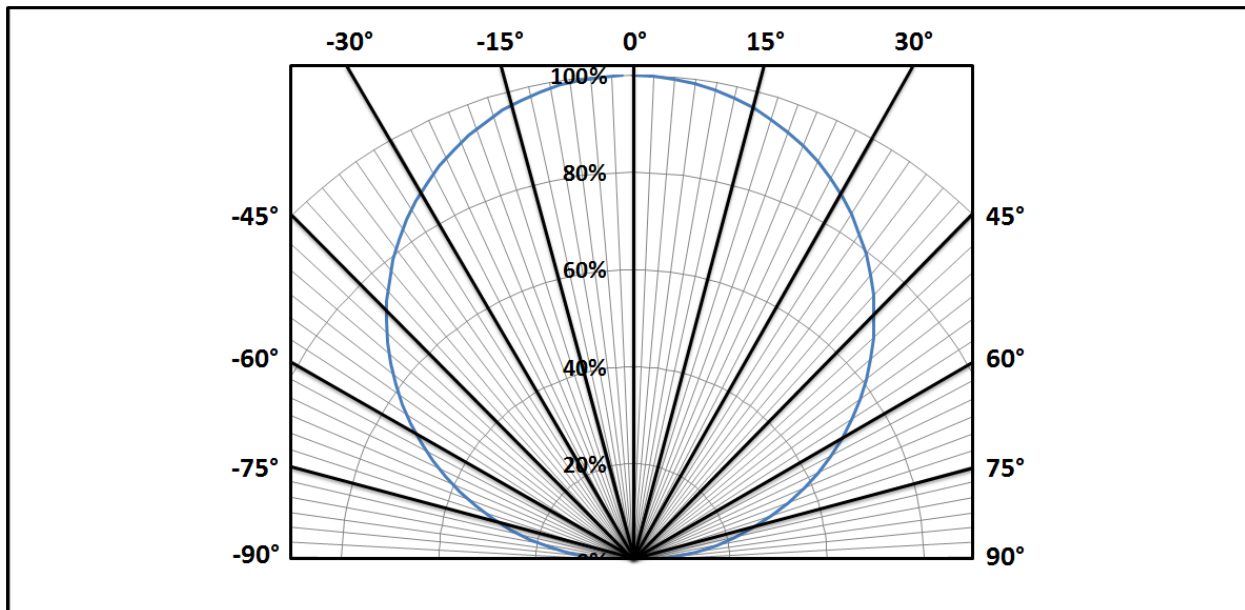

Typical Radiation Pattern

Figure 11: Typical Color Spectrum

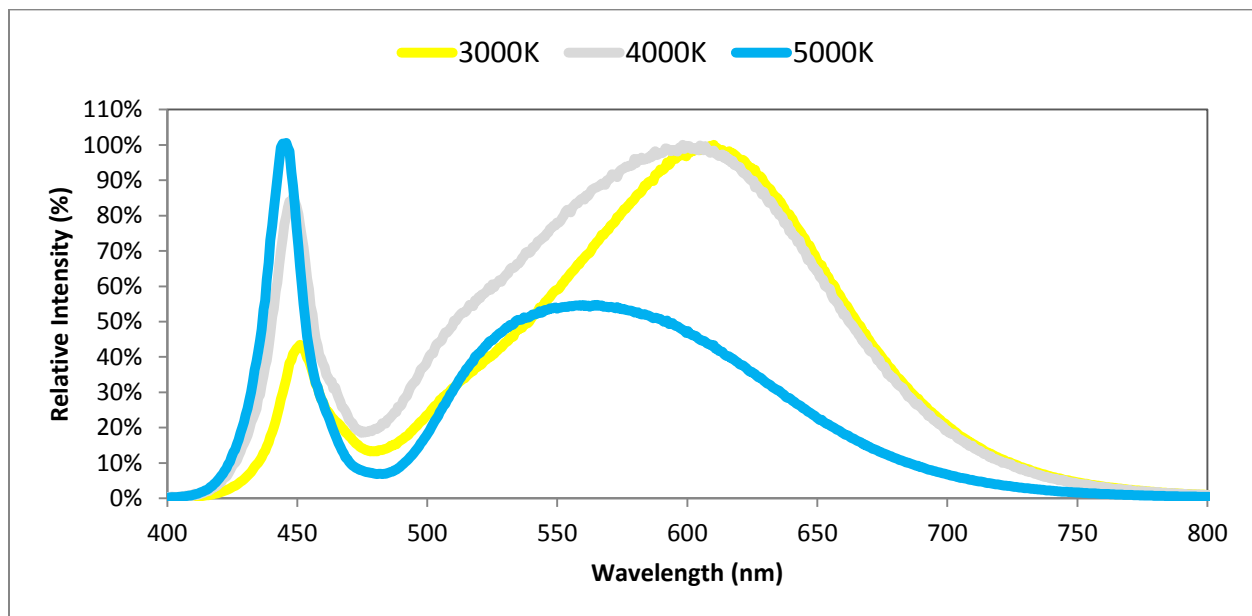

Notes for Figure 11:

1. Color spectra measured at rated current and $T_j = 25^\circ\text{C}$.
2. Color spectrum shown for warm white is 3000K and 80 CRI.
3. Color spectrum shown for neutral white is 4000K and 80 CRI.
4. Color spectrum shown for cool white is 5000K and 70 CRI.

Mechanical Dimensions

Figure 12: Drawing for V8 Arrays

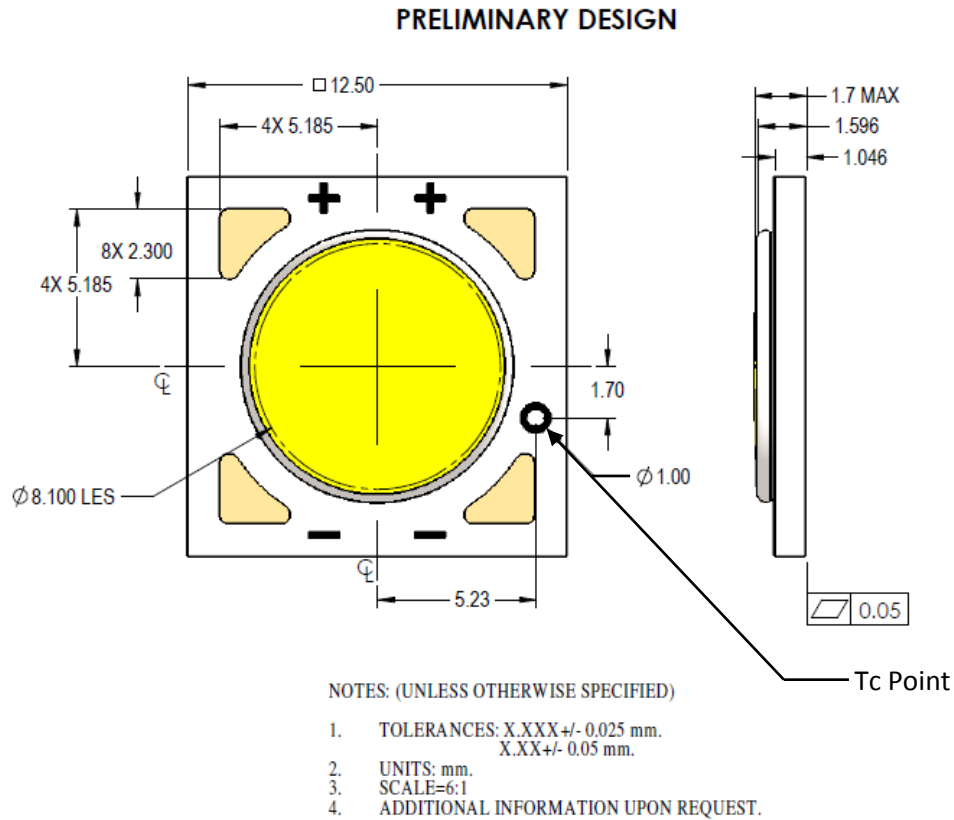

Notes for Figure 12:

1. Mounting holes are for M2.5 or #4 screws.
2. Solder pads are labeled "+" and "-" to denote positive and negative, respectively.
3. It is not necessary to provide electrical connections to both sets of solder pads. Either set may be used depending on application specific design requirements.
4. Drawings are not to scale.
5. Drawing dimensions are in millimeters.
6. Unless otherwise specified, tolerances are ± 0.10 mm.
7. The optical center of the LED Array is nominally defined by the mechanical center of the array. The light emitting surface (LES) is centered on the mechanical center of the array to a tolerance of ± 0.45 mm
8. Bridgelux maintains a flatness of 0.1 mm across the mounting surface of the array. Refer to Application Notes AN40 and AN41 for product handling, mounting and heat sink recommendations.

Color Binning Information

Figure 13: Graph of Warm White Test Bins in xy Color Space

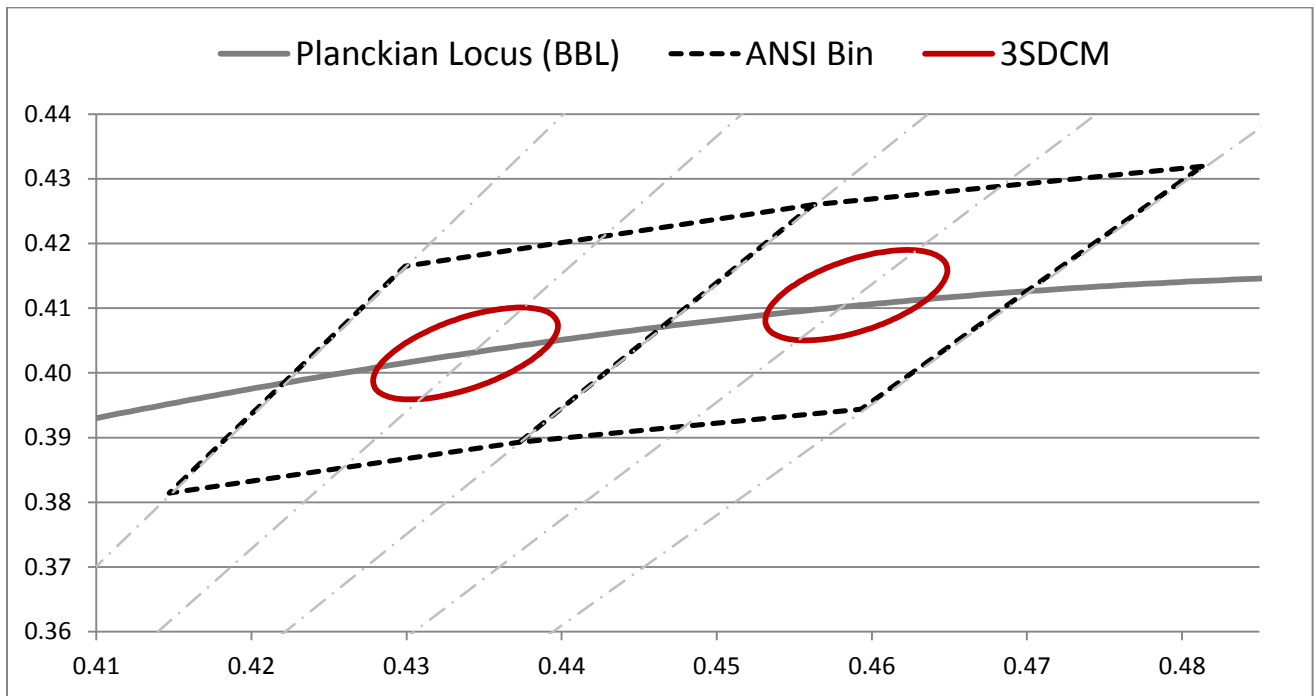

Note: 3SDCM bins are shown inside standard ANSI bins for comparison purposes.

Table 7: Warm White xy Bin Coordinates and Associated Typical CCT

Bin Code	2700K	3000K
ANSI Bin (for reference only)	(2580K - 2870K)	(2870K - 3220K)
03 (3SDCM)	(2651K - 2794K)	(2968K - 3136K)
Center Point (x,y)	(0.4578, 0.4101)	(0.4338, 0.403)

Color Binning Information (continued)

Figure 14: Graph of Neutral White Test Bins in xy Color Space

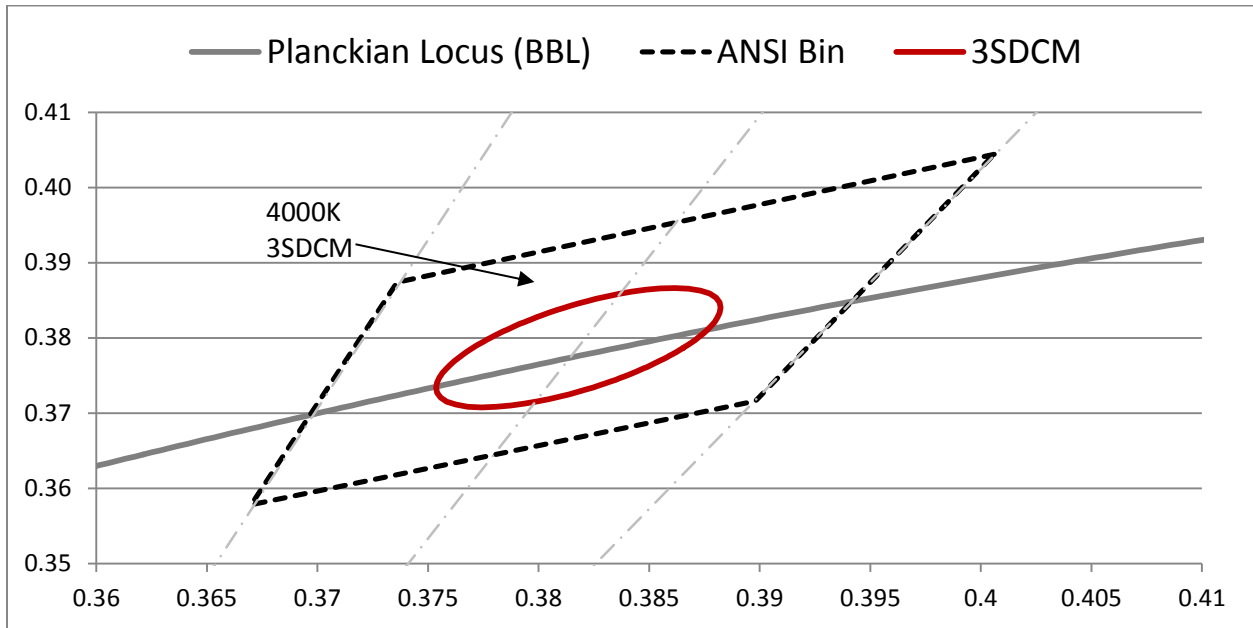

Note: 3SDCM bin is shown inside standard ANSI bins for comparison purposes.

Table 8: Neutral White xy Bin Coordinates and Associated Typical CCT

Bin Code	4000K
ANSI Bin (for reference only)	(3710K - 4260K)
03 (3SDCM)	(3851K - 4130K)
Center Point (x,y)	(0.3818, 0.3797)

Color Binning Information (continued)

Figure 15: Graph of Cool White Test Bins in xy Color Space

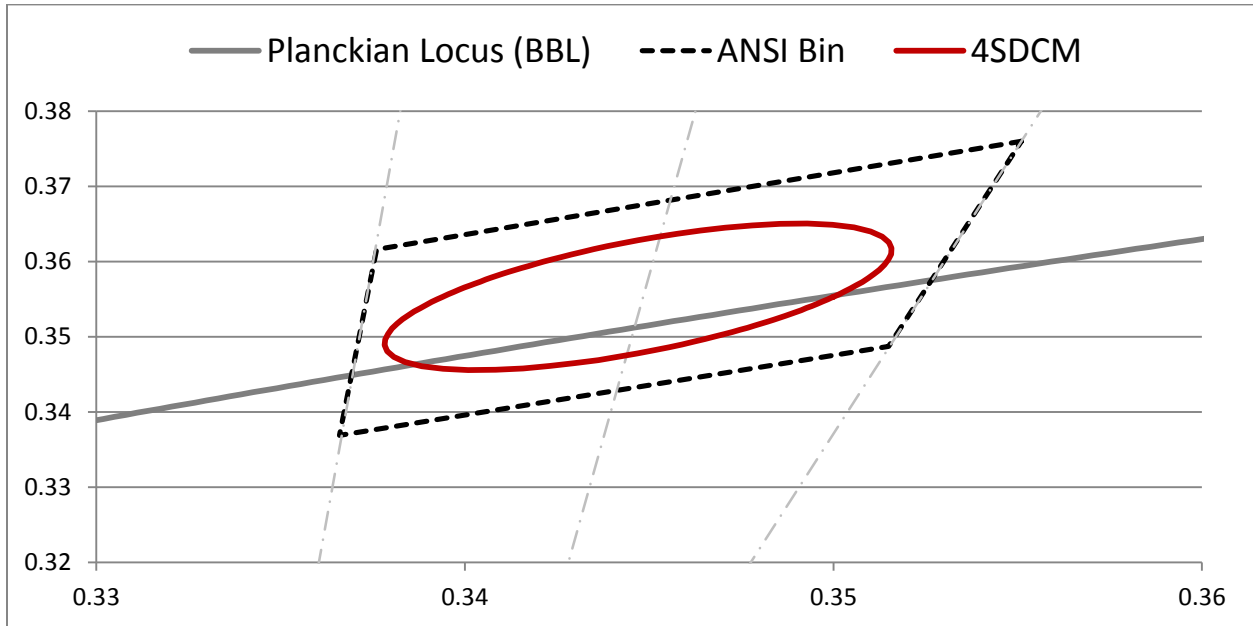

Note: 4SDCM bin is shown inside standard ANSI bins for comparison purposes.

Table 9: Cool White xy Bin Coordinates and Associated Typical CCT

Bin Code	5000K
ANSI Bin (for reference only)	(4745K - 5311K)
04 (4SDCM)	(4801K - 5282K)
Center Point (x,y)	(0.3447, 0.3553)

Design Resources

Bridgelux has developed a comprehensive set of application notes and design resources to assist customers in successfully designing with Bridgelux LED Array products. Included below is a list of available resources which can be downloaded from the Bridgelux web site under the Design Resources section.

These documents are updated regularly as new information becomes available, including complimentary infrastructure products such as commercially available secondary optics and electronic driver solutions.

Application Notes

- AN40: Effective Thermal Management of Bridgelux LED Arrays
- AN41: Assembly Considerations for Bridgelux LED Arrays
- AN42: Electrical Drive Considerations for Bridgelux LED Arrays
- AN44: Reliability Data Sheet for Bridgelux LED Arrays
- AN46: Optical Considerations for Bridgelux LED Arrays

Optical Source Models

Optical source models and ray set files are available for all Bridgelux LED Array products, and can be downloaded directly from the Bridgelux web site. The list below contains the formats currently available. If you require a specific format not included in this list, please contact your Bridgelux sales representative for assistance.

- Zemax
- ASAP
- IESNA
- LightTools
- LucidShape
- OPTIS SPEOS
- PHOTOPIA
- TracePro
- Radiant Imaging Source Model

3D CAD Models

Three dimensional CAD models depicting the product outline of all Bridgelux LED Arrays are available in both SAT and STEP formats. These CAD files can be downloaded directly from the Bridgelux web site.

About Bridgelux

Bridgelux is a leading developer and manufacturer of technologies and solutions transforming the \$40 billion global lighting industry into a \$100 billion market opportunity. Based in Livermore, California, Bridgelux is a pioneer in solid-state lighting (SSL), expanding the market for light-emitting diode (LED) technologies by driving down the cost of LED lighting systems. Bridgelux's patented light source technology replaces traditional technologies (such as incandescent, halogen, fluorescent and high intensity discharge lighting) with integrated, solid-state lighting solutions that enable lamp and luminaire manufacturers to provide high performance and energy-efficient white light for the rapidly growing interior and exterior lighting markets, including street lights, commercial lighting and consumer applications. With more than 550 patent applications filed or granted worldwide, Bridgelux is the only vertically integrated LED manufacturer and developer of solid-state light sources that designs its solutions specifically for the lighting industry.

For more information about the company, please visit www.bridgelux.com



© 2013 Bridgelux, Inc. All rights reserved. Product specifications are subject to change without notice.

Looking for pricing, stock, or lifecycle information?

Click below to explore more details on WIN SOURCE:

 [View BXRE-27E0800-B-03 on WIN SOURCE](#)

 [Bridgelux Information](#)

Optimize Your Supply Chain with WIN SOURCE Solutions

-  Global Sourcing Solution
-  Obsolete Management
-  Cost Control Management
-  Shortage Management
-  Alternative Solution
-  Excess Inventory Management