

24-Bit, 96 kHz Stereo DAC with Volume Control

Features

- 101 dB Dynamic Range
- -91 dB THD+N
- +3.0 V or +5.0 V Power Supply
- Low Clock-Jitter Sensitivity
- Filtered Line-Level Outputs
- On-Chip Digital De-Emphasis for 32, 44.1 and 48 kHz
- ATAPI Mixing
- Digital Volume Control with Soft Ramp
 - 94 dB Attenuation
 - 1 dB Step Size
 - Zero Crossing Click-Free Transitions
- Popguard® Technology for Control of Clicks and Pops
- 33 mW with 3.0 V Supply

Description

The CS4341 is a complete stereo digital-to-analog system including digital interpolation, fourth-order Delta-Sigma digital-to-analog conversion, digital de-emphasis and switched capacitor analog filtering. The advantages of this architecture include: ideal differential linearity, no distortion mechanisms due to resistor matching errors, no linearity drift over time and temperature and a high tolerance to clock jitter.

The CS4341 accepts data at audio sample rates from 4 kHz to 100 kHz, consumes very little power, and operates over a wide power supply range. The features of the CS4341 are ideal for DVD players, CD players, set-top box and automotive systems.

ORDERING INFORMATION

CS4341-KS	16-pin SOIC, -10 to 70 °C
CS4341-CZZ, Lead Free	16-pin TSSOP, -10 to 70 °C
CDB4341	Evaluation Board

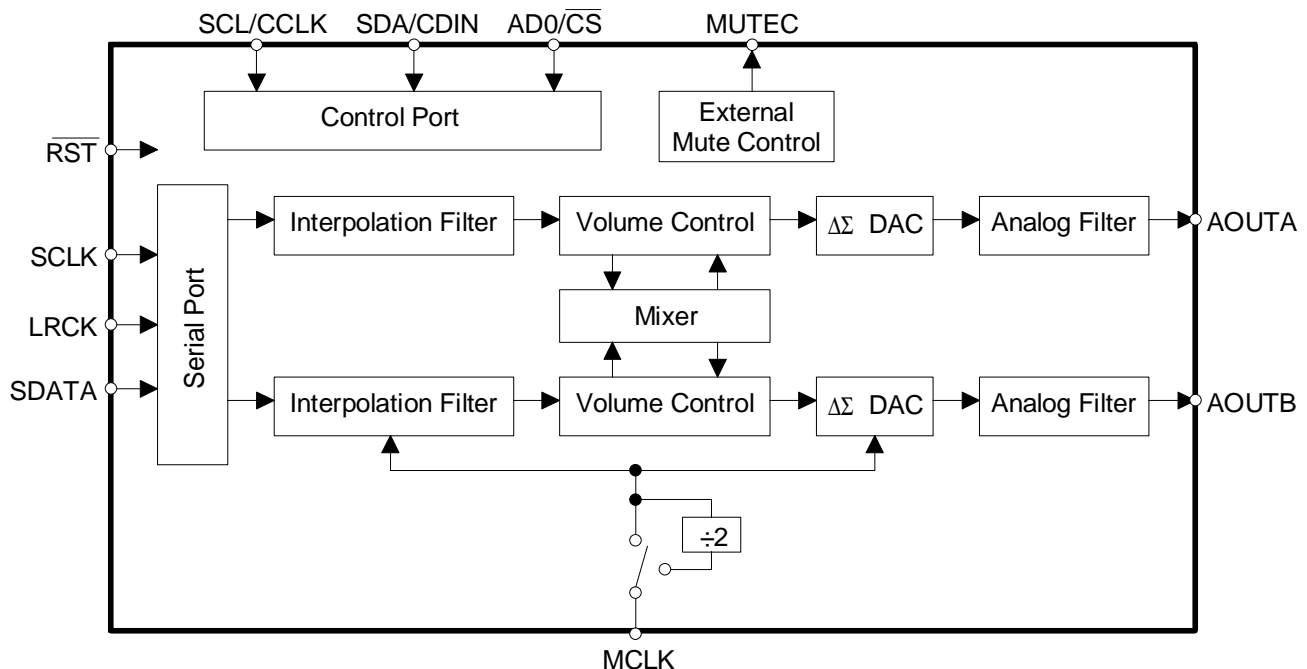

TABLE OF CONTENTS

1. CHARACTERISTICS AND SPECIFICATIONS	4
SPECIFIED OPERATING CONDITIONS	4
ABSOLUTE MAXIMUM RATINGS	4
ANALOG CHARACTERISTICS (CS4341-KS/CZZ).....	5
COMBINED INTERPOLATION & ON-CHIP ANALOG FILTER RESPONSE.....	7
SWITCHING SPECIFICATIONS - SERIAL AUDIO INTERFACE.....	10
SWITCHING CHARACTERISTICS - INTERNAL SERIAL CLOCK	11
SWITCHING CHARACTERISTICS - CONTROL PORT INTERFACE (I ² C®)	12
SWITCHING CHARACTERISTICS - CONTROL PORT INTERFACE (SPI™)	13
DC ELECTRICAL CHARACTERISTICS.....	14
DIGITAL INPUT CHARACTERISTICS	14
DIGITAL INTERFACE SPECIFICATIONS.....	14
2. PIN DESCRIPTION	15
3. TYPICAL CONNECTION DIAGRAM	16
4. APPLICATIONS	17
4.1 Sample Rate Range/Operational Mode	17
4.2 System Clocking	17
4.2.1 Internal Serial Clock Mode	17
4.2.2 External Serial Clock Mode	18
4.3 Digital Interface Format	18
4.4 De-Emphasis	19
4.5 Power-Up Sequence	19
4.6 Popguard® Transient Control	19
4.6.1 Power-Up	19
4.6.2 Power-Down	20
4.6.3 Discharge Time	20
4.7 Mute Control	20
4.8 Grounding and Power Supply Arrangements	20
4.9 Control Port Interface	20
4.9.1 Rise Time for Control Port Clock	21
4.9.2 Memory Address Pointer (MAP)	21
4.9.2a INCR (Auto Map Increment)	21
4.9.2b MAP0-3 (Memory Address Pointer)	21
4.9.3 I ² C Mode	21
4.9.3a I ² C Write	22
4.9.3b I ² C Read	22
4.9.4 SPI Mode	23
4.9.4a SPI Write	23
5. REGISTER QUICK REFERENCE	24
6. REGISTER DESCRIPTION	25
6.1 MCLK Control (address 00h)	25
6.2 Mode Control (address 01h)	25
6.3 Transition and Mixing Control (address 02h)	27
6.4 Channel A Volume Control (address 03h)	29
6.5 Channel B Volume Control (address 04h)	29
7. PARAMETER DEFINITIONS	31
8. PACKAGE DIMENSIONS	32

8.1 SOIC	32
8.2 TSSOP	33
9. PACKAGE THERMAL RESISTANCE	33
10. REFERENCES	34
11. REVISION HISTORY	34

LIST OF FIGURES

Figure 1. Output Test Load	6
Figure 2. Maximum Loading	6
Figure 3. Single-Speed Stopband Rejection	8
Figure 4. Single-Speed Transition Band	8
Figure 5. Single-Speed Transition Band (Detail)	8
Figure 6. Single-Speed Passband Ripple	8
Figure 7. Double-Speed Stopband Rejection	8
Figure 8. Double-Speed Transition Band	8
Figure 9. Double-Speed Transition Band (Detail)	9
Figure 10. Double-Speed Passband Ripple	9
Figure 11. Serial Input Timing (External SCLK)	10
Figure 12. Internal Serial Mode Input Timing	11
Figure 13. Internal Serial Clock Generation	11
Figure 14. Control Port Timing - I ² C Mode	12
Figure 15. Control Port Timing - SPI Mode	13
Figure 16. Typical Connection Diagram	16
Figure 17. CS4341 Formats 0-1 - I ² S up to 24-Bit Data	18
Figure 18. CS4341 Format 2 - Left Justified up to 24-Bit Data	18
Figure 19. CS4341 Formats 3-6 - Right Justified	18
Figure 20. De-Emphasis Curve	19
Figure 21. I ² C Buffer Example	21
Figure 22. I ² C Write	22
Figure 23. I ² C Read	23
Figure 24. Control Port Timing, SPI Mode	23
Figure 25. ATAPI Block Diagram	29

LIST OF TABLES

Table 1. CS4341 Speed Modes	17
Table 2. Single-Speed Mode Standard Frequencies	17
Table 3. Double-Speed Mode Standard Frequencies	17
Table 4. Internal SCLK/LRCK Ratio	18
Table 5. Digital Interface Format	26
Table 6. ATAPI Decode	28
Table 7. Example Digital Volume Settings	30

1. CHARACTERISTICS AND SPECIFICATIONS

(Min/Max performance characteristics and specifications are guaranteed over the Specified Operating Conditions. Typical performance characteristics are derived from measurements taken at $T_A = 25^\circ\text{C}$.)

SPECIFIED OPERATING CONDITIONS (All voltages with respect to AGND = 0 V.)

Parameters	Symbol	Min	Nom	Max	Units
DC Power Supply					
Nominal 3.3 V	VA	2.7	3.3	3.6	V
Nominal 5.0 V	VA	4.75	5.0	5.5	V
Specified Operating Temperature (Power Applied)	-KS/CZZ T_A	-10	-	+70	$^\circ\text{C}$

ABSOLUTE MAXIMUM RATINGS (AGND = 0 V; all voltages with respect to AGND. Operation beyond these limits may result in permanent damage to the device. Normal operation is not guaranteed at these extremes.)

Parameters	Symbol	Min	Max	Units
DC Power Supply	VA	-0.3	6.0	V
Input Current (Note 1)	I_{in}	-	± 10	mA
Digital Input Voltage	V_{IND}	-0.3	VA+0.4	V
Ambient Operating Temperature (power applied)	T_A	-55	125	$^\circ\text{C}$
Storage Temperature	T_{stg}	-65	150	$^\circ\text{C}$

Notes: 1. Any pin except supplies.

ANALOG CHARACTERISTICS (CS4341-KS/CZZ) (Test conditions (unless otherwise specified): Input test signal is a 997 Hz sine wave at 0 dBFS; measurement bandwidth is 10 Hz to 20 kHz; test load $R_L = 10\text{ k}\Omega$, $C_L = 10\text{ pF}$ (see Figure 1).)

Parameter		VA = 5.0 V			VA = 3.0 V			Unit	
		Min	Typ	Max	Min	Typ	Max		
Single-Speed Mode		Fs = 48 kHz							
Dynamic Range 18 to 24-Bit	(Note 2) unweighted	93	98	-	89	94	-	dB	
	A-Weighted	96	101	-	92	97	-	dB	
	16-Bit	unweighted	-	92	-	-	92	-	dB
		A-Weighted	-	95	-	-	95	-	dB
Total Harmonic Distortion + Noise 18 to 24-Bit	(Note 2) 0 dB	-	-91	-86	-	-94	-89	dB	
	-20 dB	-	-78	-	-	-74	-	dB	
	-60 dB	-	-38	-	-	-34	-	dB	
	16-Bit	0 dB	-	-90	-	-	-91	-	dB
		-20 dB	-	-72	-	-	-72	-	dB
		-60 dB	-	-32	-	-	-32	-	dB
Double-Speed Mode		Fs = 96 kHz							
Dynamic Range 18 to 24-Bit	(Note 2) unweighted	93	98	-	89	94	-	dB	
	A-Weighted	96	101	-	92	97	-	dB	
	16-Bit	unweighted	-	92	-	-	92	-	dB
		A-Weighted	-	95	-	-	95	-	dB
Total Harmonic Distortion + Noise 18 to 24-Bit	(Note 2) 0 dB	-	-91	-86	-	-94	-89	dB	
	-20 dB	-	-78	-	-	-74	-	dB	
	-60 dB	-	-38	-	-	-34	-	dB	
	16-Bit	0 dB	-	-90	-	-	-91	-	dB
		-20 dB	-	-72	-	-	-72	-	dB
		-60 dB	-	-32	-	-	-32	-	dB

ANALOG CHARACTERISTICS (CS4341-KS/CZZ) (Continued)

Parameters	Symbol	Min	Typ	Max	Units
Dynamic Performance for All Modes					
Interchannel Isolation (1 kHz)		-	100	-	dB
DC Accuracy					
Interchannel Gain Mismatch		-	0.1	-	dB
Gain Drift		-	±100	-	ppm/°C
Analog Output Characteristics and Specifications					
Full-Scale Output Voltage		0.6•VA	0.7•VA	0.8•VA	V _{pp}
Output Impedance		-	100	-	Ω
Minimum AC-Load Resistance (Note 3)	R _L	-	3	-	kΩ
Maximum Load Capacitance (Note 3)	C _L	-	100	-	pF

- Notes: 2. One-half LSB of triangular PDF dither is added to data.
 3. Refer to Figure 2.

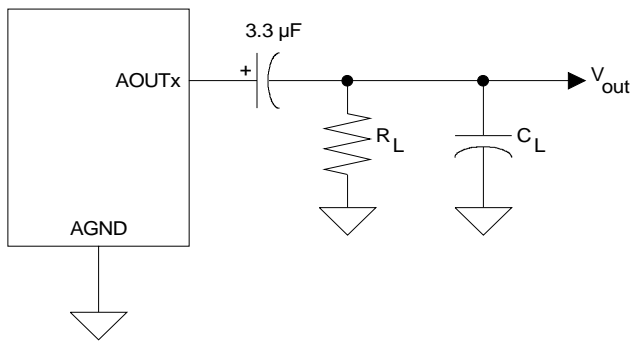
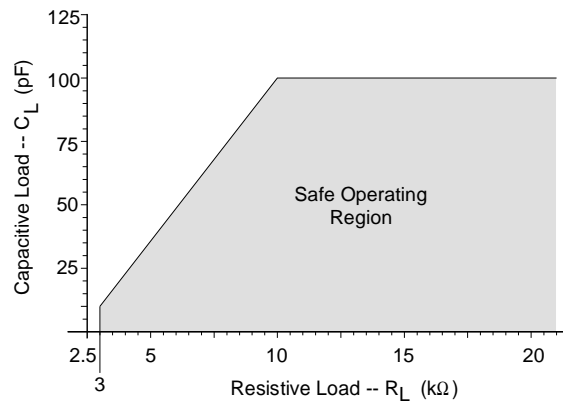
Figure 1. Output Test Load

Figure 2. Maximum Loading

COMBINED INTERPOLATION & ON-CHIP ANALOG FILTER RESPONSE (The filter characteristics and the X-axis of the response plots have been normalized to the sample rate (F_s) and can be referenced to the desired sample rate by multiplying the given characteristic by F_s .)

Parameter	Min	Typ	Max	Unit	
Single-Speed Mode - (4 kHz to 50 kHz sample rates)					
Passband	to -0.05 dB corner	0	-	0.4535	F_s
	to -3 dB corner	0	-	0.4998	F_s
Frequency Response 10 Hz to 20 kHz	-0.02	-	+0.08	dB	
StopBand	0.5465	-	-	F_s	
StopBand Attenuation (Note 4)	50	-	-	dB	
Group Delay	-	9/ F_s	-	s	
Passband Group Delay Deviation 0 - 20 kHz	-	$\pm 0.36/F_s$	-	s	
De-emphasis Error (Relative to 1 kHz) (Note 5)	$F_s = 32$ kHz	-	-	+0.2/-0.1	dB
	$F_s = 44.1$ kHz	-	-	+0.05/-0.14	dB
	$F_s = 48$ kHz	-	-	+0/-0.22	dB
Double-Speed Mode - (50 kHz to 100 kHz sample rates)					
Passband	to -0.1 dB corner	0	-	0.4621	F_s
	to -3 dB corner	0	-	0.4982	F_s
Frequency Response 10 Hz to 20 kHz	-0.06	-	+0.2	dB	
StopBand	0.577	-	-	F_s	
StopBand Attenuation (Note 4)	55	-	-	dB	
Group Delay	-	4/ F_s	-	s	
Passband Group Delay Deviation	0 - 40 kHz	-	$\pm 1.39/F_s$	-	s
	0 - 20 kHz	-	$\pm 0.23/F_s$	-	s

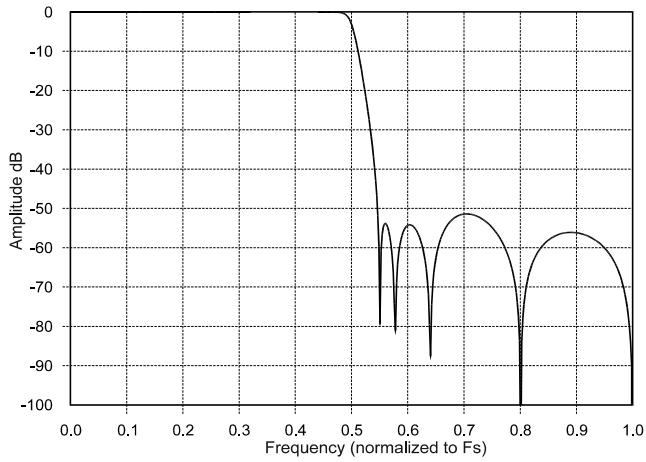
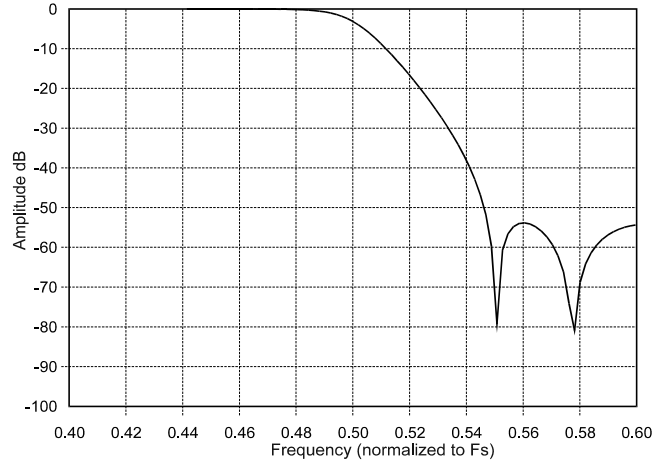
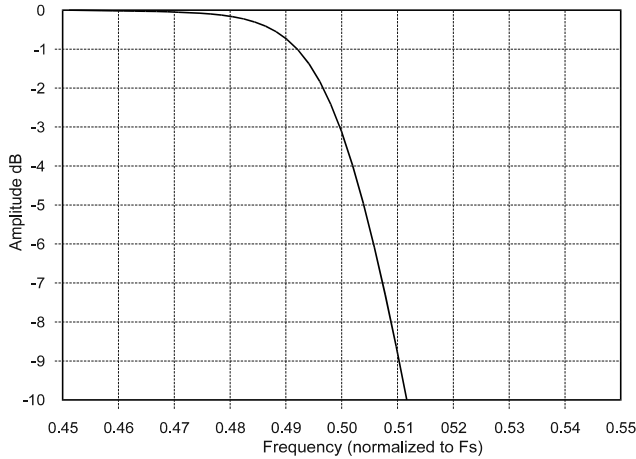
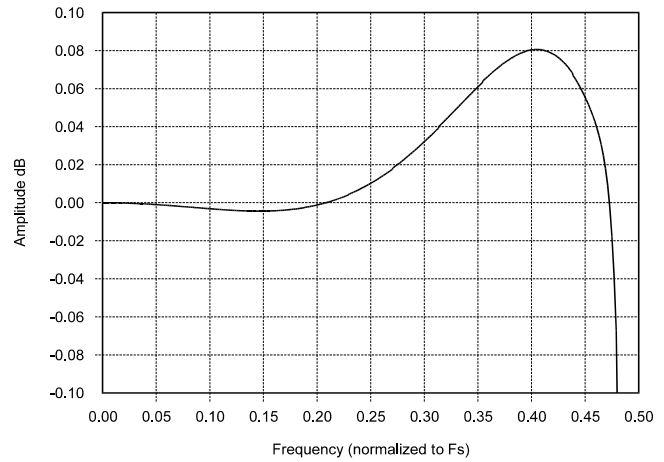
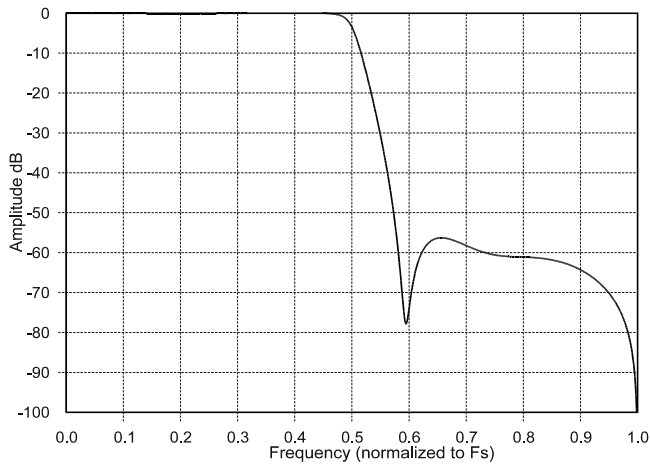
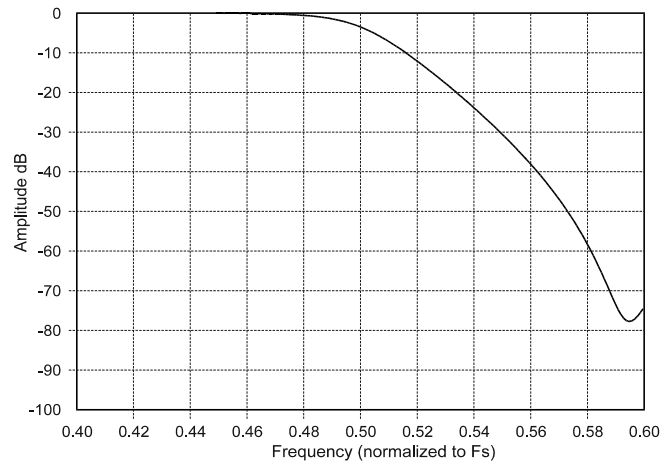
- Notes: 4. For Single-Speed Mode, the measurement bandwidth is 0.5465 F_s to 3 F_s .
For Double-Speed Mode, the measurement bandwidth is 0.577 F_s to 1.4 F_s .
5. De-emphasis is only available in Single-Speed Mode.

Figure 3. Single-Speed Stopband Rejection

Figure 4. Single-Speed Transition Band

Figure 5. Single-Speed Transition Band (Detail)

Figure 6. Single-Speed Passband Ripple

Figure 7. Double-Speed Stopband Rejection

Figure 8. Double-Speed Transition Band

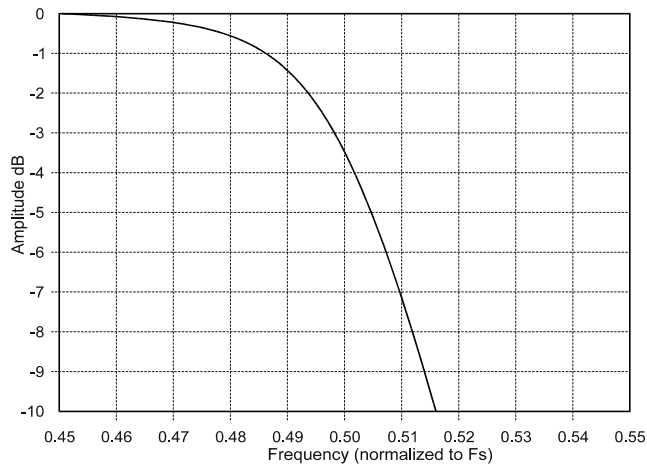

Figure 9. Double-Speed Transition Band (Detail)

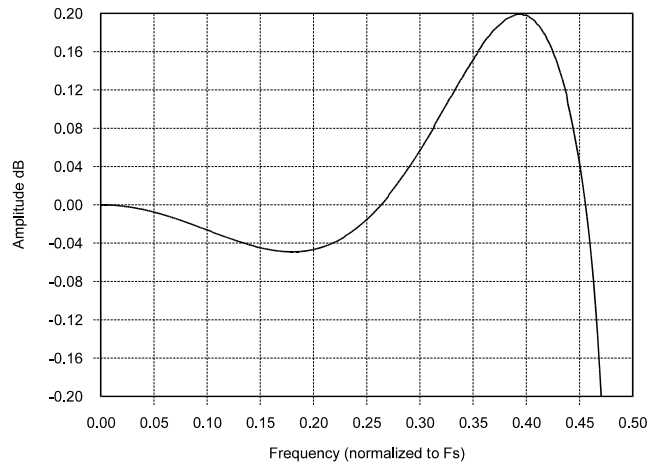
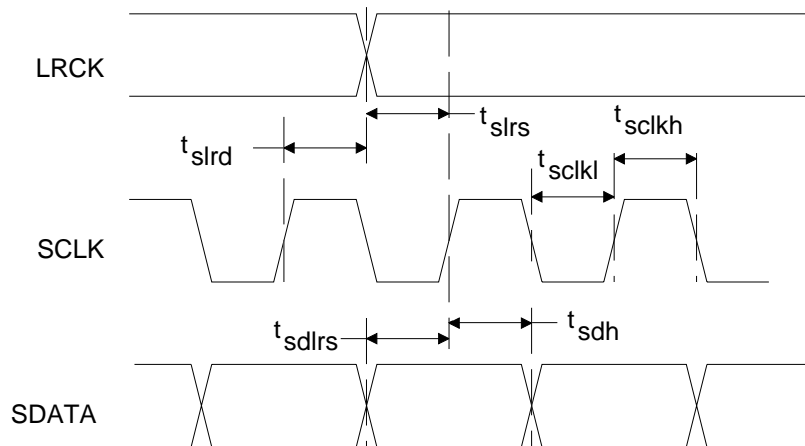

Figure 10. Double-Speed Passband Ripple

SWITCHING SPECIFICATIONS - SERIAL AUDIO INTERFACE

Parameters	Symbol	Min	Max	Units	
MCLK Frequency		1.024	51.2	MHz	
MCLK Duty Cycle		45	55	%	
Input Sample Rate	Single-Speed Mode	F_s	4	50	kHz
	Double-Speed Mode	F_s	50	100	kHz
LRCK Duty Cycle		40	60	%	
SCLK Pulse Width Low	t_{sckl}	20	-	ns	
SCLK Pulse Width High	t_{sckh}	20	-	ns	
SCLK Frequency	Single-Speed Mode	-	$128 \times F_s$	Hz	
	Double-Speed Mode	-	$64 \times F_s$	Hz	
SCLK rising to LRCK edge delay	t_{slrd}	20	-	ns	
SCLK rising to LRCK edge setup time	t_{slrs}	20	-	ns	
SDIN valid to SCLK rising setup time	t_{sdls}	20	-	ns	
SCLK rising to SDIN hold time	t_{sdh}	20	-	ns	

Figure 11. Serial Input Timing (External SCLK)

SWITCHING CHARACTERISTICS - INTERNAL SERIAL CLOCK

Parameters	Symbol	Min	Typ	Max	Units
MCLK Frequency		1.024	-	51.2	MHz
MCLK Duty Cycle		45	-	55	%
Input Sample Rate	Single-Speed Mode	F _s	-	50	kHz
	Double-Speed Mode	F _s	-	100	kHz
LRCK Duty Cycle		(Note 6)			%
SCLK Period	(Note 7) t _{sclkw}	$\frac{1}{\text{SCLK}}$	-	-	s
SCLK rising to LRCK edge	t _{sclkr}	-	$\frac{t_{\text{sclkw}}}{2}$	-	s
SDATA valid to SCLK rising setup time	t _{sdlrs}	$\frac{1}{(512)F_s} + 10$	-	-	ns
SCLK rising to SDATA hold time MCLK / LRCK = 512, 256 or 128	t _{sdh}	$\frac{1}{(512)F_s} + 15$	-	-	ns
SCLK rising to SDATA hold time MCLK / LRCK = 384 or 192	t _{sdh}	$\frac{1}{(384)F_s} + 15$	-	-	ns

Notes: 6. The Duty Cycle must be 50% +/- 1/2 MCLK Period.

7. See section 4.2.1 for derived internal frequencies.

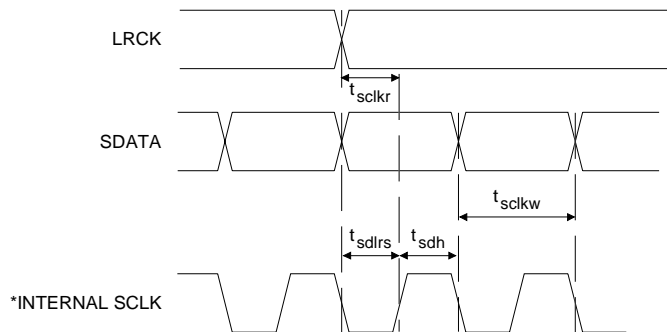

Figure 12. Internal Serial Mode Input Timing

*The SCLK pulses shown are internal to the CS4341.

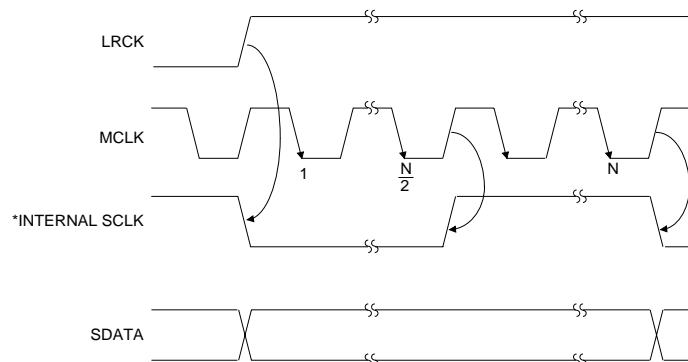

Figure 13. Internal Serial Clock Generation

* The SCLK pulses shown are internal to the CS4341. N equals MCLK divided by SCLK

SWITCHING CHARACTERISTICS - CONTROL PORT INTERFACE (I²C®)

Parameter	Symbol	Min	Max	Unit
I²C Mode				
SCL Clock Frequency	f_{scl}	-	100	kHz
RST Rising Edge to Start	t_{irs}	500	-	ns
Bus Free Time Between Transmissions	t_{buf}	4.7	-	μ s
Start Condition Hold Time (prior to first clock pulse)	t_{hdst}	4.0	-	μ s
Clock Low time	t_{low}	4.7	-	μ s
Clock High Time	t_{high}	4.0	-	μ s
Setup Time for Repeated Start Condition	t_{sust}	4.7	-	μ s
SDA Hold Time from SCL Falling (Note 8)	t_{hdd}	0	-	μ s
SDA Setup time to SCL Rising	t_{sud}	250	-	ns
Rise Time of SCL (Note 9)	t_{rc}	-	25	ns
Fall Time of SCL	t_{fc}	-	25	ns
Rise Time SDA	t_{rd}	-	1	μ s
Fall Time of SDA	t_{fd}	-	300	ns
Setup Time for Stop Condition	t_{susp}	4.7	-	μ s

Notes: 8. Data must be held for sufficient time to bridge the transition time, t_{fc} , of SCL.

9. See "Rise Time for Control Port Clock" on page 21 for a recommended circuit to meet rise time specification.

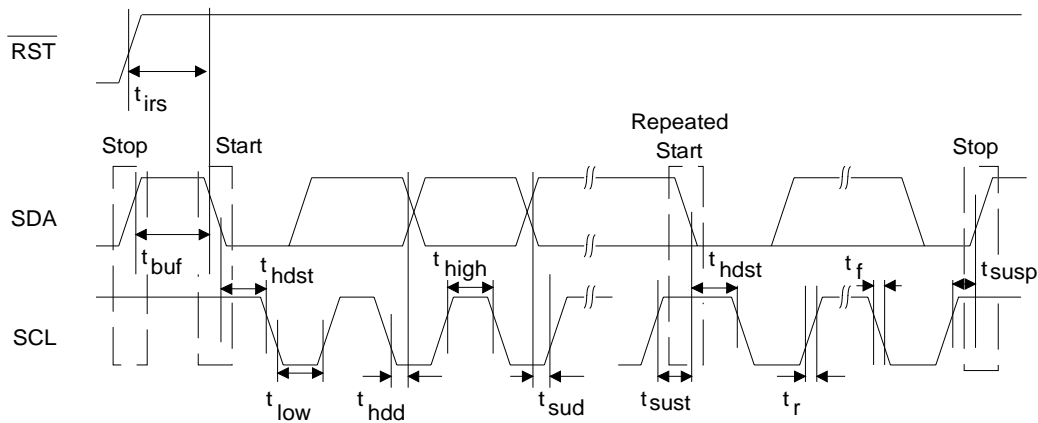

Figure 14. Control Port Timing - I²C Mode

SWITCHING CHARACTERISTICS - CONTROL PORT INTERFACE (SPI™)

Parameter	Symbol	Min	Max	Unit
SPI Mode				
CCLK Clock Frequency	f_{sclk}	-	6	MHz
\overline{RST} Rising Edge to \overline{CS} Falling	t_{srs}	500	-	ns
CCLK Edge to \overline{CS} Falling (Note 10)	t_{spi}	500	-	ns
\overline{CS} High Time Between Transmissions	t_{csh}	1.0	-	μ s
\overline{CS} Falling to CCLK Edge	t_{css}	20	-	ns
CCLK Low Time	t_{scl}	$\frac{1}{MCLK}$	-	ns
CCLK High Time	t_{sch}	$\frac{1}{MCLK}$	-	ns
CDIN to CCLK Rising Setup Time	t_{dsu}	40	-	ns
CCLK Rising to DATA Hold Time (Note 11)	t_{dh}	15	-	ns
Rise Time of CCLK and CDIN (Note 12)	t_{r2}	-	100	ns
Fall Time of CCLK and CDIN (Note 12)	t_{f2}	-	100	ns

Notes: 10. t_{spi} only needed before first falling edge of \overline{CS} after \overline{RST} rising edge. $t_{spi} = 0$ at all other times.

11. Data must be held for sufficient time to bridge the transition time of CCLK.

12. For $f_{sclk} < 1$ MHz.

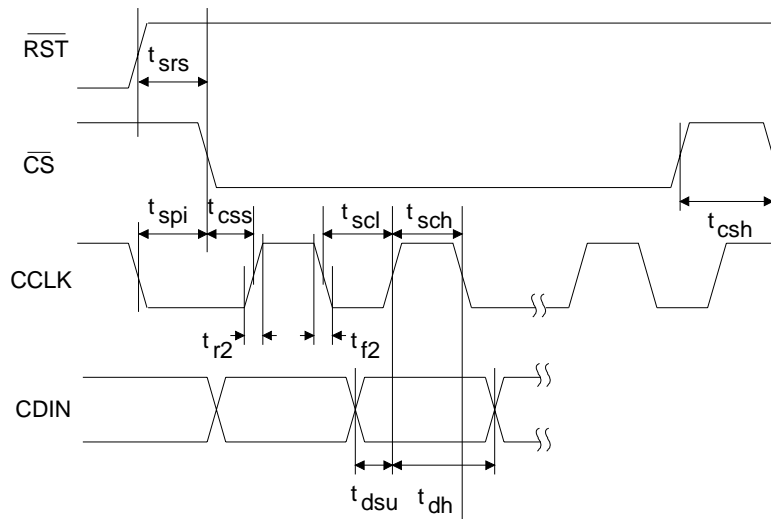

Figure 15. Control Port Timing - SPI Mode

DC ELECTRICAL CHARACTERISTICS (AGND = 0 V; all voltages with respect to AGND.)

Parameters	Symbol	Min	Typ	Max	Units	
Normal Operation (Note 13)						
Power Supply Current	VA = 5.0 V	IA	-	15	18	mA
	VA = 3.0 V	IA	-	11	14	mA
Power Dissipation	VA = 5.0 V		-	75	90	mW
	VA = 3.0 V		-	33	42	mW
Power-down Mode (Note 14)						
Power Supply Current	VA = 5.0 V	IA	-	60	-	μA
	VA = 3.0 V		-	30	-	μA
Power Dissipation	VA = 5.0 V		-	0.3	-	mW
	VA = 3.0 V		-	0.09	-	mW
All Modes of Operation						
Power Supply Rejection Ratio (Note 15)	1 kHz	PSRR	-	60	-	dB
	60 Hz		-	40	-	dB
VQ Nominal Voltage			-	0.45•VA	-	V
Output Impedance			-	250	-	kΩ
Maximum allowable DC current source/sink			-	0.01	-	mA
Filt+ Nominal Voltage			-	VA	-	V
Output Impedance			-	250	-	kΩ
Maximum allowable DC current source/sink			-	0.01	-	mA
MUTECLow-Level Output Voltage			-	0	-	V
MUTECHigh-Level Output Voltage			-	VA	-	V
Maximum MUTECL Drive Current			-	3	-	mA

- Notes: 13. Normal operation is defined as $\overline{RST} = HI$ with a 997 Hz, 0 dBFS input sampled at the highest Fs for each speed mode, and open outputs, unless otherwise specified.
14. Power Down Mode is defined as $\overline{RST} = LO$ with all clocks and data lines held static.
15. Valid with the recommended capacitor values on FILT+ and VQ as shown in Figure 16. Increasing the capacitance will also increase the PSRR.

DIGITAL INPUT CHARACTERISTICS (AGND = 0 V; all voltages with respect to AGND.)

Parameters	Symbol	Min	Typ	Max	Units
Input Leakage Current	I _{in}	-	-	±10	μA
Input Capacitance		-	8	-	pF

DIGITAL INTERFACE SPECIFICATIONS (AGND = 0 V; all voltages with respect to AGND.)

Parameters	Symbol	Min	Max	Units
3.3 V Logic (3.0 V to 3.6 V DC Supply)				
High-Level Input Voltage	V _{IH}	2.0	-	V
Low-Level Input Voltage	V _{IL}	-	0.8	V
5.0 V Logic (4.75 V to 5.25 V DC Supply)				
High-Level Input Voltage	V _{IH}	2.0	-	V
Low-Level Input Voltage	V _{IL}	-	0.8	V

2. PIN DESCRIPTION

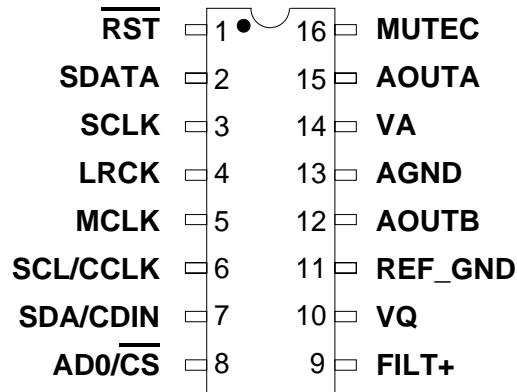

Pin Name	#	Pin Description
$\overline{\text{RST}}$	1	Reset (Input) - Powers down device and resets registers to their default settings.
SDATA	2	Serial Audio Data (Input) - Input for two's complement serial audio data.
SCLK	3	Serial Clock (Input) - Serial clock for the serial audio interface.
LRCK	4	Left Right Clock (Input) - Determines which channel, Left or Right, is currently active on the serial audio data line.
MCLK	5	Master Clock (Input) - Clock source for the delta-sigma modulator and digital filters.
SCL/CCLK	6	Serial Control Port Clock (Input) - Serial clock for the control port interface.
SDA/CDIN	7	Serial Control Data I/O (Input/Output) - Input/Output for I ² C data. Input for SPI data.
$\overline{\text{AD0/CS}}$	8	Address Bit / Chip Select (Input) - Chip address bit in I ² C Mode. Control signal used to select the chip in SPI mode.
FILT+	9	Positive Voltage Reference (Output) - Positive voltage reference for the internal sampling circuits.
VQ	10	Quiescent Voltage (Output) - Filter connection for internal quiescent reference voltage.
REF_GND	11	Reference Ground (Input) - Ground reference for the internal sampling circuits.
AOUTB AOUTA	12 15	Analog Outputs (Output) - The full-scale analog output level is specified in the <i>Analog Characteristics</i> table.
AGND	13	Analog Ground (Input)
VA	14	Power (Input) - Positive power for the analog, digital, and serial audio interface sections.
MUTE	16	Mute Control (Output) - Control signal for an optional mute circuit.

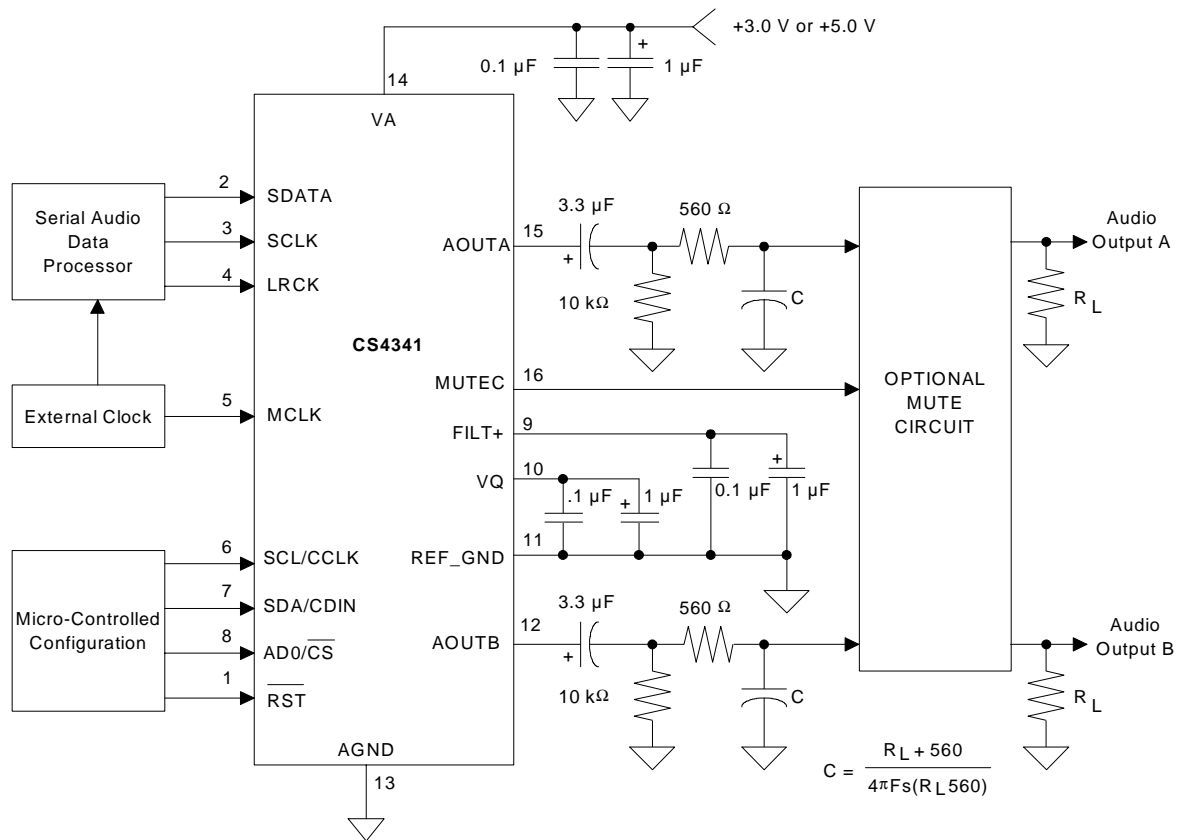
3. TYPICAL CONNECTION DIAGRAM

Figure 16. Typical Connection Diagram

4. APPLICATIONS

4.1 Sample Rate Range/Operational Mode

The device operates in one of two operational modes determined by the Master Clock to Left/Right Clock ratio (see section 4.2). Sample rates outside the specified range for each mode are not supported.

Input Sample Rate (Fs)	MODE
4 kHz - 50 kHz	Single-Speed Mode
50 kHz - 100 kHz	Double-Speed Mode

Table 1. CS4341 Speed Modes

4.2 System Clocking

The device requires external generation of the master (MCLK) and left/right (LRCK) clocks. The device also requires external generation of the serial clock (SCLK) if the internal serial clock is not used. The LRCK, defined also as the input sample rate Fs, must be synchronously derived from MCLK according to specified ratios. The specified ratios of MCLK to LRCK, along with several standard audio sample rates and the required MCLK frequency, are illustrated in Tables 2 and 3.

Sample Rate (kHz)	MCLK (MHz)				
	256x	384x	512x	768x*	1024x*
32	8.1920	12.2880	16.3840	24.5760	32.768
44.1	11.2896	16.9344	22.5792	33.8688	45.1584
48	12.2880	18.4320	24.5760	36.8640	49.1520

Table 2. Single-Speed Mode Standard Frequencies

Sample Rate (kHz)	MCLK (MHz)			
	128x	192x	256x*	384x*
64	8.1920	12.2880	16.3840	24.5760
88.2	11.2896	16.9344	22.5792	33.8688
96	12.2880	18.4320	24.5760	36.8640

Table 3. Double-Speed Mode Standard Frequencies

*Requires MCLKDIV bit = 1 in the MCLK Control (address 00h) register.

4.2.1 Internal Serial Clock Mode

The device will enter the Internal Serial Clock Mode if no low to high transitions are detected on the SCLK pin for 2 consecutive periods of LRCK. In this mode, the SCLK is internally derived and synchronous with MCLK and LRCK. The SCLK/LRCK ratio is either 32, 48, or 64 depending upon the MCLK/LRCK ratio and the Digital Interface Format selection (see Table 4).

Operation in the Internal Serial Clock mode is identical to operation with an external SCLK synchronized with LRCK; however, External SCLK mode is recommended for system clocking applications.

Input MCLK/LRCK Ratio	Digital Interface Format Selection				Internal SCLK/LRCK Ratio
	I ² S up to 16 or 24 Bits	Left Justified 24 Bits	Right Justified 18, 20 or 24 Bits	Right Justified 16 Bits	
512, 256, 128	(Format 1)	-	-	X	32
384, 192	X	X	X	X	48
512, 256, 128	(Format 0)	X	X	-	64

Table 4. Internal SCLK/LRCK Ratio

4.2.2 External Serial Clock Mode

The device will enter the External Serial Clock Mode whenever 16 low to high transitions are detected on the SCLK pin during any phase of the LRCK period. The device will revert to Internal Serial Clock Mode if no low to high transitions are detected on the SCLK pin for 2 consecutive periods of LRCK.

4.3 Digital Interface Format

The device will accept audio samples in several digital interface formats. The desired format is selected via the DIF0, DIF1 and DIF2 bits in the Mode Control register (see section 6.2.2). For an illustration of the required relationship between LRCK, SCLK and SDATA, see Figures 17 through 19.

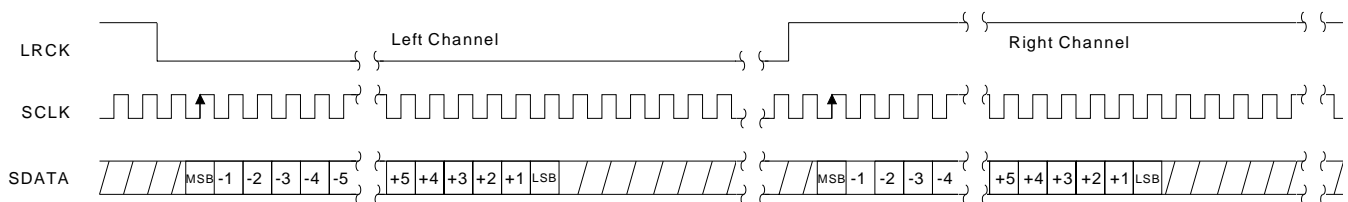
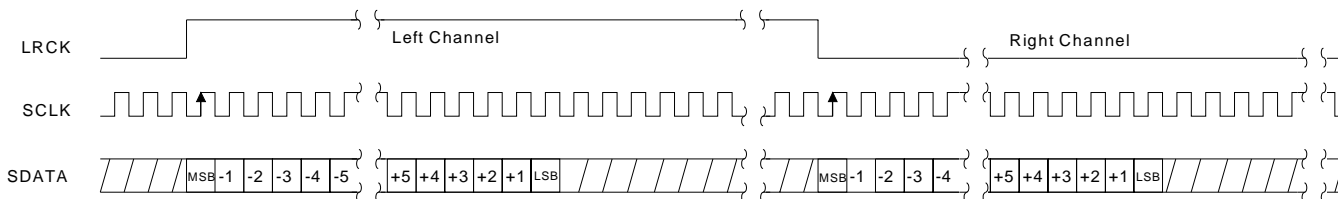
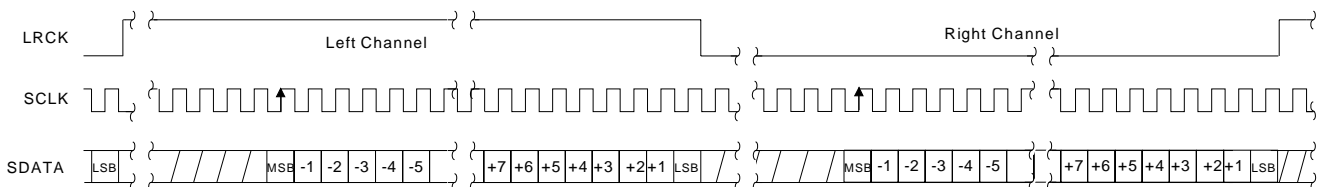
Figure 17. CS4341 Formats 0-1 - I²S up to 24-Bit Data

Figure 18. CS4341 Format 2 - Left Justified up to 24-Bit Data

Figure 19. CS4341 Formats 3-6 - Right Justified

4.4 De-Emphasis

The device includes on-chip digital de-emphasis. The Mode Control (address 01h) bits select either the 32, 44.1 or 48 kHz de-emphasis filter. Figure 20 shows the de-emphasis curve for F_s equal to 44.1 kHz. The frequency response of the de-emphasis curve will scale proportionally with changes in sample rate, F_s . Please see section 6.2.3 for the desired de-emphasis control.

De-emphasis is only available in Single-Speed Mode.

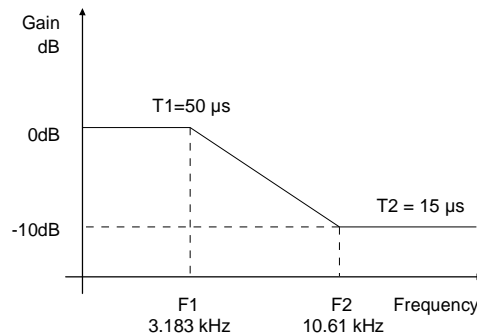

Figure 20. De-Emphasis Curve

4.5 Power-Up Sequence

- 1) Hold \overline{RST} low until the power supply is stable, and the master and left/right clocks are locked to the appropriate frequencies, as discussed in section 4.2. In this state, the control port is reset to its default settings and VQ will remain low.
- 2) Bring \overline{RST} high. The device will remain in a low power state with VQ low.
- 3) Load the desired register settings while keeping the PDN bit set to 1.
- 4) Set the PDN bit to 0. This will initiate the power-up sequence, which lasts approximately 50 μ S when the POR bit is set to 0. If the POR bit is set to 1, see section 4.6 for a complete description of power-up timing.

4.6 Popguard® Transient Control

The CS4341 uses Popguard® technology to minimize the effects of output transients during power-up and power-down. This technology, when used with external DC-blocking capacitors in series with the audio outputs, minimizes the audio transients commonly produced by single-ended single-supply converters. It is activated inside the DAC when \overline{RST} is enabled/disabled and requires no other external control, aside from choosing the appropriate DC-blocking capacitors.

4.6.1 Power-Up

When the device is initially powered-up, the audio outputs, AOUTL and AOUTR, are clamped to AGND. Following a delay of approximately 1000 sample periods, each output begins to ramp toward the quiescent voltage. Approximately 10,000 LRCK cycles later, the outputs reach V_Q and audio output begins. This gradual voltage ramping allows time for the external DC-blocking capacitors to charge to the quiescent voltage, minimizing the power-up transient.

4.6.2 Power-Down

To prevent transients at power-down, the device must first enter its power-down state by enabling $\overline{\text{RST}}$ or setting the PDN bit. When this occurs, audio output ceases and the internal output buffers are disconnected from AOUTL and AOUTR. In their place, a soft-start current sink is substituted which allows the DC-blocking capacitors to slowly discharge. Once this charge is dissipated, the power to the device may be turned off and the system is ready for the next power-on.

4.6.3 Discharge Time

To prevent an audio transient at the next power-on, it is necessary to ensure that the DC-blocking capacitors have fully discharged before turning on the power or exiting the power-down state. If not, a transient will occur when the audio outputs are initially clamped to AGND. The time that the device must remain in the power-down state is related to the value of the DC-blocking capacitance. For example, with a 3.3 μF capacitor, the minimum power-down time will be approximately 0.4 seconds.

4.7 Mute Control

The Mute Control pin goes high during power-up initialization, reset, muting (see section 6.2.1 and 6.5.1) or if the MCLK to LRCK ratio is incorrect. This pin is intended to be used as a control for an external mute circuit to prevent the clicks and pops that can occur in any single-ended single supply system.

Use of the Mute Control function is not mandatory but recommended for designs requiring the absolute minimum in extraneous clicks and pops. Also, use of the Mute Control function can enable the system designer to achieve idle channel noise/signal-to-noise ratios which are only limited by the external mute circuit. See the CDB4341 data sheet for a suggested mute circuit.

4.8 Grounding and Power Supply Arrangements

As with any high resolution converter, the CS4341 requires careful attention to power supply and grounding arrangements if its potential performance is to be realized. Figure 16 shows the recommended power arrangements, with VA connected to a clean supply. If the ground planes are split between digital ground and analog ground, REF_GND & AGND should be connected to the analog ground plane.

Decoupling capacitors should be as close to the DAC as possible, with the low value ceramic capacitor being the closest. To further minimize impedance, these capacitors should be located on the same layer as the DAC.

All signals, especially clocks, should be kept away from the FILT+ and VQ pins in order to avoid unwanted coupling into the modulators. The FILT+ and VQ decoupling capacitors, particularly the 0.1 μF , must be positioned to minimize the electrical path from FILT+ and REF_GND (as well as VQ and REF_GND), and should also be located on the same layer as the DAC. The CDB4341 evaluation board demonstrates the optimum layout and power supply arrangements.

4.9 Control Port Interface

The control port is used to load all the internal register settings (see section 6). The operation of the control port may be completely asynchronous with the audio sample rate. However, to avoid potential interference problems, the control port pins should remain static if no operation is required.

The control port operates in one of two modes: I²C or SPI.

Notes: MCLK must be applied during all I²C communication.

4.9.1 Rise Time for Control Port Clock

When excess capacitive loading is present on the I²C clock line, pin 6 (SCL/CCLK) may not have sufficient hysteresis to meet the standard I²C rise time specification. This prevents the use of common I²C configurations with a resistor pull-up. A workaround is achieved by placing a Schmitt Trigger buffer, a 74HC14 for example, on the SCL line just prior to the CS4341. This will not affect the operation of the I²C bus as pin 6 is an input only.

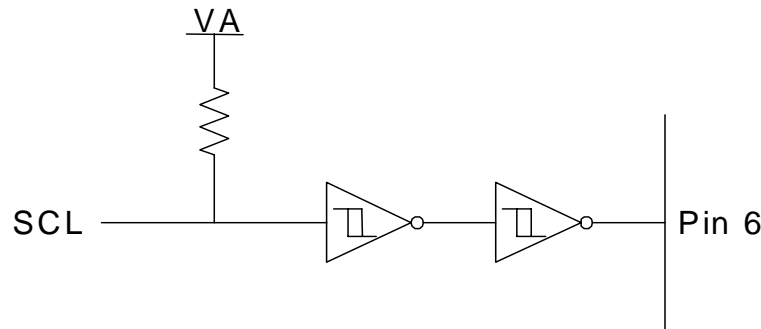

Figure 21. I²C Buffer Example

4.9.2 Memory Address Pointer (MAP)

The MAP byte precedes the control port register byte during a write operation and is not available again until after a start condition is initiated. During a read operation the byte transmitted after the ACK will contain the data of the register pointed to by the MAP (see section 4.9.3 for write/read details).

7	6	5	4	3	2	1	0
INCR	Reserved	Reserved	Reserved	MAP3	MAP2	MAP1	MAP0
0	0	0	0	0	0	0	0

4.9.2a INCR (Auto Map Increment)

The device has a MAP auto increment capability enabled by the INCR bit (the MSB) of the MAP. If INCR is set to 0, MAP will stay constant for successive I²C writes or reads and SPI writes. If INCR is set to 1, MAP will auto increment after each byte is written, allowing block reads or writes of successive registers.

Default = '0'
 0 - Disabled
 1 - Enabled

4.9.2b MAP0-3 (Memory Address Pointer)

Default = '0000'

4.9.3 I²C Mode

In the I²C Mode, data is clocked into and out of the bi-directional serial control data line, SDA, by the serial control port clock, SCL. There is no CS pin. Pin AD0 enables the user to alter the chip address (001000[AD0][R/W]) and should be tied to VA or AGND as required, before powering up the device. If the device ever detects a high to low transition on the AD0/CS pin after power-up, SPI mode will be selected.

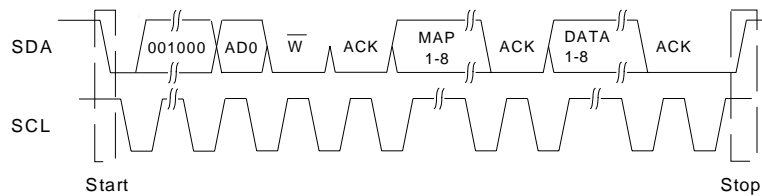

Figure 22. I²C Write

4.9.3a I²C Write

To write to the device, follow the procedure below while adhering to the control port Switching Specifications in section 6.

- 1) Initiate a START condition to the I²C bus followed by the address byte. The upper 6 bits must be 001000. The seventh bit must match the setting of the AD0 pin, and the eighth must be 0. The eighth bit of the address byte is the R/W bit.
- 2) Wait for an acknowledge (ACK) from the part, then write to the memory address pointer, MAP. This byte points to the register to be written.
- 3) Wait for an acknowledge (ACK) from the part, then write the desired data to the register pointed to by the MAP.
- 4) If the INCR bit (see section 4.9.2a) is set to 1, repeat the previous step until all the desired registers are written, then initiate a STOP condition to the bus.
- 5) If the INCR bit is set to 0 and further I²C writes to other registers are desired, it is necessary to repeat the procedure detailed from step 1. If no further writes to other registers are desired, initiate a STOP condition to the bus.

4.9.3b I²C Read

To read from the device, follow the procedure below while adhering to the control port Switching Specifications. During this operation it is first necessary to write to the device, specifying the appropriate register through the MAP.

- 1) After writing to the MAP (see section 4.9.3a), initiate a repeated START condition to the I²C bus followed by the address byte. The upper 6 bits must be 001000. The seventh bit must match the setting of the AD0 pin, and the eighth must be 1. The eighth bit of the address byte is the R/W bit.
- 2) Signal the end of the address byte by *not* issuing an acknowledge. The device will then transmit the contents of the register pointed to by the MAP. The MAP will contain the address of the last register written to the MAP.
- 3) If the INCR bit is set to 1, the device will continue to transmit the contents of successive registers. Continue providing a clock but do not issue an ACK on the bytes clocked out of the device. After all the desired registers are read, initiate a STOP condition to the bus.
- 4) If the INCR bit is set to 0 and further I²C reads from other registers are desired, it is necessary to repeat the procedure detailed from step 1. If no further reads from other registers are desired, initiate a STOP condition to the bus.

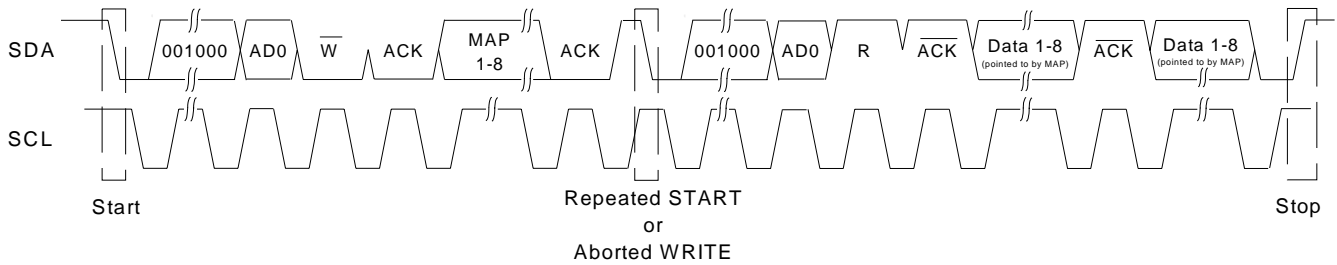
Figure 23. I²C Read

4.9.4 SPI Mode

In SPI mode, data is clocked into the serial control data line, CDIN, by the serial control port clock, CCLK (see Figure 24 for the clock to data relationship). There is no AD0 pin. Pin \overline{CS} is the chip select signal and is used to control SPI writes to the control port. When the device detects a high to low transition on the AD0/ \overline{CS} pin after power-up, SPI mode will be selected. All signals are inputs and data is clocked in on the rising edge of CCLK.

4.9.4a SPI Write

To write to the device, follow the procedure below while adhering to the control port Switching Specifications in section 1.

- 1) Bring \overline{CS} low.
- 2) The address byte on the CDIN pin must then be 00100000.
- 3) Write to the memory address pointer, MAP. This byte points to the register to be written.
- 4) Write the desired data to the register pointed to by the MAP.
- 5) If the INCR bit (see section 4.9.2a) is set to 1, repeat the previous step until all the desired registers are written, then bring \overline{CS} high.
- 6) If the INCR bit is set to 0 and further SPI writes to other registers are desired, it is necessary to bring \overline{CS} high, and repeat the procedure detailed from step 1. If no further writes to other registers are desired, bring \overline{CS} high.

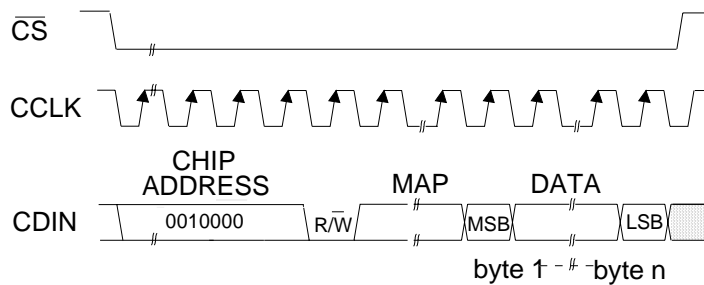

MAP = Memory Address Pointer

Figure 24. Control Port Timing, SPI Mode

5. REGISTER QUICK REFERENCE

Addr	Function	7	6	5	4	3	2	1	0
0h	MCLK Control DEFAULT	Reserved 0	Reserved 0	Reserved 0	Reserved 0	Reserved 0	Reserved 0	MCLKDIV 0	Reserved 0
1h	Mode Control 2 DEFAULT	AMUTE 1	DIF2 0	DIF1 0	DIF0 0	DEM1 0	DEM1 0	POR 1	PDN 1
2h	Transition and Mixing Control DEFAULT	A = B 0	SCZ1 0	SCZ0 0	ATAPI4 0	ATAPI3 0	ATAPI2 0	ATAPI1 0	ATAPI0 0
3h	Channel A Volume Control DEFAULT	MUTEA 0	VOLA6 0	VOLA5 0	VOLA4 0	VOLA3 0	VOLA2 0	VOLA1 0	VOLA0 0
4h	Channel B Volume Control DEFAULT	MUTEB 0	VOLB6 0	VOLB5 0	VOLB4 0	VOLB3 0	VOLB2 0	VOLB1 0	VOLB0 0

6. REGISTER DESCRIPTION

NOTE: All registers are read/write in I²C Mode and write only in SPI mode, unless otherwise stated.

6.1 MCLK CONTROL (ADDRESS 00H)

7	6	5	4	3	2	1	0
Reserved	Reserved	Reserved	Reserved	Reserved	Reserved	MCLKDIV	Reserved
0	0	0	0	0	0	0	0

6.1.1 MCLK DIVIDE-BY-2 (MCLKDIV) BIT 1

Default = 0

0 - Disabled

1 - Enabled

Function:

The MCLKDIV bit enables a circuit which divides the externally applied MCLK signal by 2.

6.2 MODE CONTROL (ADDRESS 01H)

7	6	5	4	3	2	1	0
AMUTE	DIF2	DIF1	DIF0	DEM1	DEM0	POR	PDN
1	0	0	0	0	0	1	1

6.2.1 AUTO-MUTE (AMUTE) BIT 7

Default = 1

0 - Disabled

1 - Enabled

Function:

The Digital-to-Analog converter output will mute following the reception of 8192 consecutive audio samples of static 0 or -1. A single sample of non-zero data will release the mute. Detection and muting is done independently for each channel. The quiescent voltage on the output will be retained and the Mute Control pin will go active during the mute period. The muting function is affected, similar to volume control changes, by the Soft and Zero Cross bits in the Transition and Mixing Control (address 02h) register.

6.2.2 DIGITAL INTERFACE FORMAT (DIF) BIT 4-6

Default = 000 - Format 0 (I²S, up to 24-bit data, 64 x Fs Internal SCLK)

Function:

The required relationship between the Left/Right clock, serial clock and serial data is defined by the Digital Interface Format and the options are detailed in Figures 17 through 19.

DIF2	DIF1	DIF0	DESCRIPTION	Format	FIGURE
0	0	0	I ² S, up to 24-bit data, 64Fs Internal SCLK	0	17
0	0	1	I ² S, up to 16-bit data, 32Fs Internal SCLK	1	17
0	1	0	Left Justified, up to 24-bit data,	2	18
0	1	1	Right Justified, 24-bit data	3	19
1	0	0	Right Justified, 20-bit data	4	19
1	0	1	Right Justified, 16-bit data	5	19
1	1	0	Right Justified, 18-bit data	6	19
1	1	1	Identical to Format 1	1	17

Table 5. Digital Interface Format

6.2.3 DE-EMPHASIS CONTROL (DEM) BIT 2-3

Default = 00
 00 - Disabled
 01 - 44.1 kHz
 10 - 48 kHz
 11 - 32 kHz

Function:

Implementation of the standard 15µs/50µs digital de-emphasis filter response, Figure 20, requires re-configuration of the digital filter to maintain the proper filter response for 32, 44.1 or 48 kHz sample rates.

NOTE: De-emphasis is only available in Single-Speed Mode.

6.2.4 POPGUARD® TRANSIENT CONTROL (POR) BIT 1

Default = 1
 0 - Disabled
 1 - Enabled

Function:

The Popguard® Transient Control allows the quiescent voltage to slowly ramp to and from 0 volts to the quiescent voltage during power-on or power-down. Please refer to section 4.6 for implementation details.

6.2.5 POWER DOWN (PDN) BIT 0

Default = 1
 0 - Disabled
 1 - Enabled

Function:

The device will enter a low-power state when this function is enabled. The power-down bit defaults to 'enabled' on power-up and must be disabled before normal operation can occur. The contents of the control registers are retained in this mode.

6.3 TRANSITION AND MIXING CONTROL (ADDRESS 02H)

7	6	5	4	3	2	1	0
A = B	SZC1	SZC0	ATAPI4	ATAPI3	ATAPI2	ATAPI1	ATAPI0
0	1	0	0	1	0	0	1

6.3.1 CHANNEL A VOLUME = CHANNEL B VOLUME (A = B) BIT 7

Default = 0

0 - Disabled

1 - Enabled

Function:

The AOUTA and AOUTB volume levels are independently controlled by the A and the B Channel Volume Control Bytes when this function is disabled. The volume on both AOUTA and AOUTB are determined by the A Channel Volume Control Byte and the B Channel Byte is ignored when this function is enabled.

6.3.2 SOFT RAMP AND ZERO CROSS CONTROL (SZCX) BIT 5-6

Default = 10

00 - Immediate Changes

01 - Changes On Zero Crossings

10 - Soft Ramped Changes

11 - Soft Ramped Changes On Zero Crossings

Function:

Immediate Changes

When *Immediate Changes* is selected all level changes will take effect immediately in one step.

Changes On Zero Crossings

Changes on Zero Crossings dictates that signal level changes, either by attenuation changes or muting, will occur on a signal zero crossing to minimize audible artifacts. The requested level change will occur after a timeout period between 512 and 1024 sample periods (10.7 ms to 21.3 ms at 48 kHz sample rate) if the signal does not encounter a zero crossing. The zero cross function is independently monitored and implemented for each channel.

Soft Ramped Changes

Soft Ramped Changes allows level changes, both muting and attenuation, to be implemented by incrementally ramping, in 1/8 dB steps, from the current level to the new level at a rate of 1dB per 8 left/right clock periods.

Soft Ramped Changes on Zero Crossings

Soft Ramped Changes On Zero Crossings dictates that signal level changes, either by attenuation changes or muting, will occur in 1/8 dB steps implemented on a signal zero crossing. The 1/8 dB level change will occur after a timeout period between 512 and 1024 sample periods (10.7 ms to 21.3 ms at 48 kHz sample rate) if the signal does not encounter a zero crossing. The zero cross function is independently monitored and implemented for each channel.

6.3.3 ATAPI CHANNEL MIXING AND MUTING (ATAPI) BIT 0-4

Default = 01001 - AOUTA = Left Channel, AOUTB = Right Channel (Stereo)

Function:

The CS4341 implements the channel mixing functions of the ATAPI CD-ROM specification. Refer to Table 6 and Figure 25 for additional information.

ATAPI4	ATAPI3	ATAPI2	ATAPI1	ATAPI0	AOUTA	AOUTB
0	0	0	0	0	MUTE	MUTE
0	0	0	0	1	MUTE	bR
0	0	0	1	0	MUTE	bL
0	0	0	1	1	MUTE	b[(L+R)/2]
0	0	1	0	0	aR	MUTE
0	0	1	0	1	aR	bR
0	0	1	1	0	aR	bL
0	0	1	1	1	aR	b[(L+R)/2]
0	1	0	0	0	aL	MUTE
0	1	0	0	1	aL	bR
0	1	0	1	0	aL	bL
0	1	0	1	1	aL	b[(L+R)/2]
0	1	1	0	0	a[(L+R)/2]	MUTE
0	1	1	0	1	a[(L+R)/2]	bR
0	1	1	1	0	a[(L+R)/2]	bL
0	1	1	1	1	a[(L+R)/2]	b[(L+R)/2]
1	0	0	0	0	MUTE	MUTE
1	0	0	0	1	MUTE	bR
1	0	0	1	0	MUTE	bL
1	0	0	1	1	MUTE	bL/2
1	0	1	0	0	aR	MUTE
1	0	1	0	1	aR	bR
1	0	1	1	0	aR	bL
1	0	1	1	1	aR	[(aR+bL)/2]
1	1	0	0	0	aL	MUTE
1	1	0	0	1	aL	bR
1	1	0	1	0	aL	bL
1	1	0	1	1	aL	[(aL+bR)/2]
1	1	1	0	0	aL/2	MUTE
1	1	1	0	1	[(aL+bR)/2]	bR
1	1	1	1	0	[(bL+aR)/2]	bL
1	1	1	1	1	[(aL+bR)/2]	[(aL+bR)/2]

Table 6. ATAPI Decode

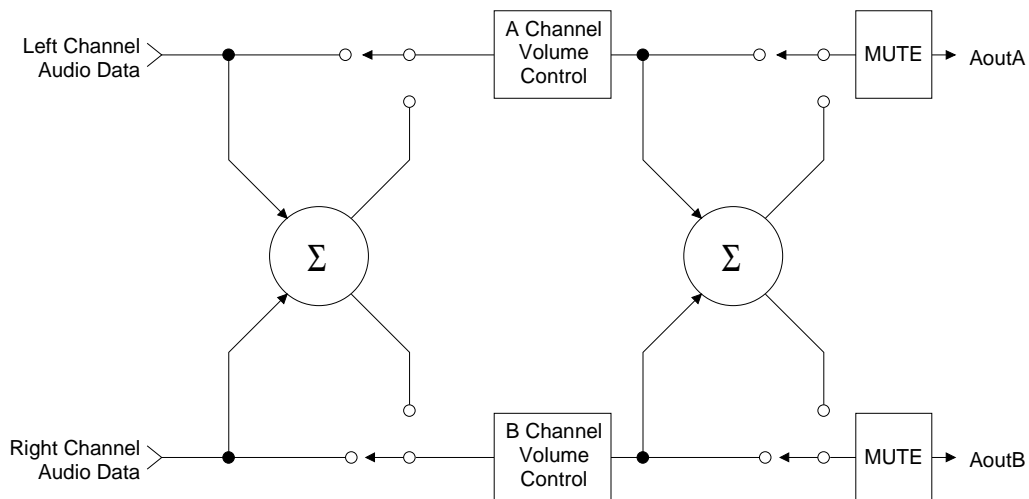

Figure 25. ATAPI Block Diagram

6.4 CHANNEL A VOLUME CONTROL (ADDRESS 03H)

Same as CHANNEL B Volume Control.

6.5 CHANNEL B VOLUME CONTROL (ADDRESS 04H)

7	6	5	4	3	2	1	0
MUTEx	VOLx6	VOLx5	VOLx4	VOLx3	VOLx2	VOLx1	VOLx0
0	0	0	0	0	0	0	0

6.5.1 MUTE (MUTE) BIT 7

Default = 0

0 - Disabled

1 - Enabled

Function:

The Digital-to-Analog converter output will mute when enabled. The quiescent voltage on the output will be retained. The muting function is affected, similar to attenuation changes, by the Soft and Zero Cross bits in the Transition and Mixing Control (address 02h) register. The MUTEC will go active during the mute period if the Mute function is enabled for both channels.

6.5.2 VOLUME (VOLx) BIT 0-6

Default = 0 dB (No Attenuation)

Function:

The digital volume control allows the user to attenuate the signal in 1 dB increments from 0 to -90 dB. Volume settings are decoded as shown in Table 7. The volume changes are implemented as dictated by the Soft and Zero Cross bits in the Transition and Mixing Control (address 02h) register. All volume settings less than -94 dB are equivalent to enabling the Mute bit.

Binary Code	Decimal Value	Volume Setting
0000000	0	0 dB
0010100	20	-20 dB
0101000	40	-40 dB
0111100	60	-60 dB
1011010	90	-90 dB

Table 7. Example Digital Volume Settings

7. PARAMETER DEFINITIONS

Total Harmonic Distortion + Noise (THD+N)

The ratio of the rms value of the signal to the rms sum of all other spectral components over the specified bandwidth (typically 10 Hz to 20 kHz), including distortion components. Expressed in decibels.

Dynamic Range

The ratio of the full-scale rms value of the signal to the rms sum of all other spectral components over the specified bandwidth. Dynamic range is a signal-to-noise measurement over the specified bandwidth made with a -60 dBFS signal. 60 dB is then added to the resulting measurement to refer the measurement to full scale. This technique ensures that the distortion components are below the noise level and do not affect the measurement. This measurement technique has been accepted by the Audio Engineering Society, AES17-1991, and the Electronic Industries Association of Japan, EIAJ CP-307.

Interchannel Isolation

A measure of crosstalk between the left and right channels. Measured for each channel at the converter's output with all zeros to the input under test and a full-scale signal applied to the other channel. Units in decibels.

Interchannel Gain Mismatch

The gain difference between left and right channels. Units in decibels.

Gain Error

The deviation from the nominal full-scale analog output for a full-scale digital input.

Gain Drift

The change in gain value with temperature. Units in ppm/°C.

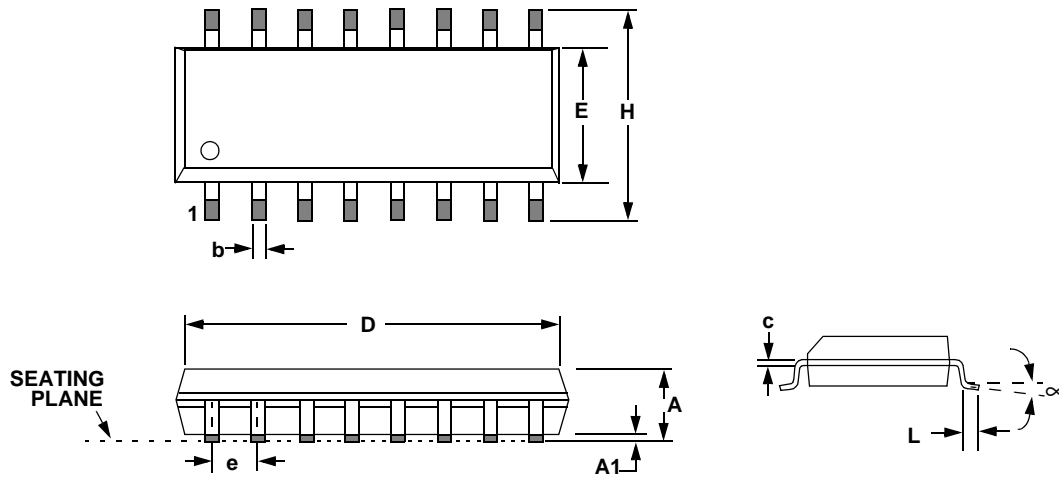
8. PACKAGE DIMENSIONS
8.1 SOIC
16L SOIC (150 MIL BODY) PACKAGE DRAWING

DIM	INCHES			MILLIMETERS		
	MIN	NOM	MAX	MIN	NOM	MAX
A	0.053	0.064	0.069	1.35	1.63	1.75
A1	0.004	0.006	0.010	0.10	0.15	0.25
b	0.013	0.016	0.020	0.33	0.41	0.51
C	0.0075	0.008	0.010	0.19	0.20	0.25
D	0.386	0.390	0.394	9.80	9.91	10.00
E	0.150	0.154	0.157	3.80	3.90	4.00
e	0.040	0.050	0.060	1.02	1.27	1.52
H	0.228	0.236	0.244	5.80	6.0	6.20
L	0.016	0.025	0.050	0.40	0.64	1.27
∞	0°	4°	8°	0°	4°	8°

JEDEC #: MS-012

Controlling Dimension is Millimeters

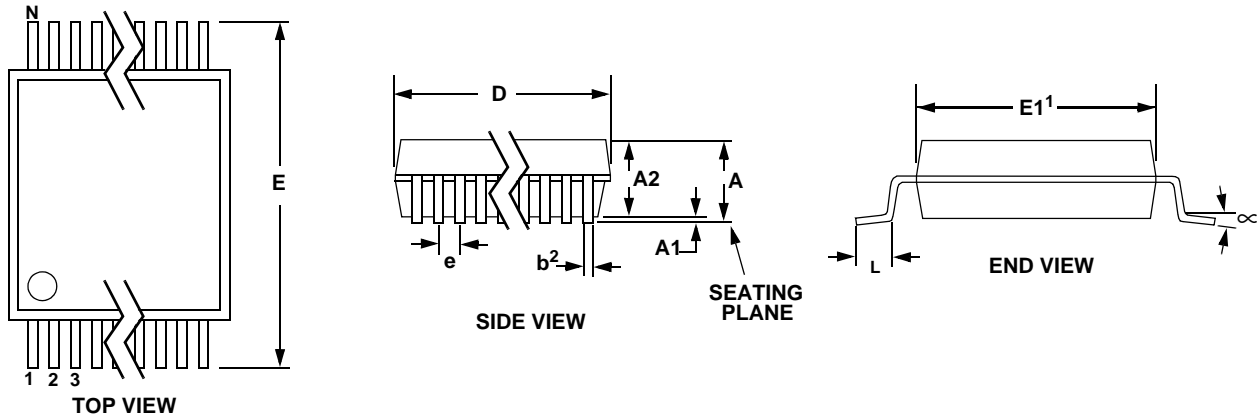
8.2 TSSOP
16L TSSOP (4.4 mm BODY) PACKAGE DRAWING

DIM	INCHES			MILLIMETERS			NOTE
	MIN	NOM	MAX	MIN	NOM	MAX	
A	--	--	0.043	--	--	1.10	
A1	0.002	0.004	0.006	0.05	--	0.15	
A2	0.03346	0.0354	0.037	0.85	0.90	0.95	
b	0.00748	0.0096	0.012	0.19	0.245	0.30	2,3
D	0.193	0.1969	0.201	4.90	5.00	5.10	1
E	0.248	0.2519	0.256	6.30	6.40	6.50	
E1	0.169	0.1732	0.177	4.30	4.40	4.50	1
e	--	0.026 BSC	--	--	0.65 BSC	--	
L	0.020	0.024	0.028	0.50	0.60	0.70	
∞	0°	4°	8°	0°	4°	8°	

JEDEC #: MO-153

Controlling Dimension is Millimeters

- Notes:
1. "D" and "E1" are reference datums and do not include mold flash or protrusions, but do include mold mismatch and are measured at the parting line, mold flash or protrusions shall not exceed 0.20 mm per side.
 2. Dimension "b" does not include dambar protrusion/intrusion. Allowable dambar protrusion shall be 0.13 mm total in excess of "b" dimension at maximum material condition. Dambar intrusion shall not reduce dimension "b" by more than 0.07 mm at least material condition.
 3. These dimensions apply to the flat section of the lead between 0.10 and 0.25 mm from lead tips.

9. PACKAGE THERMAL RESISTANCE

Package	Symbol	Min	Typ	Max	Units
SOIC TSSOP	(for multi-layer boards) θ_{JA}	-	74	-	°C/Watt
	(for multi-layer boards) θ_{JA}	-	89	-	°C/Watt

10. REFERENCES

CDB4341 Evaluation Board Datasheet

11. REVISION HISTORY

Revision	Changes
F4	Added lead-free packaging information
F5	Corrected Dimension e in TSSOP Package Drawing value for NOM Millimeters from 0.065 to 0.65

Contacting Cirrus Logic Support

For all product questions and inquiries, contact a Cirrus Logic Sales Representative.

To find the one nearest to you, go to www.cirrus.com/corporate/contacts/sales.cfm

IMPORTANT NOTICE

Cirrus Logic, Inc. and its subsidiaries ("Cirrus") believe that the information contained in this document is accurate and reliable. However, the information is subject to change without notice and is provided "AS IS" without warranty of any kind (express or implied). Customers are advised to obtain the latest version of relevant information to verify, before placing orders, that information being relied on is current and complete. All products are sold subject to the terms and conditions of sale supplied at the time of order acknowledgment, including those pertaining to warranty, indemnification, and limitation of liability. No responsibility is assumed by Cirrus for the use of this information, including use of this information as the basis for manufacture or sale of any items, or for infringement of patents or other rights of third parties. This document is the property of Cirrus and by furnishing this information, Cirrus grants no license, express or implied under any patents, mask work rights, copyrights, trademarks, trade secrets or other intellectual property rights. Cirrus owns the copyrights associated with the information contained herein and gives consent for copies to be made of the information only for use within your organization with respect to Cirrus integrated circuits or other products of Cirrus. This consent does not extend to other copying such as copying for general distribution, advertising or promotional purposes, or for creating any work for resale.

CERTAIN APPLICATIONS USING SEMICONDUCTOR PRODUCTS MAY INVOLVE POTENTIAL RISKS OF DEATH, PERSONAL INJURY, OR SEVERE PROPERTY OR ENVIRONMENTAL DAMAGE ("CRITICAL APPLICATIONS"). CIRRUS PRODUCTS ARE NOT DESIGNED, AUTHORIZED OR WARRANTED FOR USE IN AIRCRAFT SYSTEMS, MILITARY APPLICATIONS, PRODUCTS SURGICALLY IMPLANTED INTO THE BODY, AUTOMOTIVE SAFETY OR SECURITY DEVICES, LIFE SUPPORT PRODUCTS OR OTHER CRITICAL APPLICATIONS. INCLUSION OF CIRRUS PRODUCTS IN SUCH APPLICATIONS IS UNDERSTOOD TO BE FULLY AT THE CUSTOMER'S RISK AND CIRRUS DISCLAIMS AND MAKES NO WARRANTY, EXPRESS, STATUTORY OR IMPLIED, INCLUDING THE IMPLIED WARRANTIES OF MERCHANTABILITY AND FITNESS FOR PARTICULAR PURPOSE, WITH REGARD TO ANY CIRRUS PRODUCT THAT IS USED IN SUCH A MANNER. IF THE CUSTOMER OR CUSTOMER'S CUSTOMER USES OR PERMITS THE USE OF CIRRUS PRODUCTS IN CRITICAL APPLICATIONS, CUSTOMER AGREES, BY SUCH USE, TO FULLY INDEMNIFY CIRRUS, ITS OFFICERS, DIRECTORS, EMPLOYEES, DISTRIBUTORS AND OTHER AGENTS FROM ANY AND ALL LIABILITY, INCLUDING ATTORNEYS' FEES AND COSTS, THAT MAY RESULT FROM OR ARISE IN CONNECTION WITH THESE USES.

Cirrus Logic, Cirrus, and the Cirrus Logic logo designs are trademarks of Cirrus Logic, Inc. All other brand and product names in this document may be trademarks or service marks of their respective owners.

°C is a registered trademark of Philips Semiconductor.

SPI is a trademark of Motorola, Inc.

Looking for pricing, stock, or lifecycle information?

Click below to explore more details on WIN SOURCE:

 [View CS4341-CZZR on WIN SOURCE](#)

 [Cirrus Logic Inc. Information](#)

Optimize Your Supply Chain with WIN SOURCE Solutions

-  Global Sourcing Solution
-  Obsolete Management
-  Cost Control Management
-  Shortage Management
-  Alternative Solution
-  Excess Inventory Management