



**THE DATASHEET OF
AGQ100-48S1V5-4**



AGQ100&AVQ100B Series DC/DC Converter Technical Reference Notes

Industry Standard Quarter Brick: 36~75V Input, 1.2V~5V Single Output

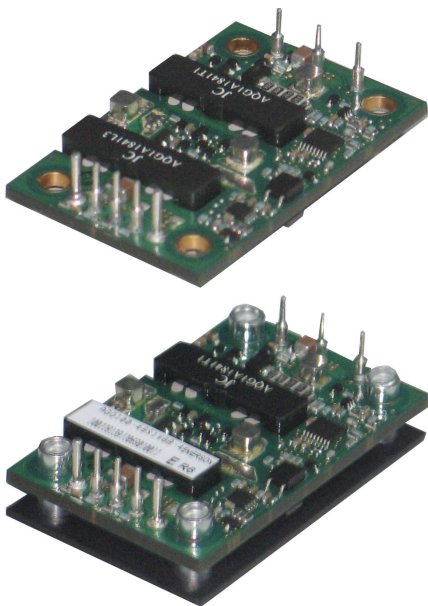

Industry Standard Quarter Brick :
2.28"X 1.45" X 0.38" (open frame) or
2.28" x 1.45" x 0. 5" (baseplate)

Options

- Choice of positive logic or negative logic for CNT function
- Choice of short pins or long pins

Description

The AGQ100&AVQ100B series is a new open frame/baseplate DC-DC converter for optimum efficiency and power density. The AGQ100&AVQ100B provide up to 25~30A output current in an industry standard quarter brick, which makes it an ideal choice for small space, high current and low voltage applications. The AGQ100&AVQ100B series uses an industry standard quarter brick (open frame/baseplate): 57.9mm % 36.8mm % 9.7/12.7mm (2.28" % 1.45" % 0.38/0.5") and standard

Features

- Delivers up to 20~30A output current
- Industry standard quarter brick (open frame/baseplate): 57.9mm % 36.8mm % 9.7/12.7mm (2.28" % 1.45" % 0.38/0.5")
- Basic isolation
- Ultra high efficiency
- High power density
- Low output noise
- Industry standard pinout
- 2:1 wide input voltage of 36-75V
- CNT function
- Remote sense
- Trim function: +10%/-20%
- Input under-voltage lockout
- Output over-current protection (hiccup)
- Output over-voltage protection (hiccup)
- Over-temperature protection
- RoHS compliant

pinouts configuration. It includes extensive control and protection features for maximum flexibility and provides a versatile solution for a whole range of applications with its input voltage range of 36-75 VDC and it can provide 1.2V~5V single output that are isolated from inputs. The converter can achieve ultra high efficiencies and excellent thermal performance, for most applications a heat sink is not required. The product features fast dynamic response characteristics and low output ripple. This high quality and highly reliable product is competitively priced and an ideal solution for distributed power, telecoms and datacom applications.

Module Numbering

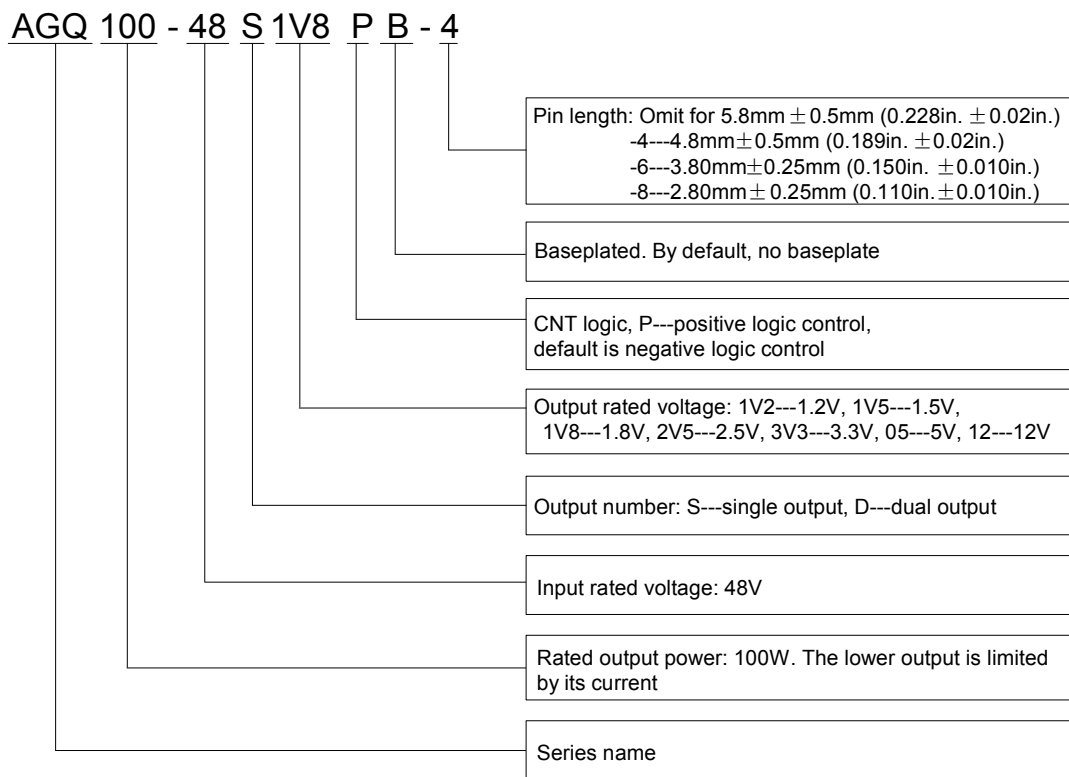

Note:

The following is based on negative logic modules. Positive logic modules are the same with negative ones except for their pin logic.

Electrical Specifications

Unless otherwise indicated, specifications apply over all operating input voltage and temperature conditions. Standard test condition on a single unit is as following:

- Tc (board): 25 °C
- Airflow: 200 LFM
- +Vin: 48V ± 2%
- Vin: Return pin for +Vin
- CNT: Connect to -Vin for negative logic
Open for positive logic
- +Vout: Connect to load
- Vout: Connect to load (return)
- +Sense: Connect to +Vout
- Sense: Connect to -Vout
- Trim (Vadj): Open

Input Specifications

Parameter	Symbol	Min	Typ	Max	Unit
Operating Input Voltage	VI	36	48	75	VDC
Maximum Input Current (VI = 0 to VI,max, Io = Io,max)	II,max	-	-	3.2	A
Input Reflected-ripple Current (5Hz to 20MHz, 12uH source impedance, TA = 25 °C)	II	-	-	20	mAp-p
Supply voltage rejection (1kHz)	-	50	60	-	dB

CAUTION: This power module is not internally fused. An input line fuse must always be used.

Absolute Maximum Ratings

Stresses in excess of the absolute maximum ratings can cause permanent damage to the device. These are absolute stress ratings only. Functional operation of the device is not implied at these or any other conditions in excess of those given in the operational sections of the IPS. Exposure to absolute maximum ratings for extended periods can adversely affect device reliability.

Parameter		Device	Symbol	Min	Typ	Max	Unit
Input Voltage	Continuous	All	VI	-	-	80	Vdc
	Transient (100ms)	All	VI, trans	-	-	100	Vdc
Operating Ambient Temperature (See Thermal Consideration)		All	Ta	-40	-	85	°C
Operating Board Temperature		All	Tc	-40	-	110	°C
Storage Temperature		All	TSTG	-55	-	125	°C
Operating Humidity		All	-	-	-	95	RH%
Basic Input-Output Isolation (Conditions: 1mA for 60 sec, slew rate of 1500V/10sec)		All	-			2000	Vdc
Output Power	1.2V		Po,max	-	-	36	W
	1.5V	37.5					
	1.8V	45					
	3.3V	82.5					
	5V	100					

Output Specifications

All specifications are typical at normal input $V_{in}=48V_{dc}$, rated output current at 25°C ambient unless otherwise specified.

Parameter		Device	Symbol	Min	Typ	Max	Unit
Output Ripple and Noise Peak-to-Peak (5 Hz to 20 MHz) (Across 1 μ F @50V, X7R ceramic capacitor & 470 μ F @25V LOW ESR Aluminum capacitor)		1.2V	-	-	35	-	mVp-p
		1.5V			35		
		1.8V			40		
		3.3V			50		
		5V			40		
External Load Capacitance		1.2V	-	-	-	10,000	μ F
		1.5V				10,000	
		1.8V				10,000	
		3.3V				10,000	
		5V				5000	
Output Voltage Setpoint ($V_I = V_{I,min}$ to $V_{I,max}$; $I_o = I_{o,max}$; $T_a = 25^\circ C$)		1.2V	$V_{o,set}$	1.18	1.2	1.22	Vdc
		1.5V		1.48	1.5	1.52	
		1.8V		1.77	1.8	1.83	
		3.3V		3.25	3.3	3.35	
		5V		4.95	5	5.05	
Output Regulation	Line ($V_{i,min}$ to $V_{i,max}$)	1.2V	-	-	1	-	mV
		1.5V			1		
		1.8V			1		
		3.3V			1		
		5V			1		
	Load ($I_{o,min}$ to $I_{o,max}$)	1.2V	-	-	1	-	mV
		1.5V			1		
		1.8V			1		
		3.3V			1		
		5V			1		
Temperature ($T_c = -40^\circ C$ to $+100^\circ C$)		All	-	-	-	0.02	% V_o / $^\circ C$

Parameter	Device	Symbol	Min	Typ	Max	Unit
Rated Output Current	1.2V,	Io	0	-	30	A
	1.5V				25	
	1.8V				25	
	3.3V				25	
	5V				20	
Output Current-limit Inception (Hiccup)	1.2V	Io	33	-	42	A
	1.5V		27.5		35	
	1.8V		28		35	
	3.3V		28		35	
	5V		22		28	
Efficiency (VI = VI,nom; 100%Io,max ; TA = 25°C)	1.2V	-	-	87	-	%
	1.5V			87.5		
	1.8V			89		
	3.3V			91		
	5V			93		
Efficiency (VI = VI,nom ; 50%Io,max ; TA = 25°C)	1.2V	-	-	86.5	-	%
	1.5V			88.5		
	1.8V			88.5		
	3.3V			92		
	5V			92		

Output Specifications (Cont)

Parameter		Device	Symbol	Min	Typ	Max	Unit
Dynamic Response ($\Delta I_o/\Delta t = 1A/10\mu s$, $V_I = V_{I,nom}$; $T_a = 25^\circ C$)	25% $I_{o,nom}$ step from 50% $I_{o,nom}$	1.2V	-		50		mV
		1.5V			50		
		1.8V			45		
		3.3V			60		
		5V			60		
	Deviation Settling Time	1.2V	-		100	-	μsec
		1.5V			140		
		1.8V			70		
		3.3V			70		
		5V			70		
Dynamic Response ($\Delta I_o/\Delta t = 1A/1\mu s$; $V_I = V_{I,nom}$; $T_a = 25^\circ C$, additional 220 μF load capacitor)	25% $I_{o,nom}$ step from 50% $I_{o,nom}$	1.2V	-		150	-	mv
		1.5V			150		
		1.8V			140		
		3.3V			150		
		5V			160		
	Deviation Settling Time	1.2V	-		60	-	μsec
		1.5V			100		
		1.8V			60		
		3.3V			80		
		5V			80		
Turn-On Time ($I_o = I_{o,max}$; V_o within 1%)		All	-	-	3	-	msec
Output Voltage Overshoot ($I_o = I_{o,max}$; $T_a = 25^\circ C$)		All	-	-	0	-	% V_o
Switching Frequency		All	-		310		kHz

Feature Specifications

Parameter		Device	Symbol	Min	Typ	Max	Unit
Enable pin voltage	Logic Low	All		-0.7	-	1.2	V
	Logic High	All		3.5	-	12	V
Enable pin current (leakage current, @10V)	Logic Low	All		-	0.4	-	mA
	Logic High	All		-	-	-	μA
Output Voltage Adjustment Range		All*	-	80	-	110	%Vo
Output Over-voltage (Hiccup)		1.2V	Voclamp	1.4	-	2.0	V
		1.5V		1.8		2.5	
		1.8V		2.2		3.0	
		3.3V		3.9		5.0	
		5V		6.0		7.5	
Over-temperature Protection (Auto-recovery)		All			125		C
Under-voltage Lockout	Turn-on Point	All	-	31	34	36	V
	Turn-off Point	All	-	30	33	35	V
Isolation Capacitance		All	-	-	3000	-	PF
Isolation Resistance		All	-	10	-	-	MΩ
Calculated MTBF (Io = Io,max ; Tc = 25°C)		All	-	-	2,500,000	-	Hours
Weight		All	-	-	-	30	g (oz.)

* Output Voltage Adjustment Rang of 12V module is 90% to 110%.

Characteristic Curves

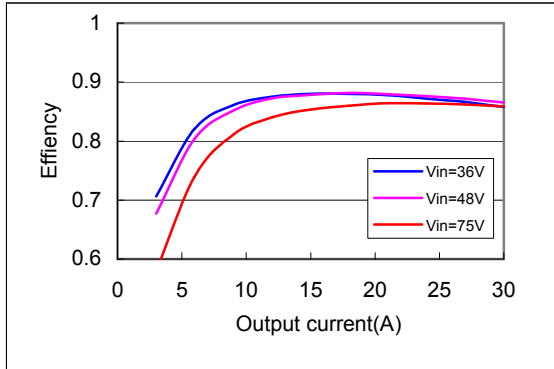

Fig. 1 Typical efficiency of AGQ100-48S1V2

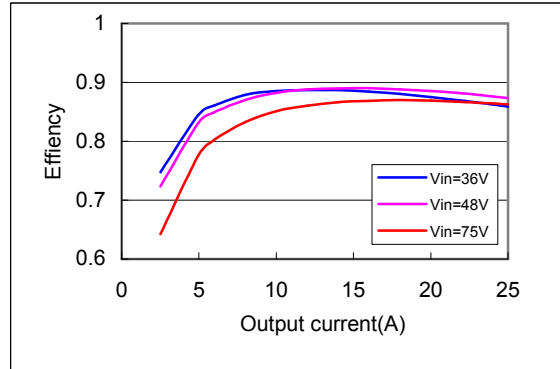

Fig. 2 Typical efficiency of AGQ100-48S1V5

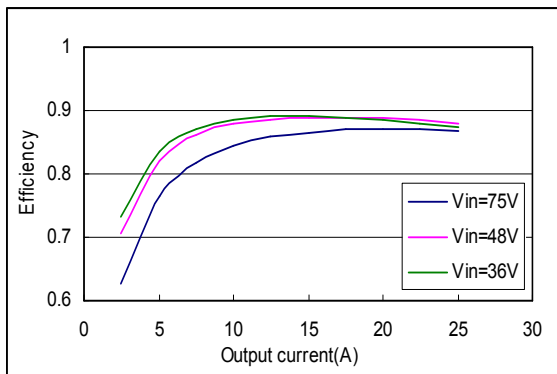

Fig. 3 Typical efficiency of AGQ100-48S1V8

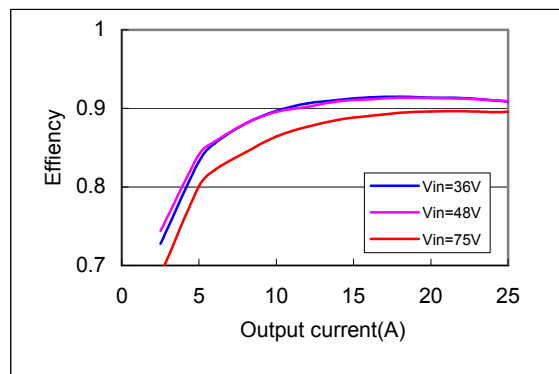

Fig. 4 Typical efficiency of AVQ100B-48S3V3

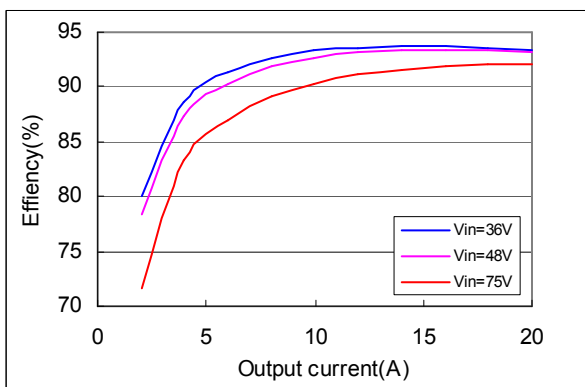

Fig. 5 Typical efficiency of AVQ100B-48S05

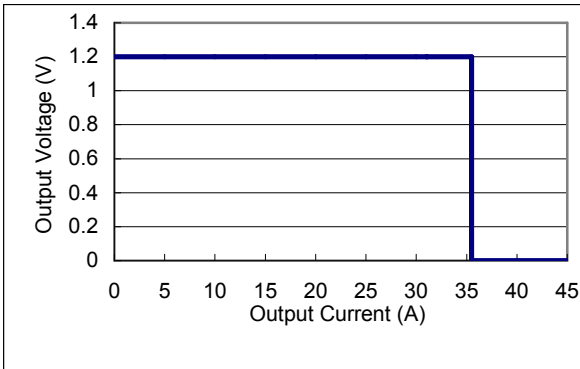

Fig. 6 Typical over-current of AGQ100-48S1V2

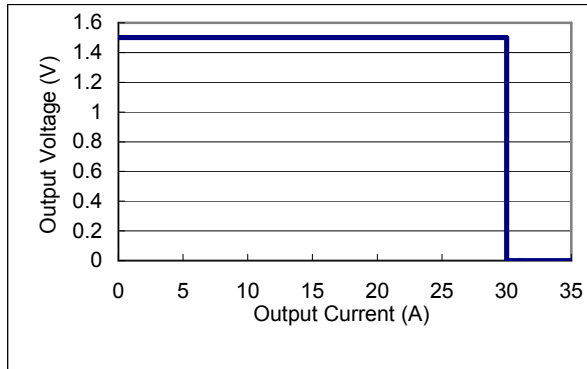

Fig. 7 Typical over-current of AGQ100-48S1V5

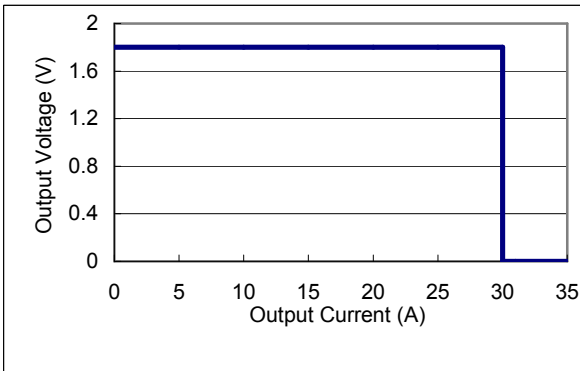

Fig. 8 Typical over-current of AGQ100-48S1V8

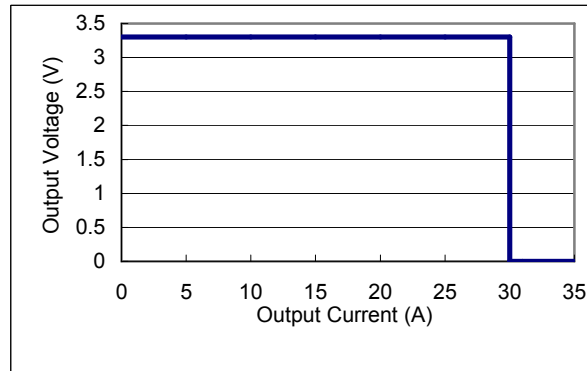

Fig. 9 Typical over-current of AVQ100B-48S3V3

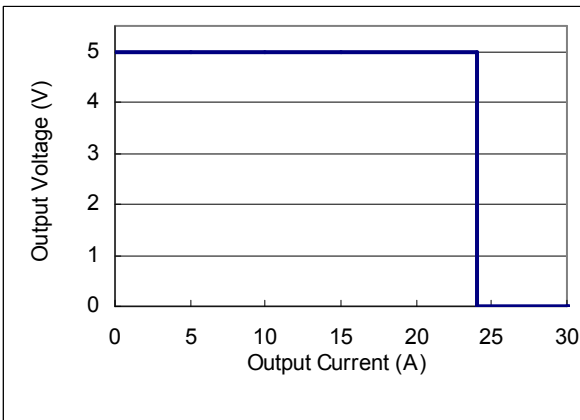

Fig. 10 Typical over-current of AVQ100B-48S05

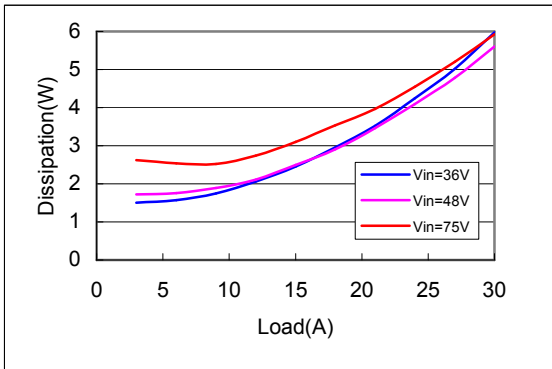

Fig. 11 Typical power dissipation curve of AGQ100-48S1V2

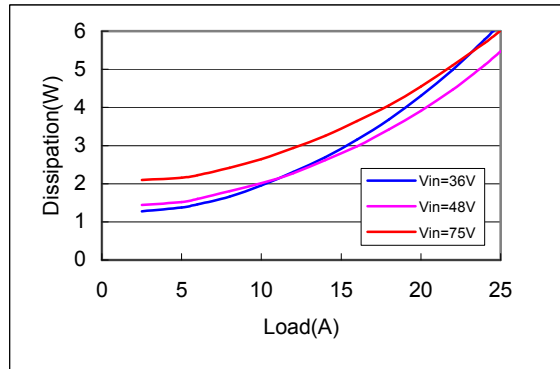

Fig. 12 Typical power dissipation curve of AGQ100-48S1V5

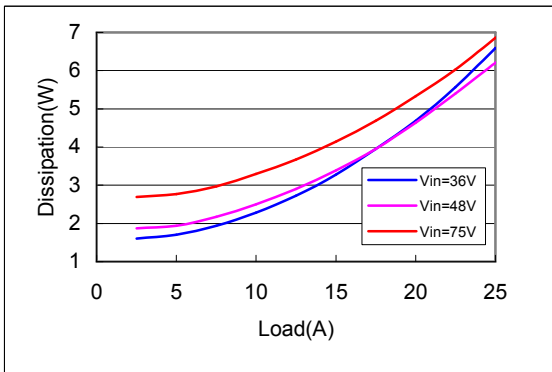

Fig. 13 Typical power dissipation curve of AGQ100-48S1V8

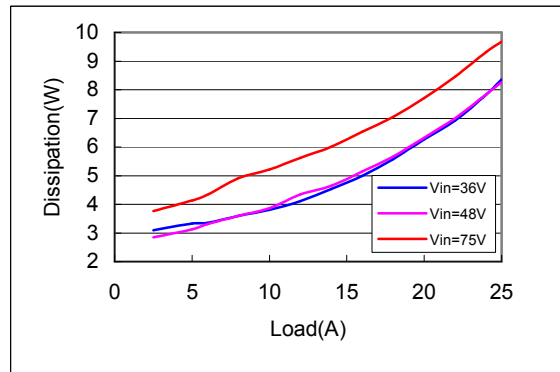

Fig. 14 Typical power dissipation curve of AVQ100B-48S3V3

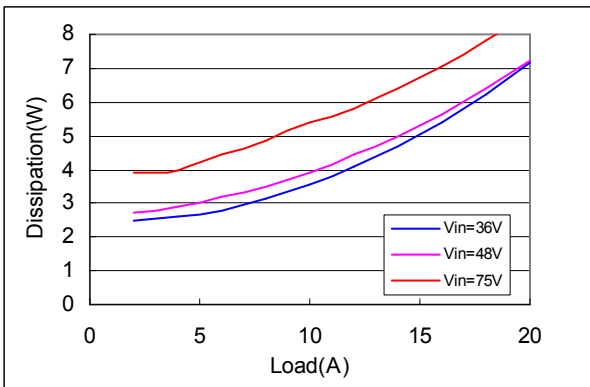

Fig. 15 Typical power dissipation curve of AVQ100B-48S05

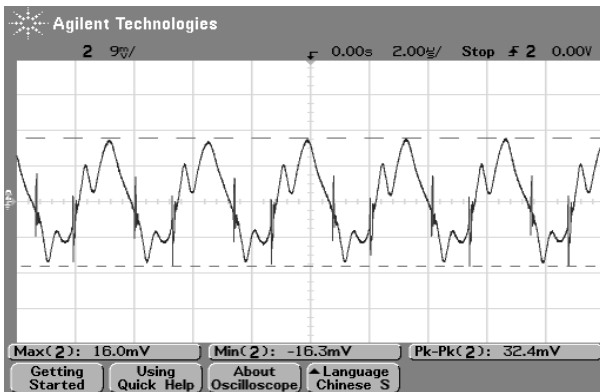

Fig. 16 Typical output ripple voltage AGQ100 -48S1V2, room temperature, $I_o = I_{o,max}$

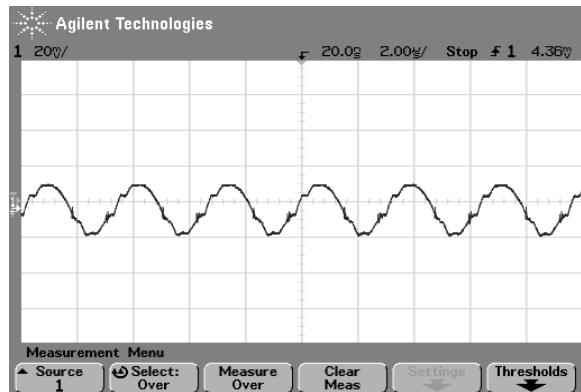

Fig. 17 Typical output ripple voltage AGQ100 -48S1V5, room temperature, $I_o = I_{o,max}$

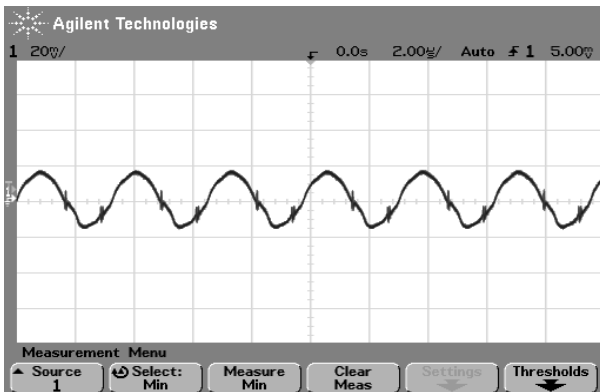

Fig. 18 Typical output ripple voltage AGQ100 -48S1V8, room temperature, $I_o = I_{o,max}$

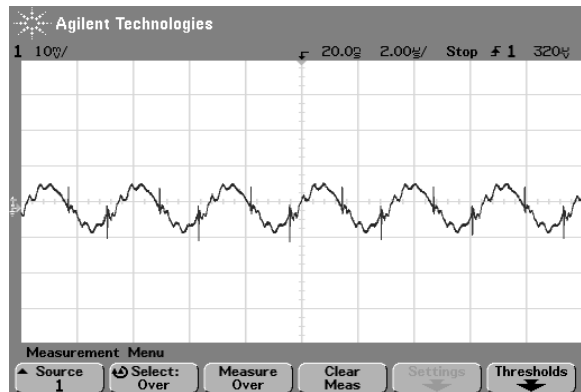

Fig. 19 Typical output ripple voltage AVQ100B -48S3V3, room temperature, $I_o = I_{o,max}$

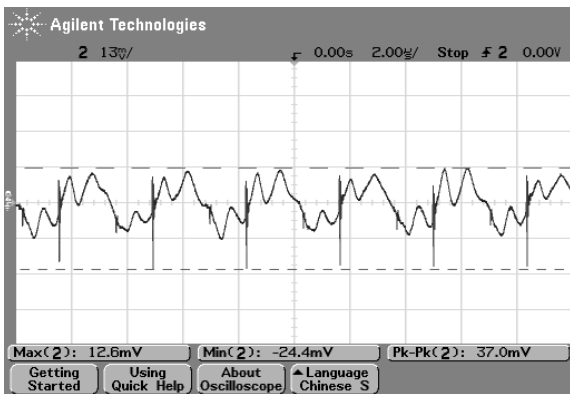

Fig. 20 Typical output ripple voltage AVQ100B -48S05, room temperature, $I_o = I_{o,max}$



Fig.21 Typical start-up from power on of AGQ100-48S1V2



Fig.22 Typical start-up from CNT on of AGQ100-48S1V2

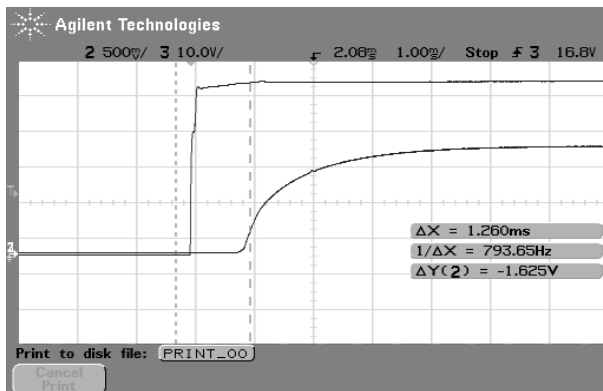

Fig.23 Typical start-up from power on of AGQ100-48S1V5

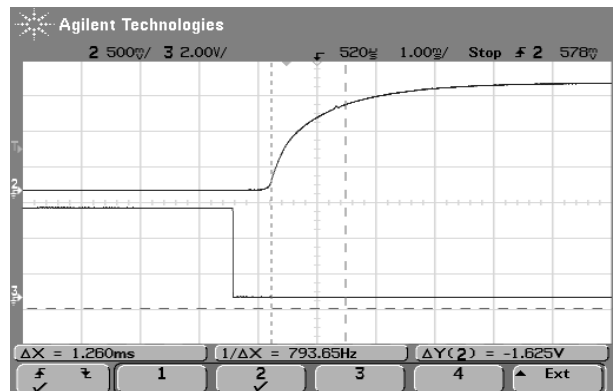

Fig.24 Typical start-up from CNT on of AGQ100-48S1V5

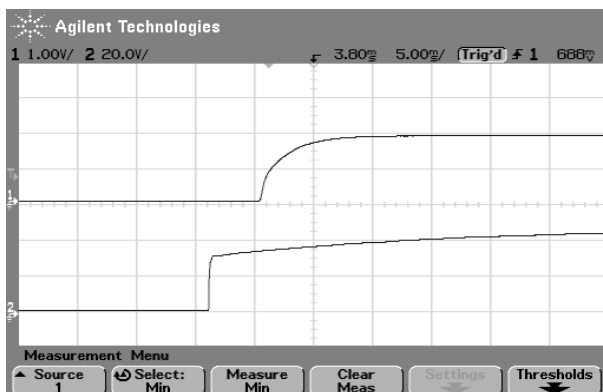

Fig.25 Typical start-up from power on of AGQ100-48S1V8

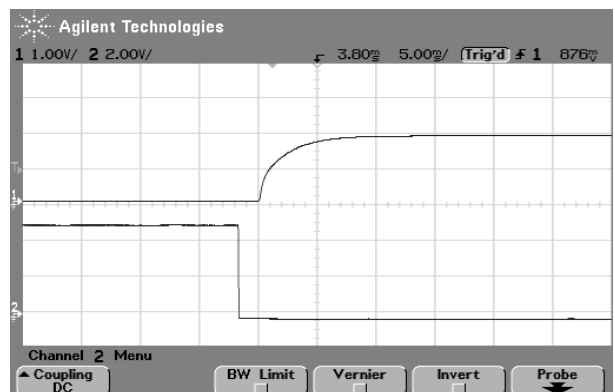

Fig.26 Typical start-up from CNT on of AGQ100-48S1V8

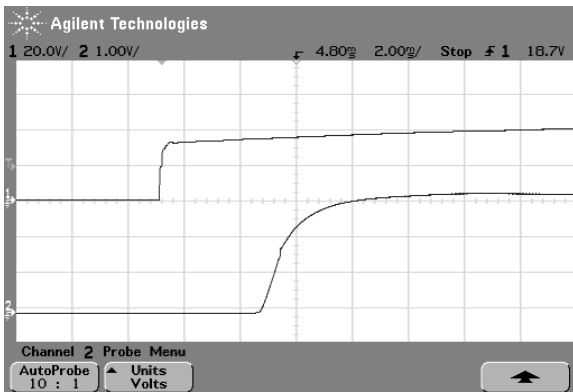

Fig.27 Typical start-up from power on of AVQ100B-48S3V3

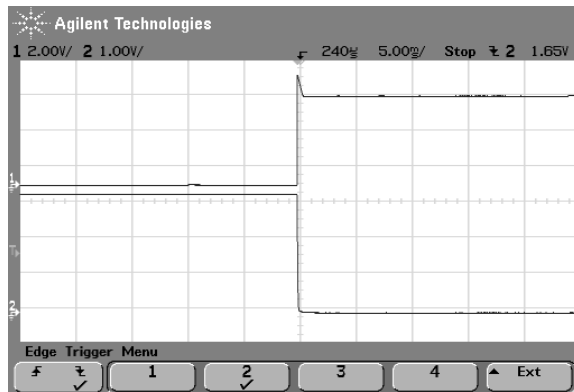

Fig.28 Typical start-up from CNT on of AVQ100B-48S3V3

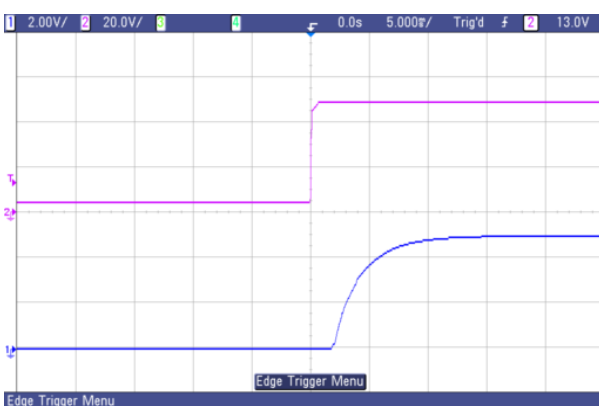

Fig.29 Typical start-up from power on of AVQ100B-48S05



Fig.30 Typical start-up from CNT on of AVQ100B-48S05

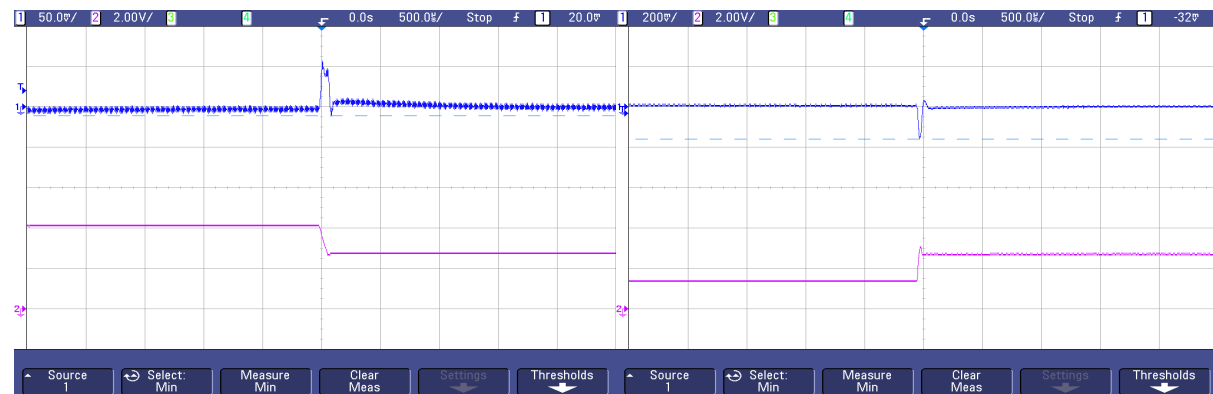

Fig.31 Typical transient response to step decrease in load from 50% to 25%, room temperature, 48Vdc input ($\Delta I_o/\Delta t = 0.1A/1\mu s$) of AGQ100-48S1V2

Fig.32 Typical transient response to step decrease in load from 50% to 25%, room temperature, 48Vdc input ($\Delta I_o/\Delta t = 1A/1\mu s$) of AGQ100-48S1V2

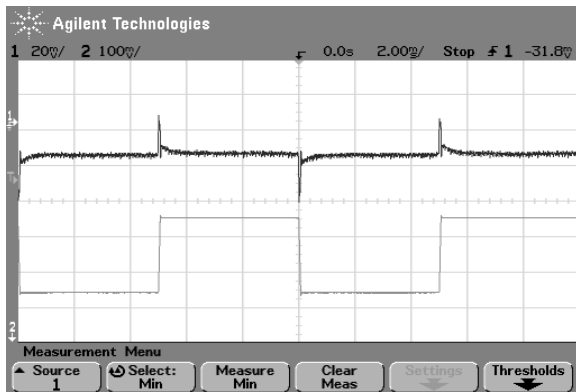

Fig.33 Typical transient response to step decrease in load from 50% to 25%, room temperature, 48Vdc input ($\Delta I_o/\Delta t = 0.1A/1\mu s$) of AGQ100-48S1V5

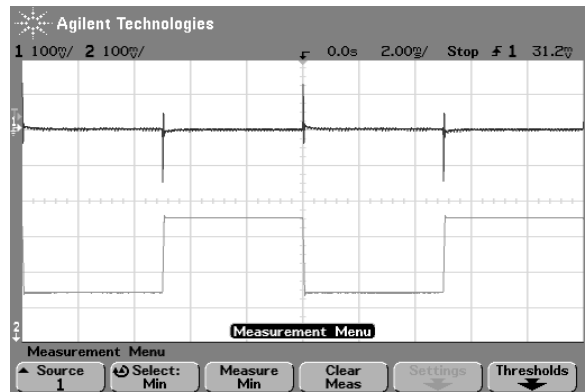

Fig.34 Typical transient response to step decrease in load from 50% to 25%, room temperature, 48Vdc input ($\Delta I_o/\Delta t = 1A/1\mu s$) of AGQ100-48S1V5

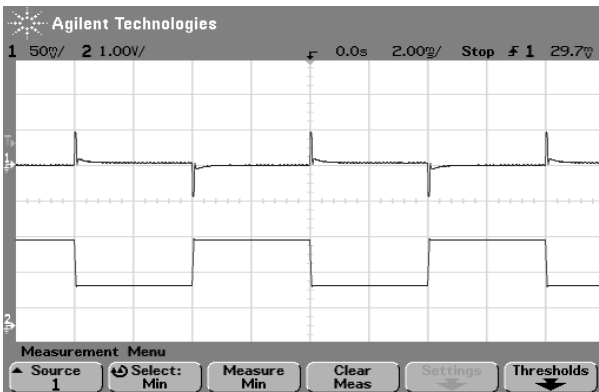

Fig.35 Typical transient response to step decrease in load from 50% to 25%, room temperature, 48Vdc input ($\Delta I_o/\Delta t = 0.1A/1\mu s$) of AGQ100-48S1V8

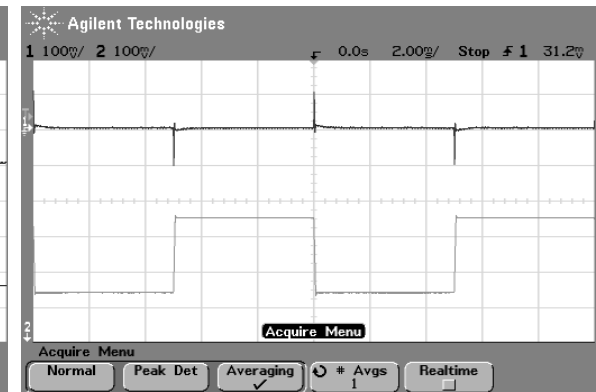

Fig.36 Typical transient response to step decrease in load from 50% to 25%, room temperature, 48Vdc input ($\Delta I_o/\Delta t = 1A/1\mu s$) of AGQ100-48S1V8

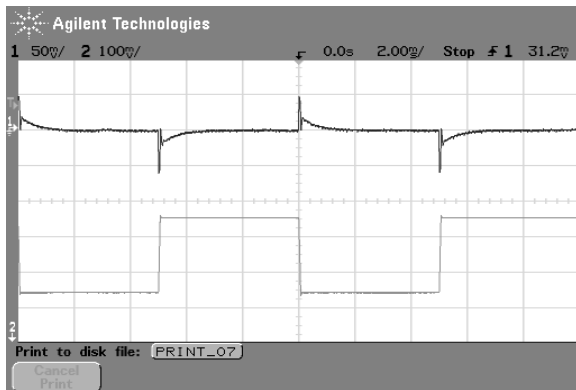

Fig.37 Typical transient response to step decrease in load from 50% to 25%, room temperature, 48Vdc input ($\Delta I_o/\Delta t = 0.1A/1\mu s$) of AVQ100B-48S3V3

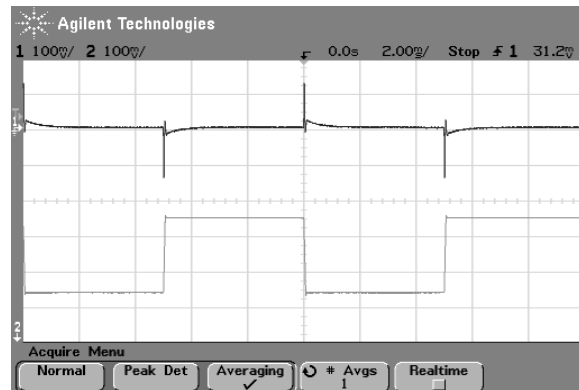

Fig.38 Typical transient response to step decrease in load from 50% to 25%, room temperature, 48Vdc input ($\Delta I_o/\Delta t = 1A/1\mu s$) of AVQ100B-48S3V3

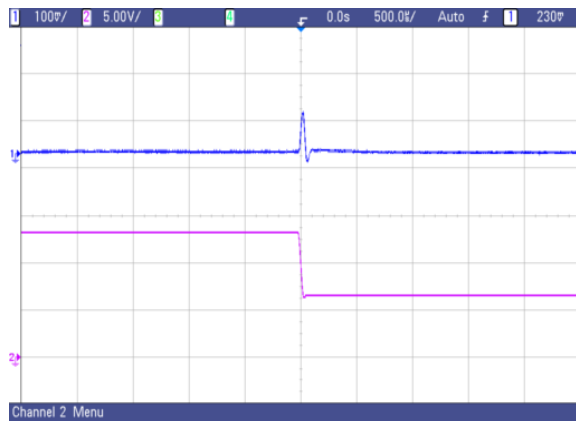

Fig.39 Typical transient response to step decrease in load from 50% to 25%, room temperature, 48Vdc input ($\Delta I_o/\Delta t = 0.1A/1\mu s$) of AVQ100B-48S05



Fig.40 Typical transient response to step decrease in load from 50% to 25%, room temperature, 48Vdc input ($\Delta I_o/\Delta t = 1A/1\mu s$) of AVQ100B-48S05

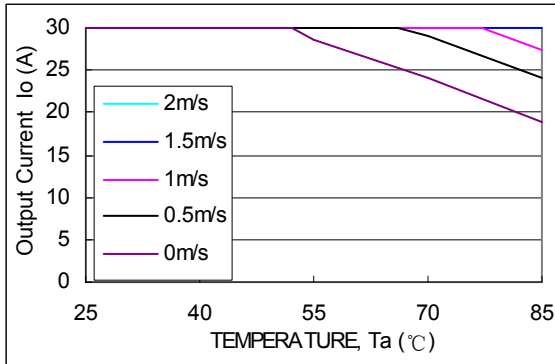

Fig.41 Output power derating AGQ100-48S1V2 (airflow direction from output to input, open frame)

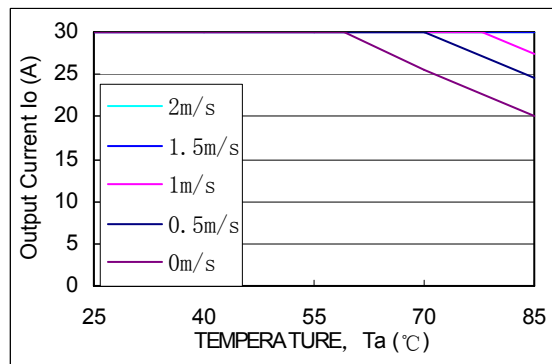

Fig.42 Output power derating AGQ100-48S1V2 (airflow direction from output to input, baseplate)

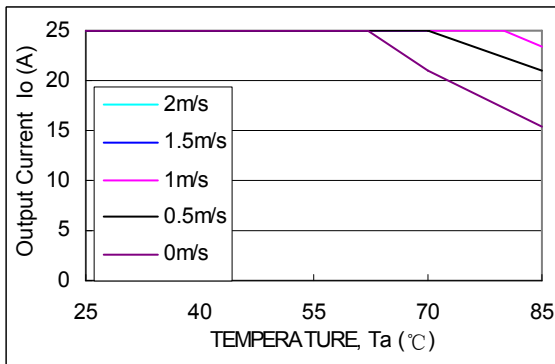

Fig.43 Output power derating AGQ100-48S1V5 (airflow direction from output to input, open frame)

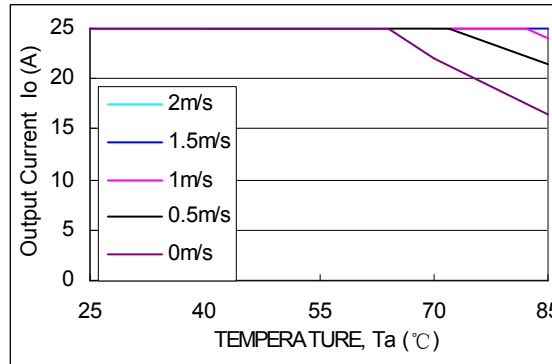

Fig.44 Output power derating AGQ100-48S1V5 (airflow direction from output to input, baseplate)

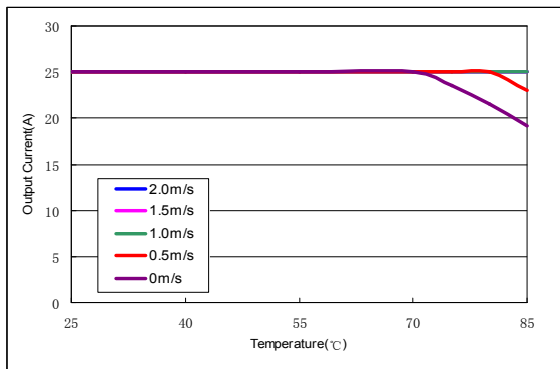

Fig.45 Output power derating AGQ100-48S1V8 (airflow direction from output to input, open frame)

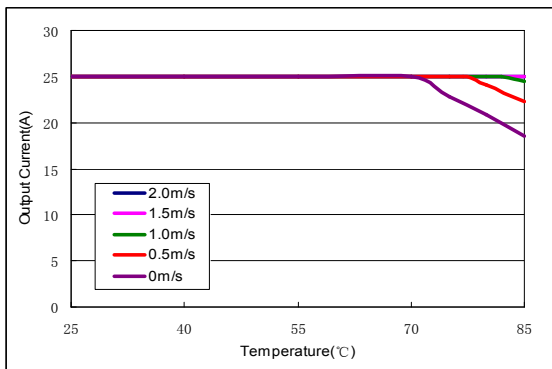

Fig.46 Output power derating AGQ100-48S1V8 (airflow direction from output to input, baseplate)

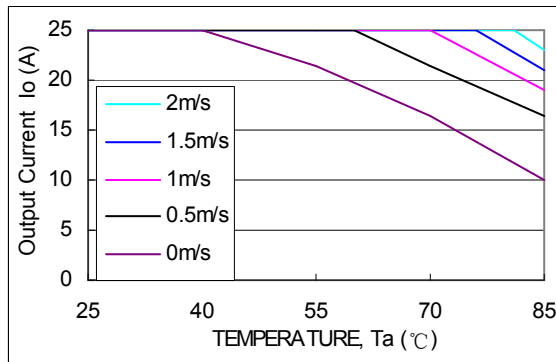
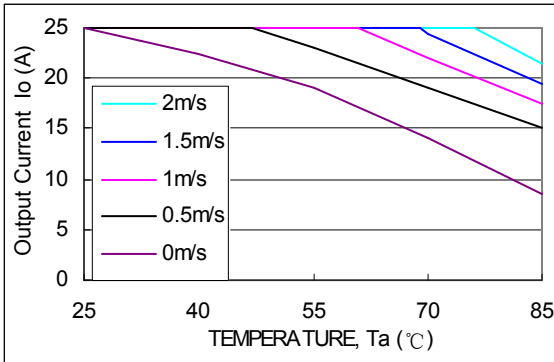

Fig.47 Output power derating AVQ100B-48S3V3 (airflow direction from output to input, open frame)

Fig.48 Output power derating AVQ100B-48S3V3 (airflow direction from output to input, baseplate)

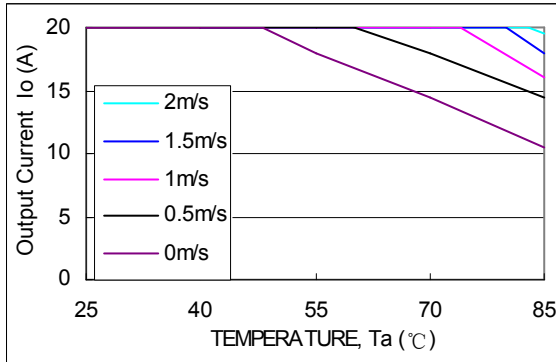
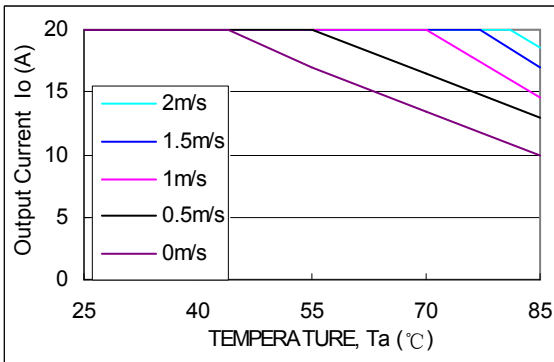

Fig.49 Output power derating AVQ100B-48S05 (airflow direction from output to input, open frame)

Fig.50 Output power derating AVQ100B-48S05 (airflow direction from output to input, baseplate)

Feature Description

CNT Function

The converter is equipped with a primary ON/OFF pin used to remotely turn converter on or off via a system signal. Two CNT logic options are available. For the positive logic model a system logic low signal will turn the unit off. For the negative logic model a system logic high signal will turn the converter off. For negative logic models where no control signal will be used the ON/OFF pin should be connected directly to $-V_{in}$ to ensure proper operation. For positive logic models where no control signal will be used the ON/OFF pin should be left unconnected.

The following figure shows a few simple CNT circuits.

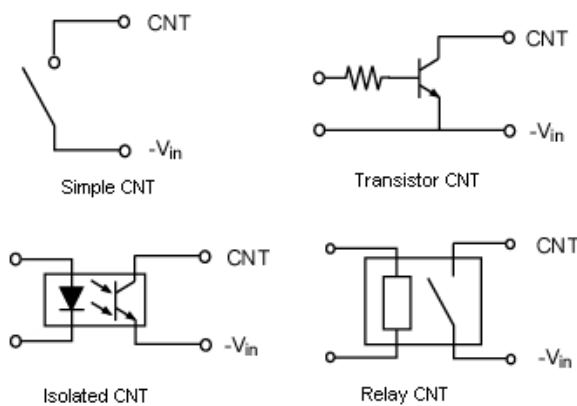

Fig. 51 CNT Circuit

Remote Sense

The converter can remotely sense both lines of its output which moves the effective output voltage regulation point from the output terminals of the unit to the point of connection of the remote sense pins. The sense leads

conduct very little current compared with the power leads and therefore provide a more accurate indication of load voltage for regulation purposes. This feature automatically adjusts the real output voltage of the converter in order to compensate for voltage drops in distribution and maintain a regulated voltage at the point of load.

When the converter is supporting loads far away, or is used with undersized cabling, significant voltage drop can occur at the load. The best defense against such drops is to locate the load close to the converter and to ensure adequately sized cable is used. When this is not possible, the converter can compensate for a drop of up to 10% V_o , through use of the sense leads.

When used, the + Sense and - Sense leads should be connected from the converter to the point of load as shown in Figure 52, using twisted pair wire, or parallel pattern to reduce noise effect. The converter will then regulate its output voltage at the point where the leads are connected. Care should be taken not to reverse the sense leads. If reversed, the converter will trigger OVP protection.

When not used, the +Sense lead must be connected with $+V_o$, and -Sense with $-V_o$. If +Sense and -Sense are not connected the output voltage could drift beyond the nominal range. Although the output voltage can be increased by both the remote sense and by the trim, the maximum increase for the output voltage is not the sum of both. The maximum increase is the larger of either the remote sense or the trim.

Note that at elevated output voltages the maximum power rating of the module remains the same, and the output current capability will decrease correspondingly.

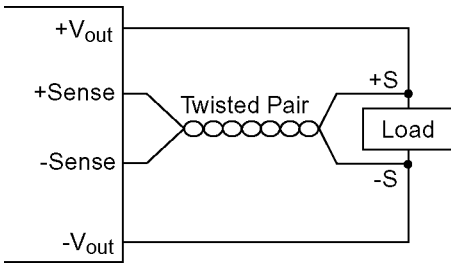

Fig. 52 Sense connections

Trim

The +Vo output voltage of the AGQ100&AVQ100B can be trimmed using the trim pin provided. Applying a resistor to the trim pin through a voltage divider from the output will cause the +Vo output to increase by up to 10% or decrease by up to 20%. Trimming up by more than 10% of the nominal output may activate the OVP circuit or damage the converter. Trimming down more than 20% can cause the converter to regulate improperly. If the trim pin is not needed, it should be left open.

Trim up

With an external resistor connected between the TRIM and +SENSE pins, the output voltage set point increases (see Figure 53).

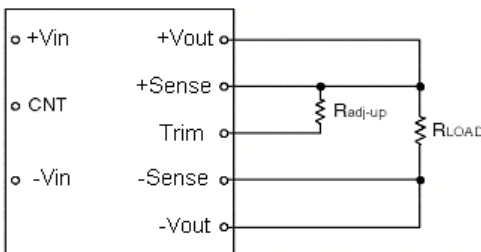

Fig. 53 Trim up circuit

The following equation determines the required external-resistor value to obtain a percentage output voltage change of %.

For 1.2V:

$$R_{adj-up} = \frac{5.1 \times V_{nom} \times (100 + \Delta)}{0.6 \times \Delta} - \frac{510}{\Delta} - 10.2(K\Omega)$$

For others:

$$R_{adj-up} = \frac{5.1 \times V_{nom} \times (100 + \Delta)}{1.225 \times \Delta} - \frac{510}{\Delta} - 10.2(K\Omega)$$

Note: $\Delta = (V_o - V_{nom}) \% 100 / V_{nom}$

For example: 1.8V to trim up the output to 1.98V,

$$\Delta = (1.98 - 1.8) \% 100 / 1.8 = 10$$

$$R_{adj-up} = \frac{5.1 \times 1.8 \times (100 + 10)}{1.225 \times 10} - \frac{510}{10} - 10.2(K\Omega)$$

$$R_{adj-up} = 21.23(K\Omega)$$

Trim down

With an external resistor between the TRIM and -SENSE pins, the output voltage set point decreases (see Figure 54).

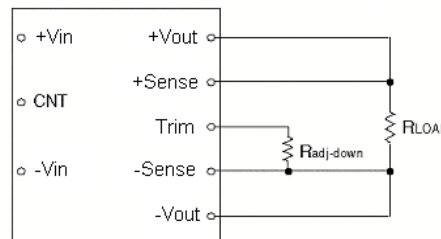

Fig. 54 Trim down circuit

The following equation determines the required external-resistor value to obtain a percentage output voltage change of %.

$$R_{adj-down} = \frac{510}{\Delta} - 10.2(K\Omega)$$

Note: $\Delta = (V_{nom} - V_o) \% 100 / V_{nom}$

For example: 1.8V to trim down the output to 1.62V,

$$\Delta = (1.8 - 1.62) \% 100 / 1.8 = 10$$

$$R_{adj-down} = \frac{510}{10} - 10.2(K\Omega)$$

$$R_{adj-down} = 40.8(K\Omega)$$

Although the output voltage can be increased by both the remote sense and by the trim, the maximum increase for the output voltage is not the sum of both. The maximum increase is the larger of either the remote sense or the trim.

Note that at elevated output voltages the maximum power rating of the module remains the same, and the output current capability will decrease correspondingly.

Minimum Load Requirements

There is no minimum load requirement for the AGQ100&AVQ100B series module.

Output Capacitance

High output current transient rate of change (high di/dt) loads may require high values of output capacitance to supply the instantaneous energy requirement to the load. To minimize the output voltage transient drop during this transient, low ESR (Equivalent Series Resistance) capacitors may be required, since a high ESR will produce a correspondingly higher voltage drop during the current transient.

When the load is sensitive to ripple and noise, an output filter can be added to minimize the effects. A simple output filter to reduce output ripple and noise can be made by connecting a capacitor C1 across the output as shown in Figure 55. The recommended value for the output capacitor C1 is 470 μ F.

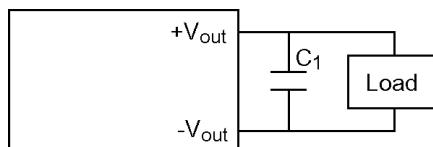

Fig. 55 Output ripple filter

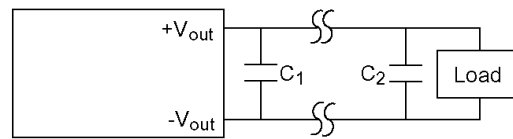

Fig. 56 Output ripple filter for a distant load

Extra care should be taken when long leads or traces are used to provide power to the load. Long lead lengths increase the chance for noise to appear on the lines. Under these conditions C1 can be added across the load, with a 1 μ F ceramic capacitor C2 in parallel generally as shown in Figure 56.

Decoupling

Noise on the power distribution system is not always created by the converter. High speed analog or digital loads with dynamic power demands can cause noise to cross the power inductor back onto the input lines. Noise can be reduced by decoupling the load. In most cases, connecting a 10 μ F tantalum or ceramic capacitor in parallel with a 0.1 μ F ceramic capacitor across the load will decouple it. The capacitors should be connected as close to the load as possible.

Ground Loops

Ground loops occur when different circuits are given multiple paths to common or earth ground, as shown in Figure 57. Multiple ground points have slightly different potential and cause current flow through the circuit from one point to another. This can result in additional noise in all the circuits. To eliminate the problem, circuits should be designed with a single ground connection as shown in Figure 58.

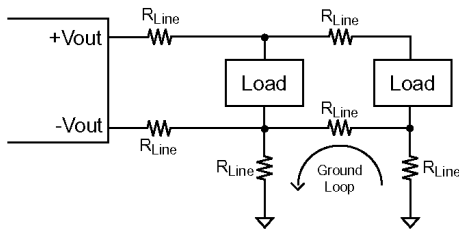

Fig. 57 Ground loops

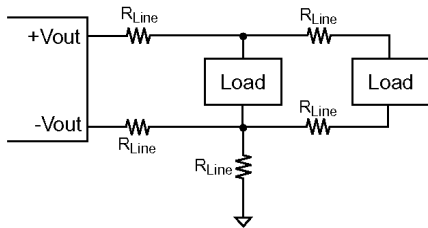

Fig. 58 Single point ground

Output Over-current Protection

AGQ100&AVQ100B DC/DC converters feature foldback current limiting as part of their OCP (Over-current Protection) circuits. When output current exceeds 110 to 140% of rated current, such as during a short circuit condition, the module will shut down and then enter a “hiccup mode” where it repeatedly turn on and off at a 100Hz(nominal) frequency with a 5% duty cycle until the short circuit condition is removed. This prevents excessive heating of the converter or the load board.

Output Over-Voltage Protection

The output over-voltage protection consists of circuitry that monitors the voltage on the output terminals. If the voltage on the output terminals exceeds the over voltage protection threshold, the module will shut down and then enter a “hiccup mode” where it repeatedly turn on and off at a 100Hz(nominal) frequency with a 40% duty cycle until the over-voltage condition is

removed. This prevents damage to the load circuit.

Over-Temperature Protection

The module feature an over-temperature protection circuit to safeguard against thermal damage. The module will work on intermittent mode when the maximum device reference temperature is exceeded. When the over-temperature condition is removed, the converter will automatically restart.

Input Reverse Voltage Protection

Under installation and cabling conditions where reverse polarity across the input may occur, reverse polarity protection is recommended. Protection can easily be provided as shown in Figure 59. In both cases the diode used is rated for 10A/100V. Placing the diode across the inputs rather than in-line with the input offers an advantage in that the diode only conducts in a reverse polarity condition, which increases circuit efficiency and thermal performance.

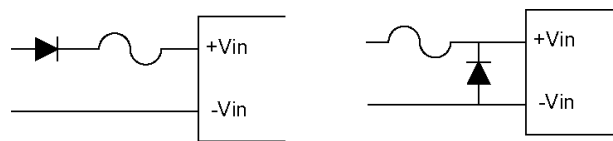

Fig. 59 Reverse polarity protection circuit

Safety Consideration

For safety-agency approval of the system in which the power module is used, the power module must be installed in compliance with the spacing and separation requirements of the end-use safety agency standard, i.e., UL1950, CSA C22.2 No. 950-95, and EN60950. The AGQ100&AVQ100B input-to-output isolation is a basic insulation. The DC/DC power module

should be installed in end-use equipment, in compliance with the requirements of the ultimate application, and is intended to be supplied by an isolated secondary circuit. When the supply to the DC/DC power module meets all the requirements for SELV (<60Vdc), the output is considered to remain within SELV limits (level 3). If connected to a 60Vdc power system, double or reinforced insulation must be provided in the power supply that isolates the input from any hazardous voltages, including the ac mains. One input pin and one output pin are to be grounded or both the input and output pins are to be kept floating. Single fault testing in the power supply must be performed in combination with the DC/DC power module to demonstrate that the output meets the requirement for SELV. The input pins of the module are not operator accessible.

Note: Do not ground either of the input pins of the module, without grounding one of the output pins. This may allow a non-SELV voltage to appear between the output pin and ground.

Fusing

The AGQ100&AVQ100B module have no internal fuse. An external fuse must always be employed! To meet international safety requirements, a 250 Volt rated fuse should be

used. If one of the input lines is connected to chassis ground, then the fuse must be placed in the other input line.

Standard safety agency regulations require input fusing. Recommended ratings is 5A for the AGQ100&AVQ100B.

Note: The fuse is fast blow type.

Typical Application

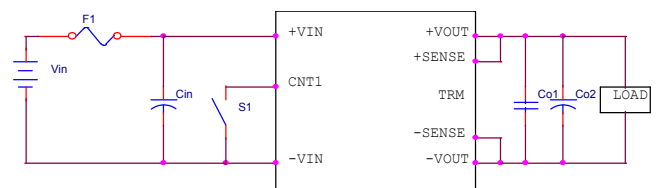

Fig. 60 Typical application

F1: Fuse*: 5A fuse (fast blow type) .

Cin: Recommended input capacitor, 100 μ F/100V high frequency low ESR electrolytic type capacitor.

Co1: Recommended 1 μ F /25V ceramic capacitor

Co2: Recommended output capacitor Recommended 1,000 μ F/25V high frequency low ESR electrolytic type capacitor.

If $T_a < -5^\circ\text{C}$: use 220 μ F tantalum capacitor parallel with Co2.

Note: The AGQ100&AVQ100B module cannot be used in parallel mode directly

EMC

For conditions where EMI is a concern, a different input filter can be used. Figure 61 shows a filter designed to reduce EMI effects for AGQ100&AVQ100B

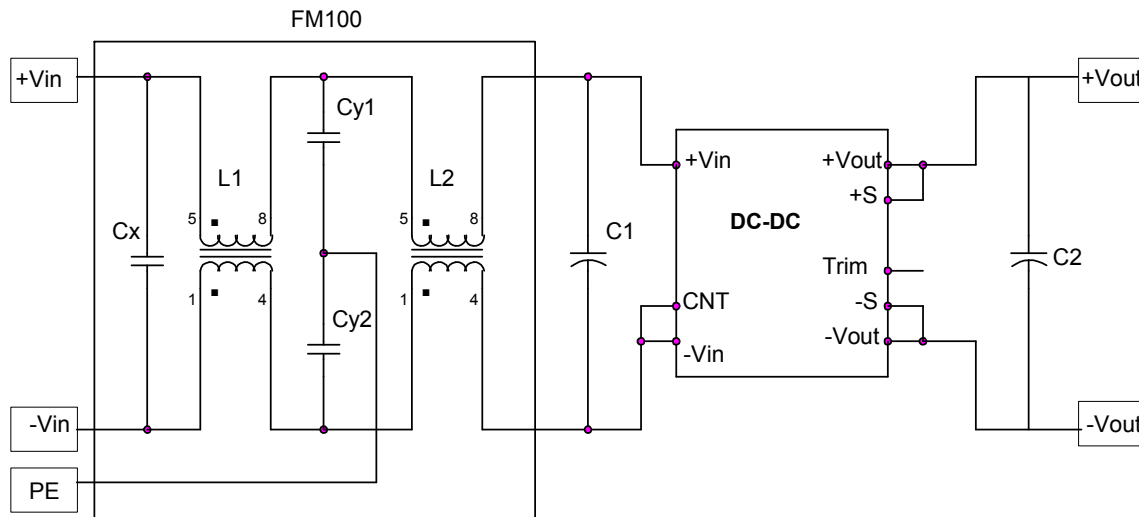

Figure 61 EMI reduction filter

Recommended values:

Component		Value/Rating	Type
C1		100 μ F/100V	Aluminium electrolytic capacitor
C2		220 μ F/25V	Aluminium electrolytic capacitor, low ESR
FM100 (Emerson Filter converter)	L1	150 μ H	Magnetic material: R10k dimension: T8.89 \times 3.81 \times 4.63 mm
	L2	480 μ H	Magnetic material: R10k dimension: T9.53 \times 4.75 \times 4.3 mm
	Cx	4.7 μ F/100V	Ceramic chip capacitor
	Cy1	4700pF/1500V	Leaded multilayer ceramic capacitor
	Cy2	4700pF/1500V	Leaded multilayer ceramic capacitor

Thermal Consideration

Thermal management is an important part of the system design. AVQ100&AVQ100B series module have ultra high efficiency at full load, and the module exhibit good performance during

pro-longed exposure to high temperatures. However, to ensure proper and reliable operation, sufficient cooling of the power module and power derating is needed over the entire temperature range of the module. Considerations includes ambient temperature, airflow, module power derating.

Measuring thermal reference point of the module as the method shown in Fig.62 can verify the proper cooling.

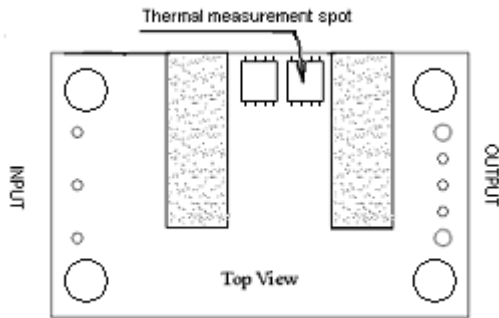

Fig.62 Temperature measurement location

Module Derating

When 48V input, 55 °C ambient temperature, and 200LFM airflow, AVQ100&AVQ100B series are rated for full power. For operation above ambient temperature of 55 °C, output power must be derated as shown in Fig.41 to 50, meantime, airflow at least 200LFM over the converter must be provided to make the module working properly.

It is recommended that the temperature of the thermal reference point be measured using a thermocouple. In order to operate inside the derating curves as shown Fig. 41 to 50, temperature on the PCB at the thermocouple location shown in Fig. 62 for a open frame module should not exceed 120 °C, and the temperature on the center of the base for a baseplate module should not exceed 110 °C.

The use of output power derating curve is shown in the following example.

Example

What is the minimum airflow necessary for a open frame AVQ100B-48S3V3 operating at $V_I = 48\text{ V}$, an output current of 25A, and a maximum ambient temperature of 55 °C

Solution

Given: $V_I = 48\text{V}$, $I_o = 25\text{A}$, $T_a = 55\text{ °C}$

Determine airflow (v) (use Fig.47): $v = 1\text{m/sec.}$ (200ft./min.)

Mechanical Considerations

Installation

Although AGQ100&AVQ100B converter can be mounted in any orientation, free air-flowing must be taken. Normally power components are always put at the end of the airflow path or have the separate airflow paths. This can keep other system equipment cooler and increase component life spans.

Note:

1. There should be no electrical connection between the case and the PE or any module ports.
2. The fixing screw of the heatsink should not be too long. Please refer to the mechanical chart for detail.

Soldering

AGQ&AVQ100B converter are compatible with standard wave soldering techniques. When wave soldering, the converter pins should be preheated for 20-30 seconds at 110 °C, and wave soldered at 260 °C for less than 10 seconds.

When hand soldering, the iron temperature should be maintained at 425 °C and applied to the converter pins for less than 5 seconds. Longer exposure can cause internal damage to the converter. Cleaning can be performed with cleaning solvent IPA or with water.

Assembly

The maximum length of the screw driven into the heat-sink is 3.3mm.

Mechanical Chart (Top & Side View)

Open frame

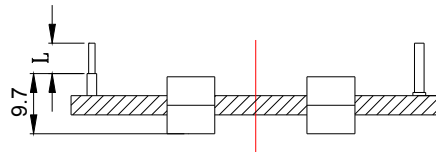
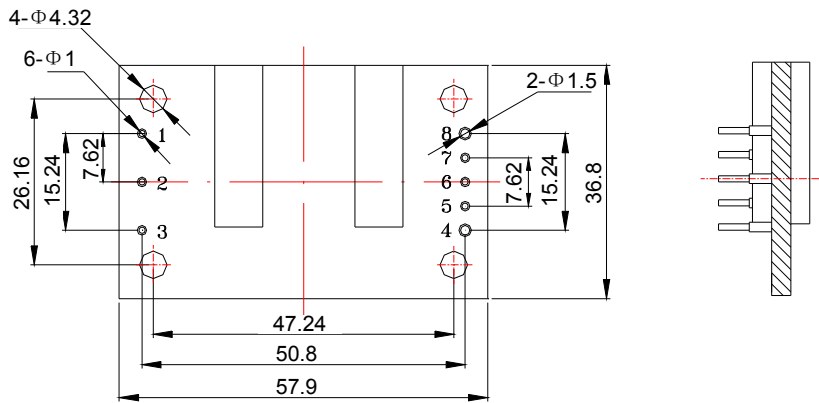

TOLERANCE: X.Xmm ± 0.5mm
X.XXmm ± 0.25mm

Pin Length Option

Device Code Suffix	L
-4	4.8mm ± 0.5mm
-6	3.8mm ± 0.5mm
-8	2.8mm ± 0.25mm
NONE	5.8mm ± 0.5mm

Baseplate

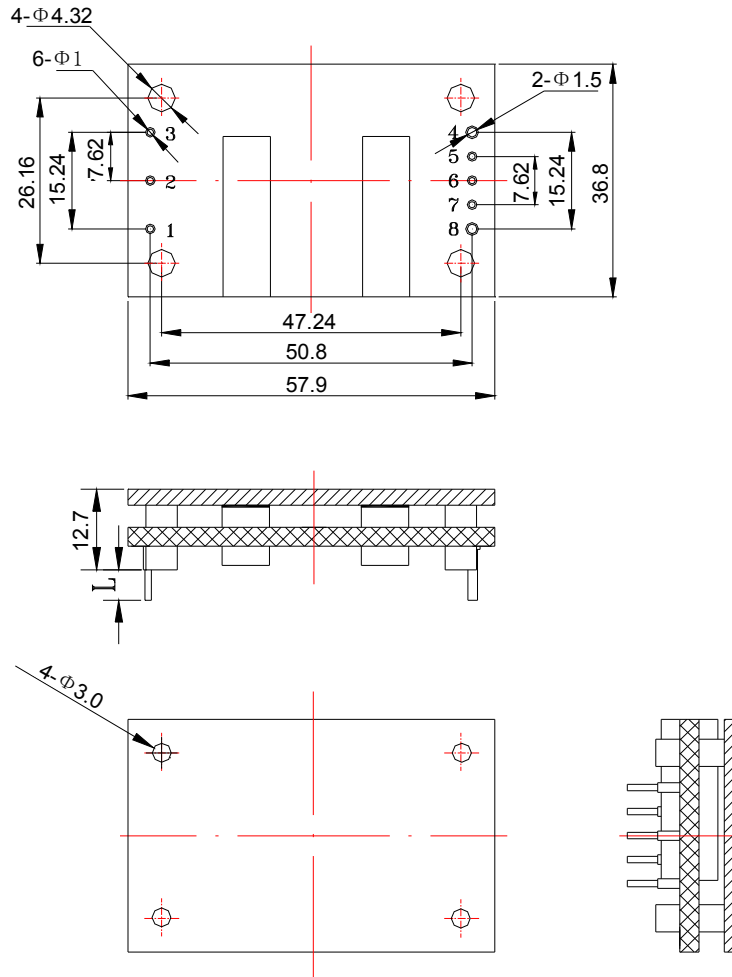

TOLERANCE: X.Xmm ± 0.5 mm
X.XXmm ± 0.25 mm

Pin Length Option

Device Code Suffix	L
-4	4.8mm ± 0.5 mm
-6	3.8mm ± 0.5 mm
-8	2.8mm ± 0.25 mm
NONE	5.8mm ± 0.5 mm

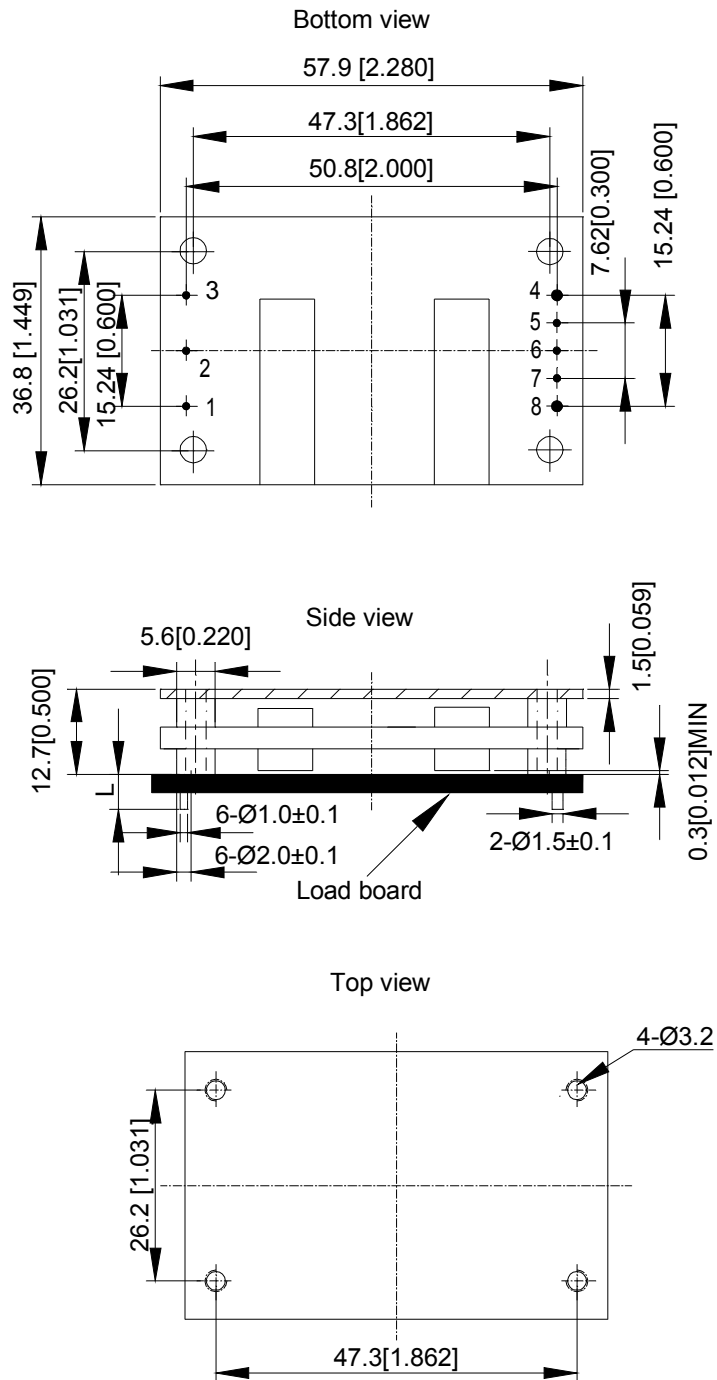

Unit: mm [inch] Bottom view: pin on upside

Tolerance: X.Xmm ± 0.5mm [X.X in. ± 0.02in.]

X.XXmm ± 0.25mm [X.XX in. ± 0.01in.]

Fig.63: AVQ100B-48S05/3V3PB-6L through holes baseplate profile

Pins definition

PIN NO.	FUNCTION	PIN NO.	FUNCTION
1	Vin(+)	4	Vo(-)
2	CNT	5	-SENSE
3	Vin(-)	6	TRIM
		7	+SENSE
		8	Vo(+)

Ordering Information

Model Number	Input Voltage (V)	Output Voltage (V)	Output Current (A)	Ripple and Noise (mV pp)	Efficiency (%) Typ.
				Typ.	
AGQ100-48S1V2	36~75	1.2	30	35	87
AGQ100-48S1V5	36~75	1.5	25	35	87.5
AGQ100-48S1V8	36~75	1.8	25	40	89
AVQ100B-48S3V3	36~75	3.3	25	50	91
AVQ100B-48S05	36~75	5.0	30	40	93

有毒有害物质或元素标识表

部件名称	有毒有害物质或元素					
	铅	汞	镉	六价铬	多溴联苯	多溴联苯醚
	Pb	Hg	Cd	Cr ⁶⁺	PBB	PBDE
制成板	○	○	○	○	○	○
○：表示该有毒有害物质在该部件所有均质材料中的含量在 SJ/T-11363-2006 规定的限量要求以下。 ×：表示该有毒有害物质至少在该部件的某一均质材料中的含量超出 SJ/T-11363-2006 规定的限量要求 艾默生网络能源有限公司一直致力于设计和制造环保的产品，我们会通过持续的研究来减少和消除产品中的有毒有害物质。以下部件或应用中含有有毒有害物质是限于目前的技术水平无法实现可靠的替代或者没有成熟的解决方案： <ol style="list-style-type: none"> 1. 焊料（含器件的高温焊料）中含有铅。 2. 电子器件的玻璃中含有铅。 3. 插针的铜合金中含有铅 						
适用范围：AGQ100&AVQ100B 全系列						

Looking for pricing, stock, or lifecycle information?

Click below to explore more details on WIN SOURCE:

- ⊖ [View AGQ100-48S1V5-4 on WIN SOURCE](#)
- ⊖ [Artesyn Embedded Technologies Information](#)

Optimize Your Supply Chain with WIN SOURCE Solutions

- ✓ Global Sourcing Solution
- ✓ Obsolete Management
- ✓ Cost Control Management
- ✓ Shortage Management
- ✓ Alternative Solution
- ✓ Excess Inventory Management